



Capacitive evaluation unit - KFA
Series *PER LEVEL*

PNP output

- For capacitive filling level probes with 1 limit value switching point:
KFS-5-1-...-15-Y55
KFS-5-1-“L”-15-AL-1” with plug connection Art.-No. 66101213
KFS 5-1-“L”-15-VA-1” with plug connection Art.-No. 66101213
- Operating voltage: 18...36 V DC
- With adjustable turn-off delay of 0...15 sec.

Certificate:



Technical data

Electrical version	4 wire DC
Output function	Antivalent
Type NPN	
Art. No	
Connection diagram No.	
Type PNP	
Art. No.	
Connection diagram No.	KFA-5-1-L-P-A-TD-Y50
Art. No.	
Connection diagram No.	AF 0075
Operating voltage (U_B)	18...36 V DC
Output current max. (I_o)	2 x 250 mA
Voltage drop max. (U_o)	≤ 2,5 V
Permitted ripple max.	40 %
No-load current (I_o)	Typ. 50 mA
Switching frequency max.	4 Hz
Permitted ambient temperature	-25...+55 °C
LED display	Green / yellow
Protection circuit	Built-in
Degree of protection IEC 60529	IP 54
Norm	EN 60947-5-2
Connection cable	2 m, PVC, 4 x 0,34 mm ²
Housing material	PA

All specifications are subject to change without notice. (22.02.2011)

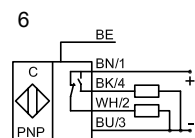
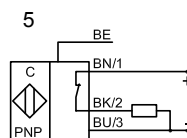
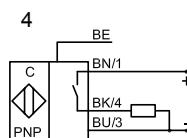
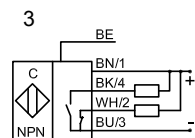
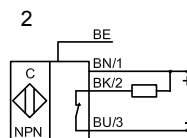
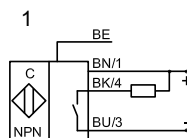
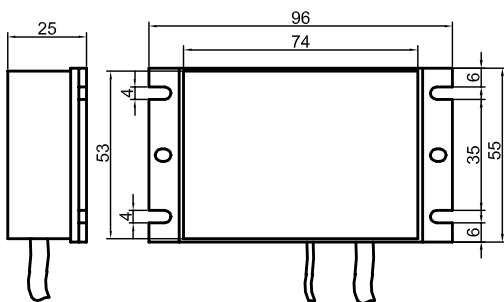

Made in Germany