

FT 25-R

Photoelectric diffuse sensor



PRODUCT HIGHLIGHTS

- Differentiates between even the slightest of grey value differences
- Sensor settings via teach-in and control input
- Simple alignment thanks to easily visible light spot
- Robust glass-fibre-reinforced plastic housings
- Durable laser printing
- Setting of smart functions via IO-Link

Optical data		Functions	
Scanning distance	0 ... 800 mm ¹	Indicator LED, green	Operating voltage indicator
Adjustment range	20 ... 800 mm ¹	Indicator LED, yellow	Switching output indicator
Type of light	LED, red, 632 nm	Sensitivity adjustment	Via Teach-in button, control input and IO-Link
Light spot size	See diagram	Teach-in modes	Mode 1: during running process Mode 2: during standing process
		Adjustment possibilities	N.O./N.C. and Auto-Detect / NPN / PNP via teach-in button, control input and IO-Link Button lock via control input and IO-Link Wide variety of adjustment possibilities via IO-Link
		Default settings	Max. scanning distance and N.O.
Electrical data		Mechanical data	
Operating voltage, +U _B	10 ... 30V DC ²	Dimensions	34 x 20 x 12 mm
No-load current, I ₀	≤ 30 mA	Enclosure rating	IP 69 & IP 67 ⁴
Output current, I _e	≤ 100 mA	Material, housing	ABS
Protective circuits	Reverse-polarity protection, U _B / short-circuit protection (Q)	Material, front screen	PMMA
Protection Class	2	Type of connection	See selection table
Power On Delay	< 300 ms	Ambient temperature: operation	-20 ... +60 °C ⁵
Switching output, Q	1x Auto-Detect (PNP/NPN) ³	Ambient temperature: storage	-20 ... +80 °C
Output function	N.O./N.C.	Weight (plug device)	10 g
Switching frequency, f (ti/tp 1:1)	≤ 1000 Hz	Weight (metal plug device ⁶)	10 g
Response time	500 μs	Weight (cable device)	40 g
Control input, IN	+ U _B = teach-in - U _B = button locked Open = normal operation	Weight (pigtail)	20 g
		Vibration and impact resistance	EN 60947-5-2
IO-Link			
Communication mode	COM 2		
Min. cycletime	2.3 ms		
SIO mode	Compatible		
Length process data	16 Bit		
Specification	1.1		

¹ Reference material: white, 90 % reflectivity ² Max. 10 % ripple, within U_B, ~ 50 Hz / 100 Hz ³ Auto-Detect, automatic PNP/NPN selection by the sensor; PNP or NPN fixed
⁴ With connected IP 67 / IP 69 plug ⁵ UL: -20 ... +50 °C ⁶ No Ecolab

Scanning distance	Switching output	Type of connection	Part number	Article number
0 ... 800 mm	Auto-Detect	Plug, M8x1, 4-pin, IO-Link	FT 25-R-PNSL-M4	607-21027
0 ... 800 mm	Auto-Detect	Metal plug, M8x1, 4-pin, IO-Link	FT 25-R-PNSL-M4M	607-21030
0 ... 800 mm	Auto-Detect	Cable, 2 m, 4-wire, IO-Link	FT 25-R-PNSL-K4	607-21028
0 ... 800 mm	Auto-Detect	Pigtail, 152 mm with plug, M8, 4-pin, IO-Link	FT 25-R-PNSL-KM4	607-21031
0 ... 800 mm	Auto-Detect	Pigtail, 150 mm with plug, M12, 4-pin, IO-Link	FT 25-R-PNSL-KL4	607-21029

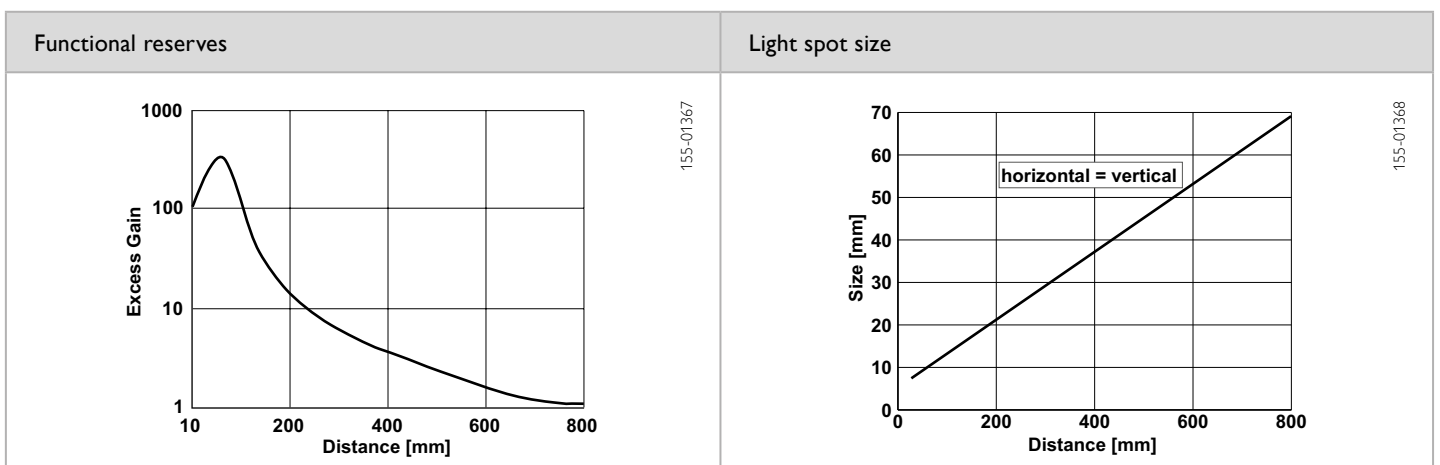
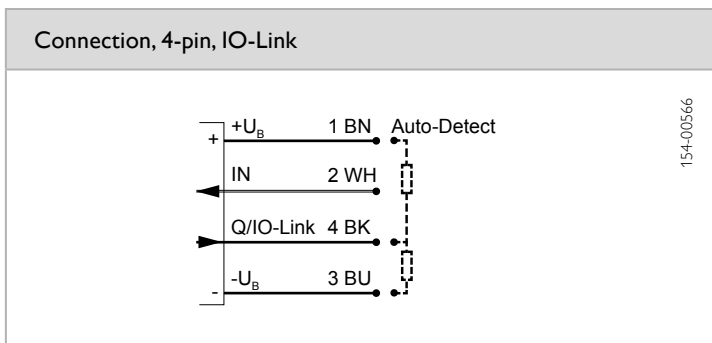
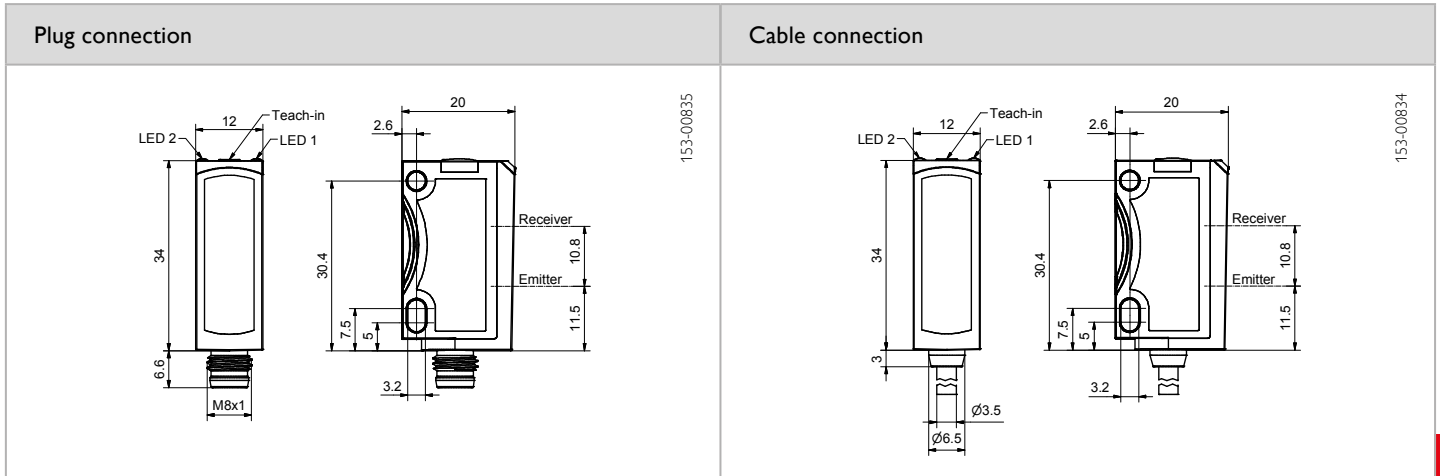

Reference material	Detection range	Accessories
White (90 %)	0 ... 800 mm	Connection cables
Grey (18 %)	1 ... 450 mm	Brackets
Black (6 %)	3 ... 250 mm	SensIO (901-01000)
		From Page A-38
		From Page A-4
		From Page A-56