

Power Quality Analyser UMG 512-PRO

User manual and technical data

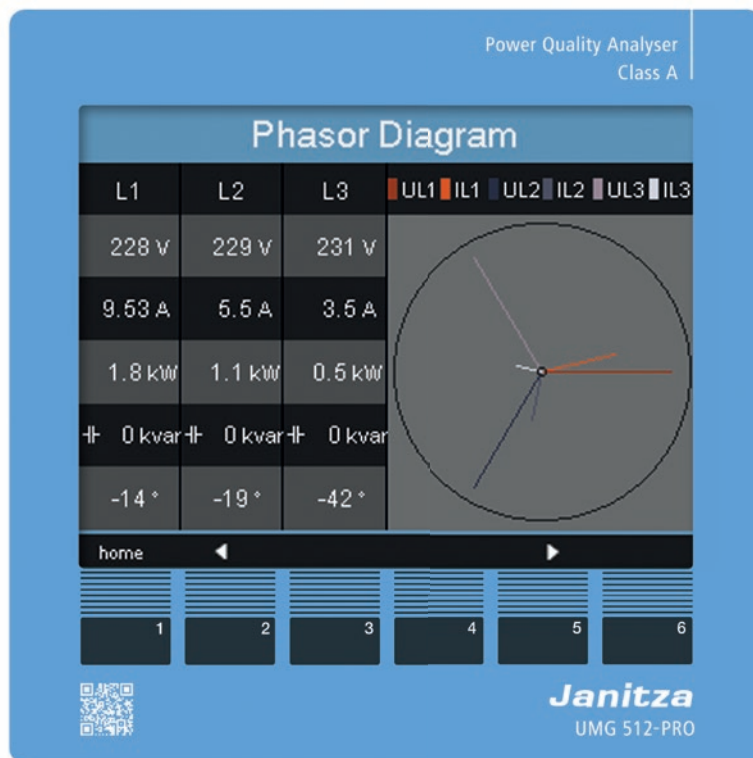

Janitza electronics GmbH
Vor dem Polstück 6
D-35633 Lahnau
Support tel. +49 6441 9642-22
Fax +49 6441 9642-30
e-mail: info@janitza.de
Internet: http://www.janitza.de

Janitza[®]

1.	Contents	
1.	General	1
1.1	Disclaimer	1
1.2	Copyright notice	1
1.3	Technical changes	1
1.4	Declaration of conformity	1
1.5	Comments on the manual	1
1.6	Meaning of symbols	1
2.	Safety	3
2.1	Safety information	3
2.2	Safety measures	4
2.3	Qualified staff	4
3.	Proper use	5
3.1	Inspection on receipt	5
3.2	Scope of delivery	6
3.3	Available accessories	6
4.	Product description	7
4.1	Measuring process	7
4.2	Usage concept	7
4.3	GridVis® network analysis software	7
4.4	Features	8
4.5	Product overview	9
5.	Installation	11
5.1	Position of installation	11
5.2	Mounting position	11
5.3	Mounting	11
6.	Network systems	13
6.1	Three-phase 3-conductor systems	14
6.2	Three-phase 4-conductor systems	14
6.3	Rated voltages	15

7.	Installation	17
7.1	Connection to a PC	17
7.2	Ground wire connection	18
7.3	Disconnectors	18
7.4	Supply voltage	18
7.5	Measured voltage	19
	7.5.1 Overvoltage	19
	7.5.2 Frequency	19
7.6	Current measurement	20
	7.6.2 Current direction	21
	7.6.3 Total current measurement	21
	7.6.1 Ammeter	21
7.7	Connection variants	22
	7.7.1 Baseline measurement	22
	7.7.2 Supporting measurement	24
7.8	Residual current monitoring	25
	7.8.1 Failure monitoring	25
	7.8.2 Example: Residual current transformer insulation	26
	7.8.3 Temperature measurement	27
	7.8.4 Example of temperature sensor insulation	27
8.	Interfaces	29
8.1	Shielding	29
8.2	RS485 interface	30
	8.2.1 Termination resistors	30
8.3	Profibus interface	31
	8.3.1 Connecting the bus lines	31
8.4	Bus structure	32
8.5	Ethernet interface	33
9.	Digital inputs and outputs	35
9.1	Digital inputs	35
	9.1.1 S0 pulse input	36
9.2	Digital outputs	37
10.	Operation	39
10.1	Button allocation	39
10.2	"Home" measured value indication	39
10.3	Measured value indication	40
	10.3.1 Main values	40
	10.3.2 By-values	40
10.4	Selecting a measured value indication	41
10.5	View additional information	42
10.6	Deleting values	42
10.7	Transients list	43
10.8	Event list	44

11.	Configuration	45
11.1	Languages	45
11.2	Communication	45
	11.2.1 Ethernet (TCP/IP)	46
	11.2.2 Field bus	46
11.3	Measurement	47
	11.3.1 Measuring transducer	48
	11.3.2 Transients	50
	11.3.3 Events	52
	11.3.4 Relevant voltage	53
	11.3.5 Nominal frequency	53
	11.3.6 Flicker	54
	11.3.7 Temperature	54
11.4	System	55
	11.4.1 Password	55
	11.4.2 Reset	56
11.5	Display	57
11.6	Colours	58
11.7	Extensions	59
12.	Commissioning	61
12.1	Supply voltage	61
12.2	Measured voltage	61
12.3	Frequency measurement	62
12.4	Phase sequence	62
12.5	Measured current	63
	12.5.1 Phasor diagram examples	64
12.6	Residual current	64
12.7	Failure monitoring (RCM)	65
	12.7.1 Alarm status	65
12.8	Measurement range exceeded	66
12.9	Checking the power measurement	66
12.10	Checking the communication	66
12.11	Communication in the bus system	67
	12.11.1 RS485	67
	12.11.2 Profibus	68
12.12	Digital inputs/outputs	73
	12.12.1 Digital inputs	73
	12.12.2 Pulse output	73

13.	Device homepage	77
13.1	Measured values	78
	13.1.1 Short overview	78
	13.1.2 Detailed measured values	79
	13.1.3 Diagrams	80
	13.1.4 RCM - residual current monitoring	80
	13.1.5 Events	81
13.2	Power quality	82
13.3	Apps	83
	13.3.1 Push Service	83
13.4	Information	84
	13.4.1 Device information	84
	13.4.2 Display	84
	13.4.3 Downloads	84
14.	Service and maintenance	85
14.1	Repair and calibration	85
14.2	Front film	85
14.3	Disposal	85
14.4	Service	85
14.5	Device calibration	85
14.6	Calibration intervals	85
14.7	Firmware update	85
14.8	Battery	86
15.	Procedure in the event of faults	87
16.	Technical data	89
16.1	Supply voltage	89
16.2	Voltage and current measurement	90
16.3	Residual current monitoring	91
16.4	Thermistor input	92
16.5	Digital inputs and outputs	93
16.6	Interfaces	94
16.7	Function parameters	95
	16.7.1 Measurements with 50/60 Hz	95
	16.7.2 Measurements in the range 15 to 440 Hz	96
16.8	Specifications as per IEC 61000-4-30	97
16.9	Dimension diagrams	98
17.	Menu guide overview	99
17.1	Configuration menu overview	99
17.2	Overview of measured value indications	100
18.	Connection example	103

1. General

1.1 Disclaimer

Observing the information products for the devices is the prerequisite for safe operation and in order to obtain the specified performance and product features. Janitza electronics GmbH accepts no liability for injuries to personnel, property damage or financial losses arising due to a failure to comply with the information products. Ensure that your information products are accessible and legible.

1.2 Copyright notice

© 2017 - Janitza electronics GmbH - Lahnau. All rights reserved.

Duplication, editing, dissemination and other utilisation, also in part, is prohibited. All trademarks and the resulting rights are the property of their respective owners.

1.3 Technical changes

- Please ensure that your device complies with the installation manual.
- Please read and understand the documents enclosed with the product first.
- Keep the documents enclosed with the product available throughout the entire service life of the product and pass them on to subsequent users if applicable.
- Inform yourself of any new device versions and the associated updates to the documentation enclosed with the product at www.janitza.de.

1.4 Declaration of conformity

For information on the laws, standards and directives that Janitza electronics GmbH has applied for the device, see the declaration of conformity on www.janitza.de.

1.5 Comments on the manual

We welcome your comments. If anything in this manual seems unclear, please let us know by sending us an **e-mail** to: info@janitza.de

1.6 Meaning of symbols

This manual uses the following pictograms:



Ground wire connection.



Inductive.

The current lags behind the voltage.



Capacitive.

The voltage lags behind the current.

2. Safety

Please read this user manual and all other publications that must be consulted to work with this product. This applies particularly to installation, operation and maintenance.

Observe all safety instructions and warnings. Failure to comply with the instructions can result in personal injuries and/or damage to the product.

Any unauthorised changes or use of this device, which go beyond the mechanical, electrical or otherwise stated operating limitations, can result in bodily injury and/or damage to the product.

Any such unauthorised change constitutes "misuse" and/or "negligence" according to the warranty for the product and thus excludes the warranty for covering possible damage resulting from this.

The user manual:

- must be read before using the device.
- must be kept throughout the entire service life of the product and be readily available for reference.

Follow additional legal and safety regulations required for the respective application when using the device.

2.1 Safety information

Symbols used:



This symbol is used as an addition to the safety instructions and warns of an electrical hazard.



This symbol with the word note describes:

- Procedures that do not pose any risk of injuries.
- Important information, procedures or handling steps.

Safety information is highlighted by a warning triangle and is indicated as follows depending on the degree of danger:



DANGER!

Indicates an imminent danger that causes severe or fatal injuries.



WARNING!

Indicates a potentially hazardous situation that can cause severe injuries or death.



CAUTION!

Indicates a potentially hazardous situation that can cause minor injuries or damage to property.

2.2 Safety measures

When operating electrical devices, certain parts of these devices are invariably subjected to hazardous voltage. Therefore, severe bodily injuries or damage to property can occur if they are not handled properly:



Risk of injury due to electric voltage!

WARNING!

Severe bodily injuries or death can occur due to dangerous voltages.

Therefore, note the following:

- **Before connecting connections, earth the device at the ground wire connection if present.**
- **Hazardous voltages may be present in all switching parts that are connected to the power supply.**
- **Hazardous voltages may also be present in the device even after disconnecting the supply voltage.**
- **Provide single core conductors with sleeves.**
- **Only connect screw-type terminals with a matching number of pins and of the same type.**
- **De-energise the system before starting work.**

2.3 Qualified staff

This device must only be operated and repaired by specialised personnel.

Specialised personnel are people who are qualified to recognise risks and prevent potential dangers that can be caused by the operation or maintenance of the device based on their respective training and experience.



Risk of injury due to improper use

WARNING!

If the device is not operated according to the documentation, protection is no longer ensured and hazards can be posed by the device.

3. Proper use

3.1 Inspection on receipt

The prerequisites of faultless, safe operation of this device are proper transport and proper storage, set-up and installation, as well as careful operation and maintenance.

Packing and unpacking must be carried out with customary care without the use of force and only using suitable tools.

Visually inspect the devices for flawless mechanical condition.

Please check the delivered items for completeness before you start installing the device.

If it can be assumed that risk-free operation is no longer possible, the device must be immediately put out of operation and secured against being put back into operation again. It can be assumed that risk-free operation is no longer possible if the device, for example:

- has visible damage,
- no longer works despite the mains power supply being intact
- has been exposed to prolonged adverse conditions (e.g. storage outside the permissible climate limits without being adapted to the room climate, condensation, etc.) or rough handling during transportation (e.g. falling from a height, even if there is no visible external damage, etc.)

**NOTE!**

All screw-type terminals included in the scope of delivery are attached to the device.

**NOTE!**

All supplied options and versions are described on the delivery note.

3.2 Scope of delivery

Number	Part no.	Designation
1	52.17.xxx ¹⁾	UMG 512-PRO
1	33.03.336	Installation manual
1	33.03.347	“GridVis software” quick guide
1	10.01.855	Screw-type terminal, pluggable, 2-pin (auxiliary supply)
1	10.01.847	Screw-type terminal, pluggable, 5-pin (voltage measurement 1-4)
1	10.01.853	Screw-type terminal, pluggable, 8-pin (current measurement 1-4)
1	10.01.873	Screw-type terminal, pluggable, 6-pin (digital inputs/outputs)
1	10.01.888	Screw-type terminal, pluggable, 7-pin (RCM, thermistor input)
1	10.01.859	Screw-type terminal, pluggable, 3-pin (RS 485)
1	08.01.505	2m patch cable, twisted, grey (UMG PC/switch connection)
1	52.19.301	Mounting clips

¹⁾ For the item number, see the delivery note

3.3 Available accessories

Part no.	Designation
21.01.102	CR2450 lithium battery, 3 V (approval according to UL 1642)
13.10.539	Profibus connector, 9-pin, D-SUB
13.10.543	Profibus connector, 9-pole, D-SUB, wound
29.01.903	Seal, 144 x 144

4. Product description

The device is:

- intended for measuring power quality according to EN61000-4-30 in building installations, on distribution units, circuit breakers and busbar trunking systems.
- suitable for installation in fixed and weatherproof switchboards in indoor areas.
- usable in 2, 3 and 4-conductor networks and in TN and TT networks.
- provided with external $\dots/1A$ or $\dots/5 A$ current transformers for current measurement.
- only suitable for measurements in medium and high-voltage networks via current and voltage transformers.
- suitable for use in residential and industrial applications.
- suitable for residual current monitoring (RCM) via external residual current transformers with a rated current of 30 mA.
- not an independent protective device against electric shocks.

The measurement results can be displayed, read out and further processed via the device's interfaces.

4.1 Measuring process

The device:

- measures continuously and calculates all effective values over a 200 ms interval.
- measures the real effective value (TRMS) of the voltages and currents connected to the measurement inputs.

4.2 Usage concept

You can program and call up the measured values via many routes using the device:

- **Directly on the device** via 6 buttons and the display.
- Using the **GridVis®** programming software.
- Using the **device homepage**.
- You can use the **Modbus protocol** to modify and call up the data using the Modbus address list. The list can be called up via the device's home page.

This operation manual only describes how to operate the device using the 6 buttons. The GridVis® network analysis software has its own "online help".

4.3 GridVis® network analysis software

You can use the GridVis® network analysis software that is available at www.janitza.de to program the device and read out data. To do this, a PC must be connected to the device via a serial interface (RS485/Ethernet).

You can use the GridVis® network analysis software to:

- program the device.
- configure and read out recordings.
- analyse the read out data according to EN 61000-2-4.
- save the data to a database.
- display measured values graphically.
- program customer-specific applications.



CAUTION!

Malfunction due to incorrect connection

If the device is connected incorrectly, incorrect measured values may be returned.

Therefore, note the following:

- **Measured voltages and measured currents must derive from the same network.**
- **Do not use the device to measure DC current.**
- **Earth active switchboards.**



CAUTION!

Risk of injury due to electric voltage

Residual current monitoring monitors residual currents via external current transformers and can trigger a warning impulse when a threshold value is exceeded. **The device is therefore not an independent protective device against electric shocks.**

4.4 Features

General

- Front panel integration device with dimensions 144 x 144 mm
- Connection via pluggable screw terminals
- Colour graphical display 320 x 240, 256 colours
- Operation via 6 buttons
- 4 voltage and 4 current measurement inputs
- 2 Residual current inputs with failure monitoring
- 1 Thermistor input
- 2 digital outputs and 2 digital inputs
- 16-bit A/D converter, memory 256 Mbyte Flash, SDRAM 32 Mbyte
- RS485 interface (Modbus RTU, slave, up to 115 kbps)
- Profibus DP/V0
- Ethernet (web server, e-mail)
- Capture more than 2000 measured values
- Clock and battery (with battery monitoring function)
- Working temperature range -10 °C to +55 °C

Measurement

- Measurement in TN and TT networks
- Continuous sampling of the voltage and current measurement inputs at 25.6 kHz
- Frequency range of the fundamental oscillation 15 Hz to 440 Hz
- Capture transients >39 µs and store up to approx. 330,000 sampling points
- Current metering range 0.001 to 7 Amps
- Real effective value measurement (TRMS)
- Continuous sampling of the voltage and current measurement inputs
- Continuous monitoring of residual currents with failure monitoring
- Temperature measurement
- Measurement of the power quality in accordance with DIN EN61000-4-30, Class A
- Flicker measurement in accordance with DIN EN61000-4-15:2011, Class F1
- Working measurement, measurement uncertainty in accordance with DIN EN50470-3:
 - Class C for/5 A converter
 - Class B for/1 A converter
- Measurement of harmonics 1 to 63 in accordance with DIN EN61000-4-7 Class 1, for:
 - Ull, Uln, I, P (consumption/supply)
 - Q (ind./cap.)
- Measurement of interharmonics 1 to 63 in accordance with DIN EN 61000-4-7 Class 1, for (Uln, Ull, I)
- Analysis and evaluation in accordance with DIN EN 50160 with the GridVis® programming software supplied as standard
- Programming separate applications in Jasic

4.5 Product overview

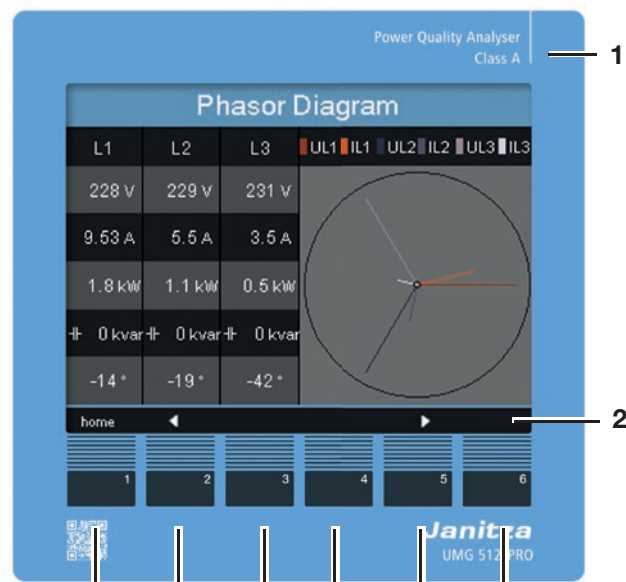

Fig. Front view of UMG 512 -PRO

- 1 Device type
- 2 Description of the function keys
- 3 Button 1: Configuration menu, back
- 4 Button 2: Select number, switch between main values
- 5 Button 3: Reduce the number by 1, select menu item
- 6 Button 4: Increase the number by 1, select menu item
- 7 Button 5: Select number, switch between main values
- 8 Button 6: Activate input, confirm selection

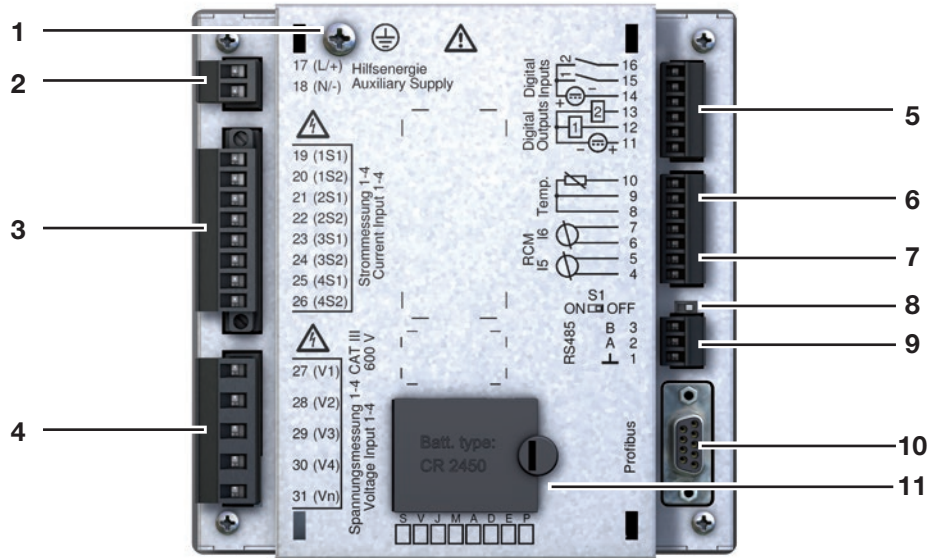

Fig. Rear view of UMG 512 -PRO

- 1 Ground wire connection
- 2 Supply voltage
- 3 Voltage measurement inputs V1 to V4
- 4 Current measurement inputs I1 to I4
- 5 Digital inputs / outputs
- 6 Thermistor inputs
- 7 Residual current monitoring inputs I5 and I6
- 8 DIP switch S1
- 9 RS485 interface
- 10 Profibus interface
- 11 Battery compartment

5. Installation

5.1 Position of installation

The device is suitable for installation in fixed and weatherproof switchboards in indoor areas.

Provide an earth for active switchboards.

CAUTION! Damage to property due to a failure to adhere to the installation instructions!

Failing to observe the installation instructions can damage or destroy your device. Adhere to the specifications for the installation position in sections “5. Installation” and “16. Technical data”.

5.2 Mounting position

The cut-out dimension in the switchboard is 138^{+0.8} mm x 138^{+0.8} mm.

To ensure adequate ventilation, adhere to the following specifications:

- install the device vertically.
- keep a gap of 50 mm at the top and bottom.
- keep a minimum gap of 20 mm.

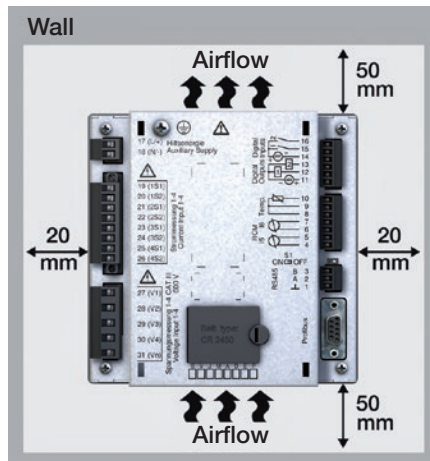

Fig. Rear view of the UMG 512-PRO installation position

5.3 Mounting

The device is mounted in the switchboard with two mounting clips at the top and bottom. Attach the mounting clips to the device in advance.

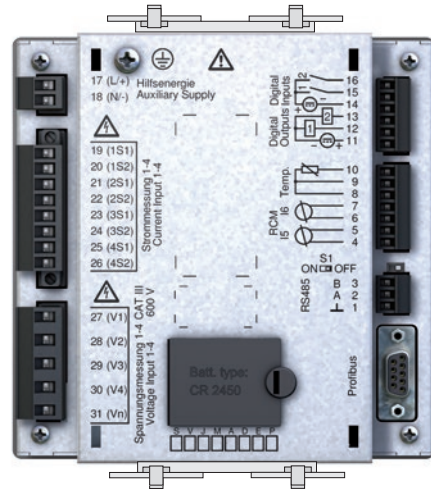

Fig. Arrangement of the mounting clips on the UMG 512-PRO

6. Network systems

Network systems and maximum rated voltages in accordance with DIN EN 61010-1/A1:

Three-phase four-conductor systems with earthed neutral conductor		Three-phase four-conductor systems with non-earthed neutral conductor (IT networks)		Three-phase three-conductor systems Not earthed		Three-phase three-conductor systems with earthed phase	
IEC	U_{L-N} / U_{L-L} : 417 VLN / 720 VLL	Only partially suitable for use in non-earthed networks				U_{L-L} 600 VLL	
UL	U_{L-N} / U_{L-L} : 347 VLN / 600 VLL						

Dual-phase two-conductor systems Not earthed		Single-phase two-conductor systems with earthed neutral conductor		Separated single-phase three-conductor system with earthed neutral conductor	
Only partially suitable for use in non-earthed networks		IEC	U_{L-N} 480 VLN	IEC	U_{L-N} / U_{L-L} : 400 VLN / 690 VLL
		UL	U_{L-N} 480 VLN	UL	U_{L-N} / U_{L-L} : 347 VLN / 600 VLL

Application areas for the device:

- 2, 3 and 4 conductor networks (TN and TT networks).
- In residential and industrial applications.



WARNING! Risk of injury due to electric voltage!

If the device is subjected to measurement voltage surges higher than the permissible overvoltage category, safety-relevant insulations in the device can be damaged, which means that the product's safety can no longer be guaranteed.

Only use the device in environments in which the permissible measurement voltage surge is not exceeded.

6.1 Three-phase 3-conductor systems

The device is only suitable to a limited extent for use in IT networks, as the measured voltage relative to the housing potential is measured and the input impedance of the device creates residual current against the earth. The residual current can trigger insulation monitoring in IT networks.

The connection variants with voltage transformers are suitable for unlimited use in IT networks.

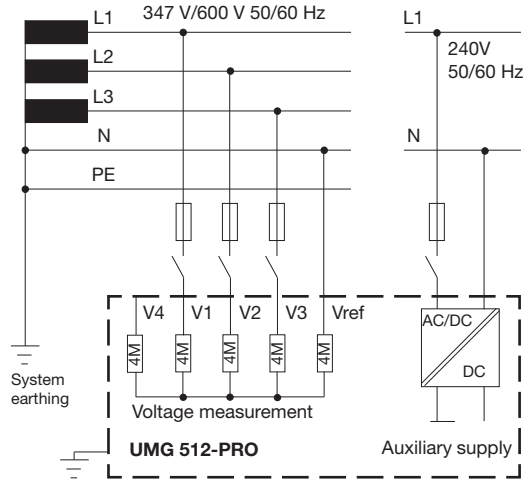

Fig. Schematic diagram, UMG 512-PRO in a TN network

6.2 Three-phase 4-conductor systems

The device can be used in three-phase 4-conductor systems (TN, TT networks) with an earthed neutral conductor. The bodies of the electrical system are earthed.

Voltage measurement in the device is designed for overvoltage category 600 V CAT III (measurement voltage surge 6 kV).

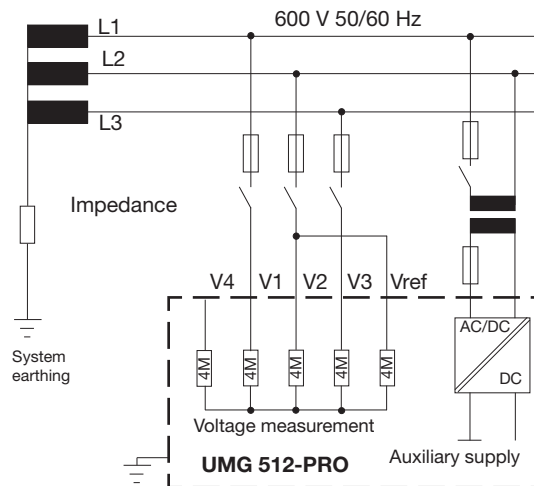

Fig. Schematic diagram, UMG 512-PRO in an IT network without N

6.3 Rated voltages

The following illustrations show lists of networks and the corresponding rated network voltages in which the device can be used.

U_{L-N} / U_{L-L}	
66V / 115V	
120V / 208V	
127V / 220V	
220V / 380V	
230V / 400V	
240V / 415V	
260V / 440V	
277V / 480V	Maximum network rated voltage according to UL
347V / 600V	
400V / 690V	
417V / 720V	Maximum network rated voltage

Fig. Rated network voltages that are suitable for measurement inputs in the **three-phase 4-conductor network with earthed neutral conductor** in accordance with EN 60664-1:2003

U_{L-L}	
66V	
115V	
120V	
127V	
200V	
220V	
230V	
240V	
260V	
277V	
347V	
380V	
400V	
415V	
440V	
480V	
500V	
577V	
600V	Maximum network rated voltage

Fig. Rated network voltages that are suitable for measurement inputs in the non-earthed **three-phase 3-conductor network** in accordance with EN 60664-1:2003

7. Installation

7.1 Connection to a PC

You have the following options for connecting the device to a PC:

1. Connection via an interface converter:

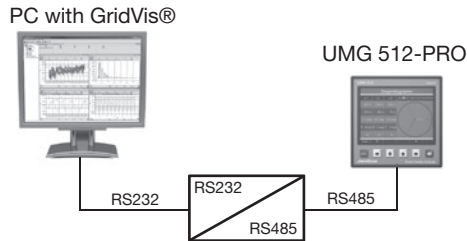

3. Connection via the network:

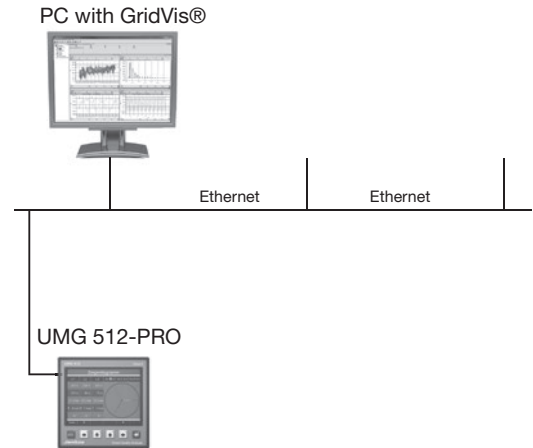

2. Direct connection via Ethernet:

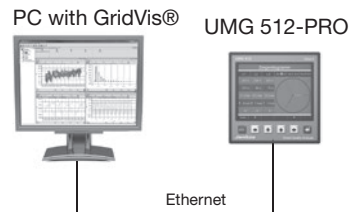

4. Using the UMG 512-PRO as a gateway for additional UMGs

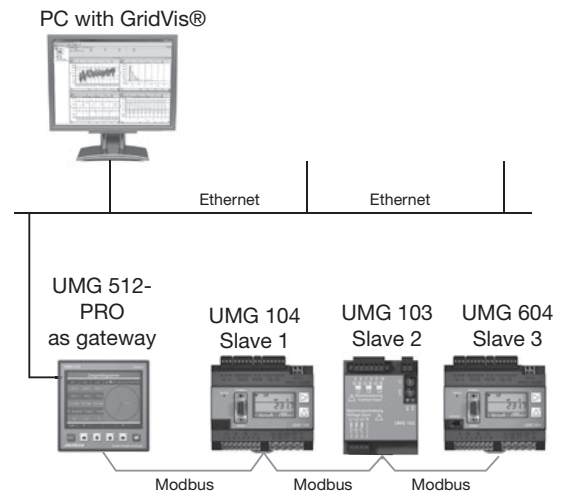

7.2 Ground wire connection

Use a ring cable lug to connect the ground wire connection to the device.

7.3 Disconnectors

During building installation, provide a suitable disconnector in order to disconnect the device from the current and voltage.

- Install the disconnector close to the device so that it is easily accessible to the user.
- Label the switch as a disconnection device.

7.4 Supply voltage

The device requires supply voltage to operate. The supply voltage level for your device is specified on the rating plate.

Before connecting the supply voltage, ensure that the voltage and frequency correspond to the details on the rating plate.

The supply voltage is connected via terminal blocks on the rear of the device.

Connect the supply voltage via a UL/IEC approved fuse.



CAUTION!

Damage to property due to not observing the connection conditions

Failure to observe the connection conditions can damage or destroy your device.

Therefore, note the following:

- Adhere to the specifications for voltage and frequency on the rating plate.
- Connect the supply voltage via a fuse in accordance with the technical data.
- Do not connect the supply voltage to the voltage transformers.
- Provide a fuse for the neutral conductor if the source's neutral conductor connection is not earthed.



WARNING!

Risk of injury due to electric voltage!

Severe bodily injuries or death can occur due to

- touching bare or stripped wires that are live,
- device inputs that are dangerous to touch.

Therefore, note the following:

- The inputs for the supply voltage are hazardous if touched!
- De-energise your system before starting the work!
- Connect the device's ground wire connection to the system earthing.

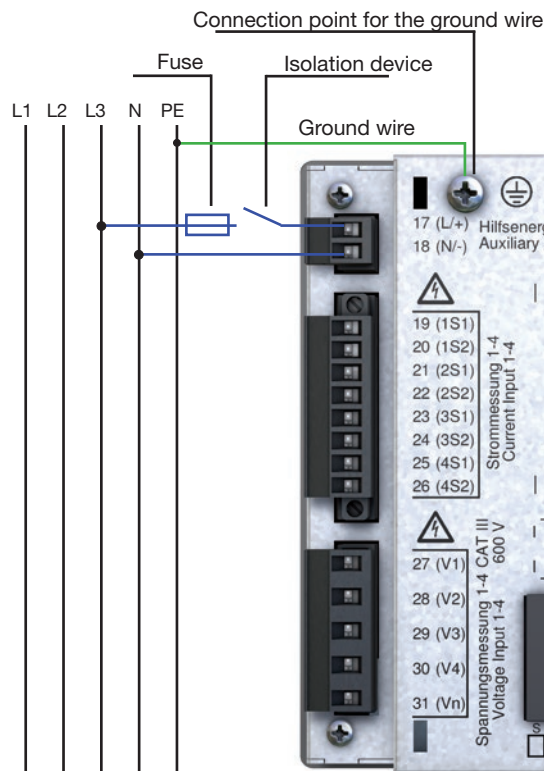

Fig. Example connection for the supply voltage

7.5 Measured voltage

The device has 4 voltage measurement inputs (V1 to V4) that are located on the rear of the device.

- V1 to V3 for the baseline measurement.
- V4 for the supporting measurement

The connections are called supporting and baseline measurement below.

7.5.1 Overvoltage

The voltage measurement inputs are suitable for measurements in networks where overvoltages of overvoltage category 600V CATIII can occur.

7.5.2 Frequency

The device

- is suitable for measurements in networks in which the fundamental oscillation of the voltage is in the range of 15Hz to 440Hz.
- only measures the frequency on the measurement inputs for baseline measurement.

To automatically determine (wide range) the mains frequency, an L1-N voltage of greater than 10 Veff must be applied to voltage measurement input V1.

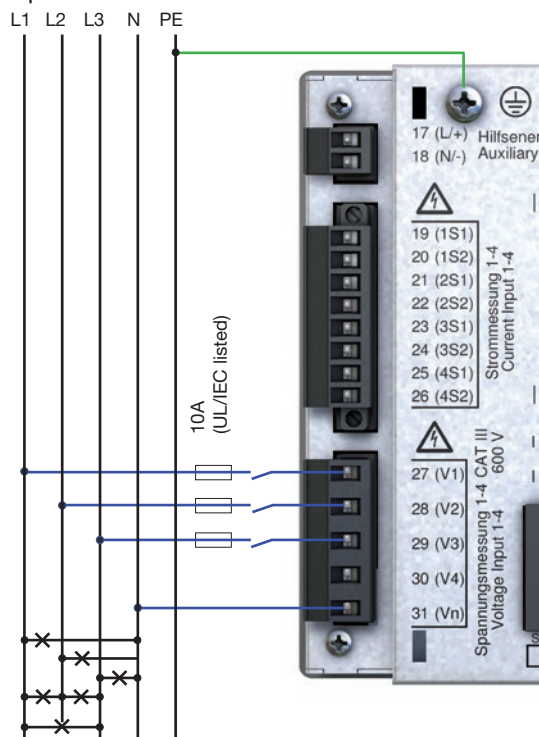

Fig. Connection example for voltage measurement.

CAUTION! **Malfunction due to incorrect connection**

If the device is connected incorrectly, incorrect measured values may be returned. **Therefore, note the following:**

- Measured voltages and currents must derive from the same network.
- The device is not suitable for measuring DC voltage.

WARNING! **Risk of injury due to electric voltage!**

Severe bodily injuries or death can occur due to a failure to observe the connection conditions for the voltage measurement inputs. **Therefore, note the following:**

- Do not use the device for voltage measurement in SELV circuits (safe extra low voltage).
- Connect the voltages higher than the permitted network rated voltages using voltage transformers.
- The voltage measurement inputs on the device are dangerous if touched!
- Install a disconnecter as described in “7. 3 Disconnectors”.
- Use a UL/IEC-approved overcurrent protection with a rated value, which is suitable for the short circuit current at the connection point.

NOTE!

When carrying out a baseline measurement on a three-phase 3-conductor network, the supporting measurement can no longer be used as a measurement input.

NOTE!

For measurement with the supporting measurement, a voltage must be connected to the baseline measurement for frequency determination.

7.6 Current measurement

The device:

- is intended for connecting current transformers with secondary currents of $\dots/1$ A and $\dots/5$ A.
- does not measure DC.
- has current measurement inputs that can be loaded with 120 A for 1 second.

The factory default for the current transformer ratio is 5/5 A and must be adapted to the current transformer employed if necessary.

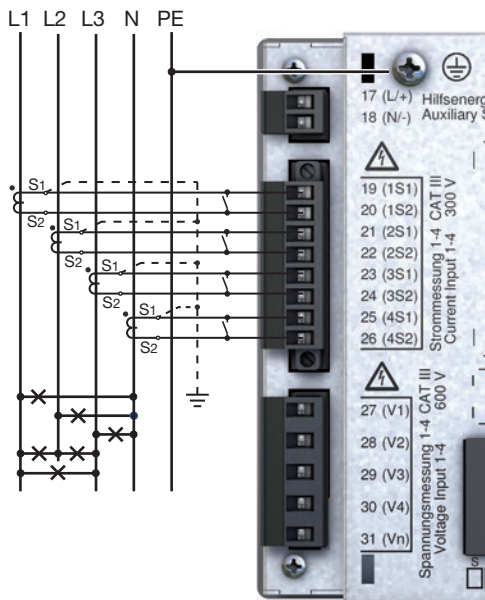

Fig. "Current measurement via current transformers" connection example.



WARNING!

Risk of injury due to electric voltage on current transformers!

On current transformers that are operated open on the secondary side, high voltage peaks that are dangerous to touch can occur, which can cause severe bodily injuries or death.

Therefore, note the following:

- **Avoid operating the current transformers open.**
- **Short circuit all unloaded current transformers.**
- **Connect the earthing connections provided on the current transformer to the earth.**
- **You must short circuit the secondary connections on the current transformer before interrupting the power supply.**
- **If a test switch, which automatically short-circuits the secondary wires of the current transformer is available, it is sufficient to set this to the "Test" position as long as the short-circuiting device has been checked beforehand.**
- **Only use current transformers that have a basic insulation in accordance with IEC 61010-1:2010.**
- **Ensure that the attached screw-type terminal is affixed to the device sufficiently using the two screws.**
- **Safe open-circuit current transformers are also dangerous to touch when they are operated open.**



WARNING!

Risk of injury due to electric voltage!

Temperatures of up to 80 °C can occur on the connections if there are high measured currents.

Therefore, use lines that are designed for an operating temperature of at least 80 °C

7. 6. 2 Current direction

You can correct the current direction on the device or via the existing serial interfaces for each phase individually. If the connection is incorrect, a subsequent re-connection of the current transformer is not required.

7. 6. 3 Total current measurement

For a summation measurement via two current transformers, first set their total transformation ratio on the device. For information on setting the current transformer ratios, see “11. 3. 1 Measuring transducer”.

Example:

The current is measured via two current transformers. Both current transformers have a transformation ratio of 1000/5 A. The summation measurement is performed using a 5+5/5 A total current transformer.

The device must then be set up as follows:

Primary current: 1000 A + 1000 A = 2000 A
 Secondary current: 5 A

7. 6. 1 Ammeter

If you wish to measure the current not only with the UMG but rather with an ammeter too, connect the ammeter to the UMG in series.

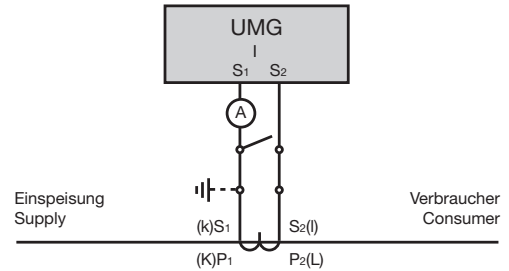

Fig. Circuit diagram with additional ammeter switched in series

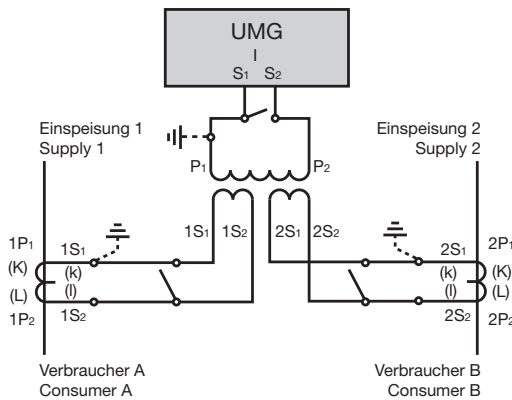
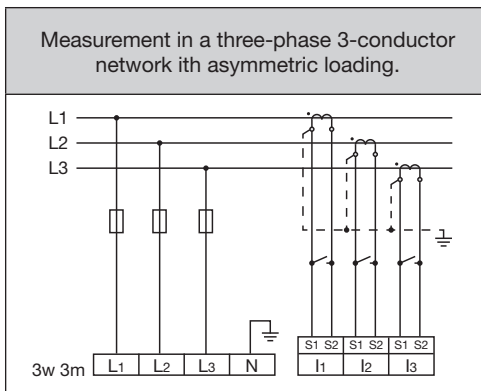
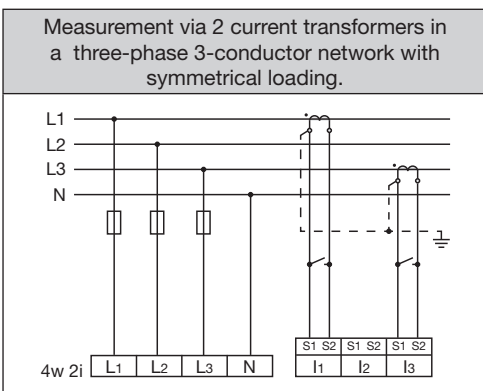
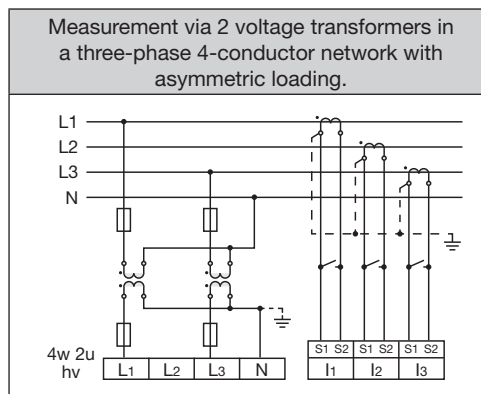
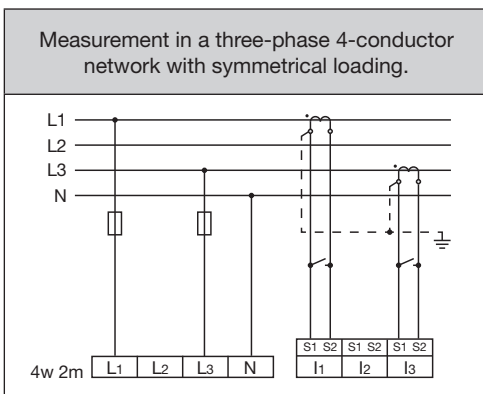
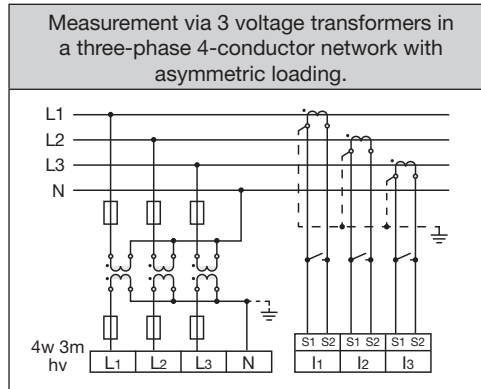
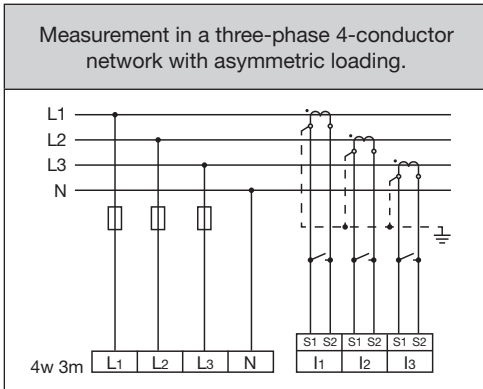

Fig. Example for current measurement via a total current transformer

7.7 Connection variants

7.7.1 Baseline measurement

Here, you can obtain various diagrams for the most common connection methods and the measured voltage on the device for baseline measurement.



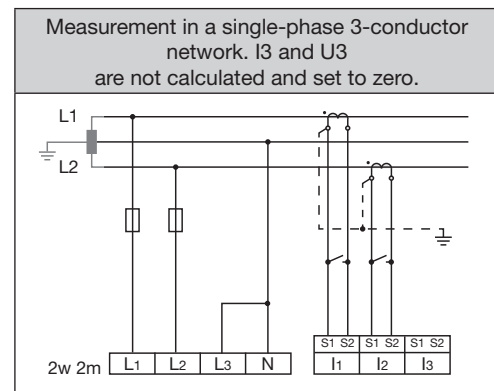
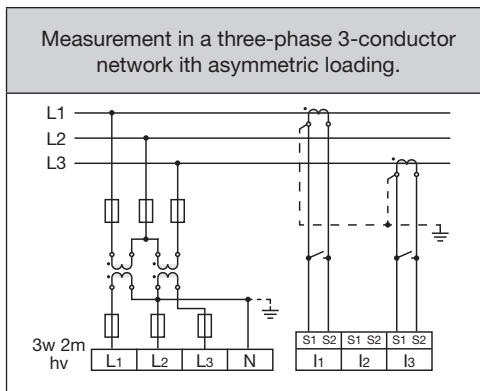
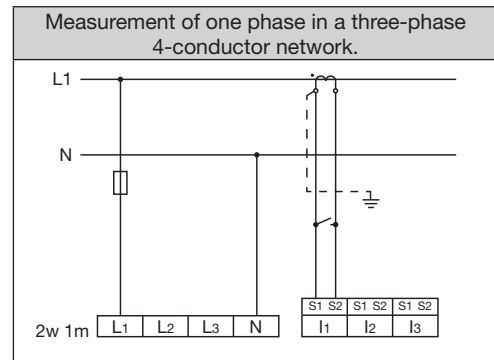
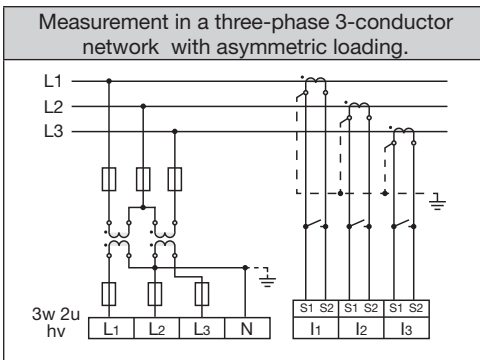
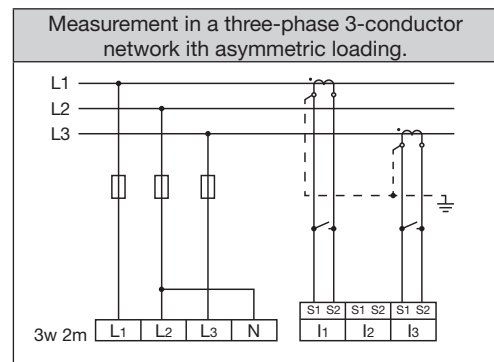
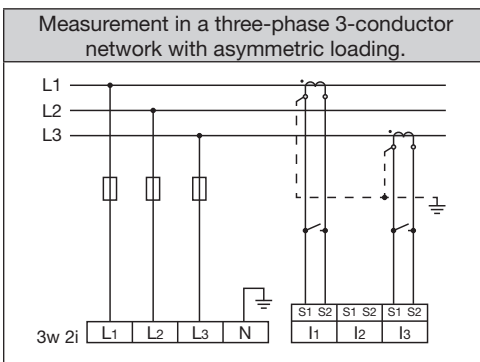
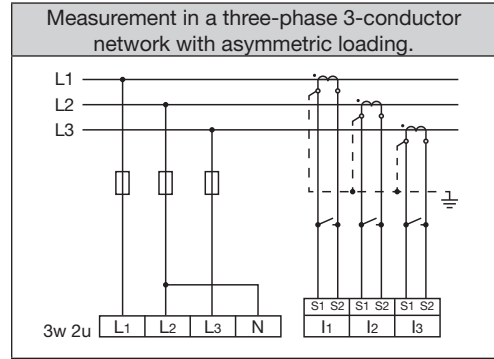
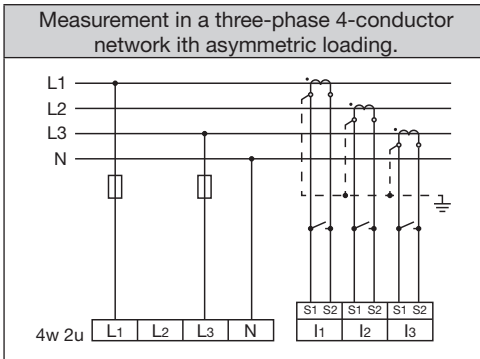

7.7.2 Supporting measurement

Measurement in a three-phase 4-conductor network with symmetrical loading.

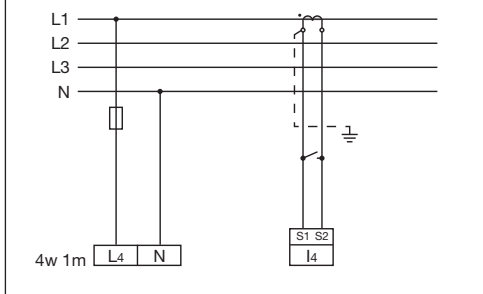

NOTE!

If the a baseline measurement is connected to a three-phase 3-conductor network, the supporting measurement can no longer be used as a measurement input.

NOTE!

For measurement with the supporting measurement, a voltage must be connected to the baseline measurement for frequency determination.

Measurement in a three-phase 3-conductor network with symmetrical loading.

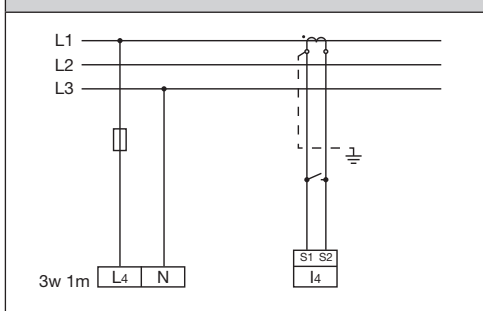

NOTE!

Measured voltages and measured currents must derive from the same network.

Measurement of the voltage between N and PE.
Measurement of the current in the neutral conductor.

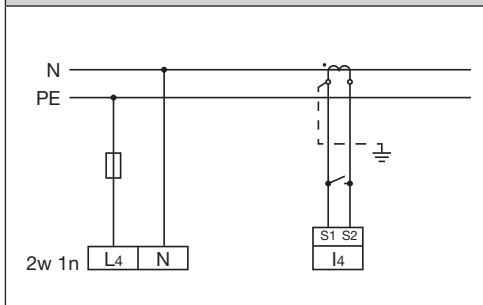

7.8 Residual current monitoring

The device:

- is suitable for use as a residual current monitoring device (RCM) as well as for monitoring AC, pulsing DC, and DC.
- can measure residual currents in accordance with IEC/TR 60755 (2008-01)  of type A.
- does not measure in a directionally sensitive manner. There is therefore no directional sensitivity of the residual currents on the network and load sides.

The connection of suitable external residual current transformers with a rated current of 30 mA is performed via the residual current transformer inputs I5 (terminals 4/5) and I6 (terminals 6/7).

7.8.1 Failure monitoring

The device monitors the ohmic resistance at the residual current measurement inputs.

If this is greater than 300 Ohm, residual current monitoring fails. This can occur due to a cable break for example

For further information on failure monitoring, see section “12.7 Failure monitoring (RCM)”.



CAUTION!

Risk of injury due to high voltages

Insufficient insulation of the operating equipment on the analogue inputs (temperature measurement and residual current monitoring) to the mains supply circuits can cause hazardous voltages on these inputs.

Ensure that there is reinforced or double insulation to the mains supply circuits!

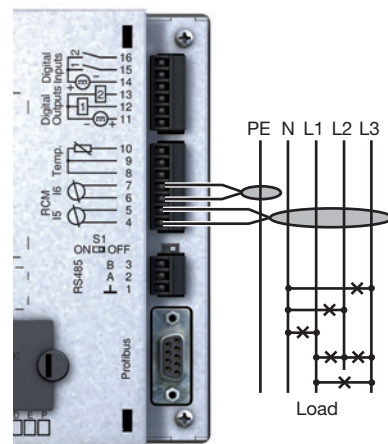



Fig. “Residual current monitoring via current transformers” connection variant



NOTE!

- The transformation ratios for the residual current transformer inputs can be configured via the GridVis® software. (see www.janitza.de)
- It is not necessary to configure a connection schematic for measurement inputs I5 and I6!

7.8.2 Example: Residual current transformer insulation

A residual current transformer should measure on isolated mains cables within a 300 V CAT III network.

The insulation of the mains cables and the insulation of the residual current transformer must fulfil the basic insulation requirements for 300 V CAT III.



CAUTION!

Transmission errors and damage to property due to electrical faults

If the line is longer than 30 m, there is an increased probability of transmission errors and damage to the device due to atmospheric discharge.

Use a shielded cable for connection to the residual current transformer.

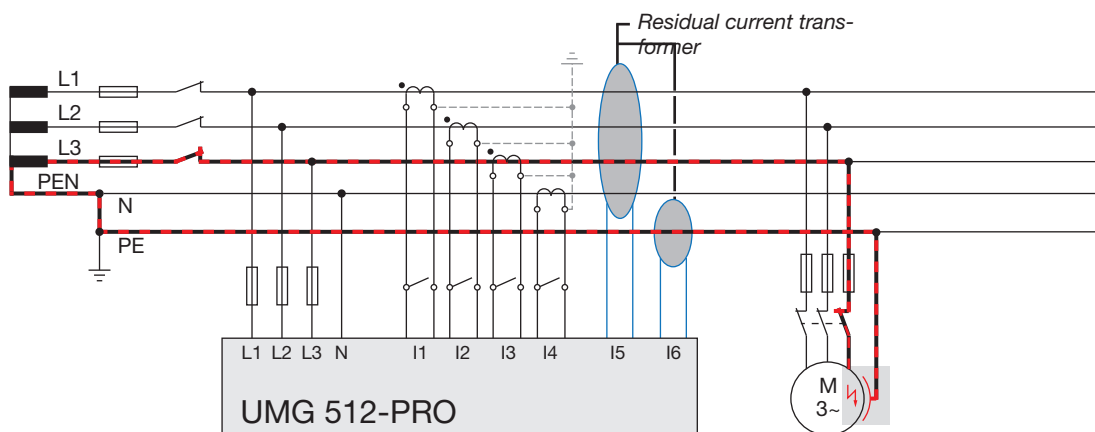

Fig. Example of a UMG 512-PRO with residual current monitoring via measuring inputs I5/I6.



WARNING!

Risk of injury due to electric voltage!

The Profibus, RS485, thermistor input and residual current monitoring input are not galvanically separated from each other.

Therefore, be aware that hazardous voltages on these inputs may have effects on the other connections.

7.8.3 Temperature measurement

The device has a thermistor input that is designed for a maximum total burden of 4 kOhm.

This refers to sensors and the line.

The temperature is measured here via terminals 8 to 10.

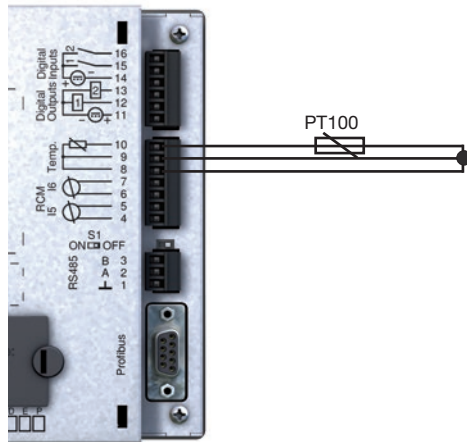

Fig. Connection example for temperature measurement with a PT100

7.8.4 Example of temperature sensor insulation

A temperature sensor in close proximity to non-insulated mains cables should measure within a 300V CAT III network.

The temperature sensor must be equipped with reinforced or double insulation for 300V CAT III.

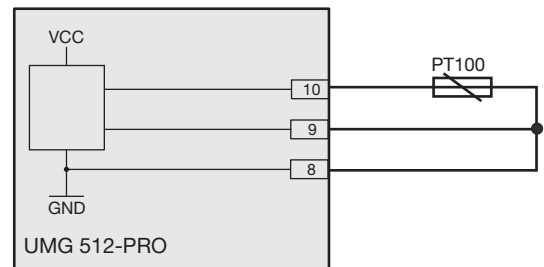



Fig. Schematic illustration of the connection example

CAUTION!  **Transmission errors and damage to property due to electrical faults**

If the line is longer than 30 m, there is an increased probability of transmission errors and damage to the device due to atmospheric discharge.

Use a shielded cable to connect to the temperature sensor.

CAUTION!  **Risk of injury due to high voltage**

Insufficient insulation of the operating equipment on the analogue inputs (temperature measurement and residual current monitoring) to the mains supply circuits can cause hazardous voltages on these inputs.

Ensure that there is reinforced or double insulation to the mains supply circuits!

WARNING!  **Risk of injury due to electric voltage!**

The Profibus, RS485, thermistor input and residual current monitoring input are not galvanically separated from each other.

Therefore, be aware that hazardous voltages on these inputs may have effects on the other connections.

8. Interfaces

The device has the following interfaces that can be used to connect it to other devices:

- RS485
- Profibus
- Ethernet

8.1 Shielding

Provide a twisted and shielded cable for connections via the interfaces and observe the following points for the shielding:

- Earth the shields of all cables that lead to the cabinet and at the cabinet entry.
- Connect the screens over a generous area and in a manner that will conduct well, to a low-noise earth.
- Gather the cables mechanically above the earthing clamp in order to avoid damage due to cable movements.
- Use suitable cable glands to feed the cables into the cabinet, for example, armoured conduit couplings.

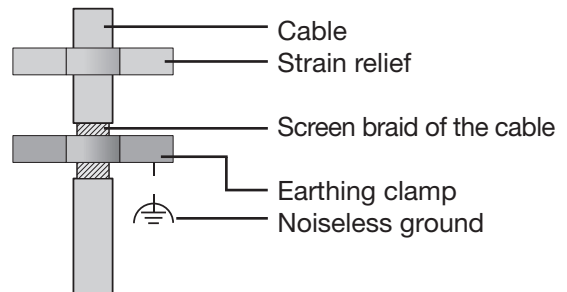

Fig. Shielding procedure at cabinet entry.



Transmission errors and risk of injury due to electrical faults

Atmospheric discharge can cause transmission errors and hazardous voltages on the device.

Therefore, note the following:

- **Connect the shielding to at least one functional earth (PE).**
- **If there are more significant sources of interference, connect the shield to the functional earth (PE) as close as possible to the device.**
- **Adhere to the maximum cable length of 12000 m at a baud rate of 38.4 K.**
- **Use shielded cables.**
- **Lay the interface lines with a spatial separation or with additional insulation to live system parts.**

8.2 RS485 interface

The RS485 interface on this device is designed as a 3-pin plug contact and communicates via the Modbus RTU protocol.

The cables used must be suitable for an environmental temperature of at least 80 °C.

Recommended cable types:

- Unitronic Li2YCY(TP) 2x2x0.22 (from Lapp Kabel)
- Unitronic BUS L2/FIP 1x2x0.64 (from Lapp Kabel)

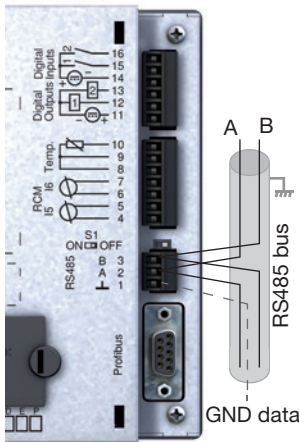

Fig. RS485 connection example

8.2.1 Termination resistors

The cable is terminated with resistors (120 Ohm 1/4 W) at the beginning and at the end of a segment.

Termination within the device is possible via the S1 DIP switch on the device.

To do this, move the S1 DIP switch into the middle to deactivate termination and to activate it at the end of the segment.

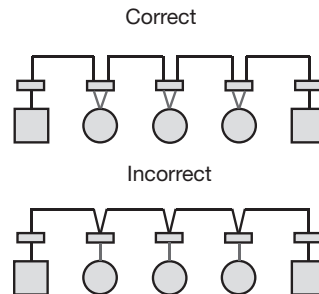

	Terminal strip in the cabinet.
	Device with RS485 interface. (without termination resistor)
	Device with RS485 interface. (with termination resistor on the device)

WARNING! **Risk of injury due to electric voltage!**

The Profibus, RS485 and the thermistor input are not galvanically separated from each other.

Therefore, be aware that hazardous voltages on these inputs may have effects on the other connections.

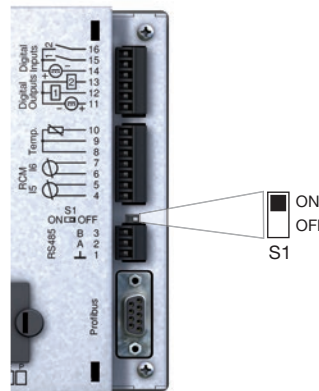

Fig. Termination via DIP switch activated (ON).

8.3 Profibus interface

This 9-pole D-sub receptacle RS485 interface supports the Profibus DP V0 slave protocol.

For a simple connection of inbound and outbound bus wiring, connect it to the device via a Profibus plug.

For the connection, we recommend a 9-pin Profibus connector, e.g. type "SUBCON-Plus-ProfIB/AX/SC" from Phoenix, item number 2744380. (Janitza item no.: 13.10.539)

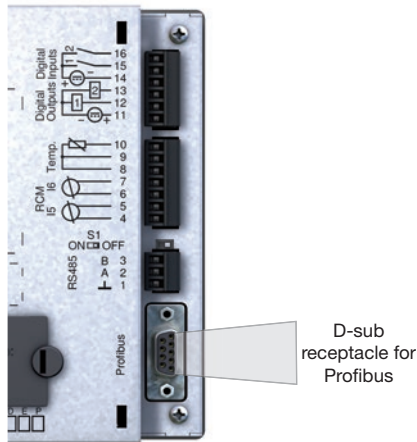

Fig. Rear view UMG 512-PRO with D-sub receptacle for Profibus



NOTE!

When using the device in a Profibus system, define the device address using the configuration menu as described in "11. 2. 2 Field bus"!

8.3.1 Connecting the bus lines

1. Connect the inbound bus line to terminals 1A and 1B on the Profibus connector.
2. Connect the continuing bus wiring for the next device in line to terminals 2A and 2B.
3. If there are no subsequent devices in the line, terminate the bus line with resistors by moving the switch on the Profibus connector to ON.

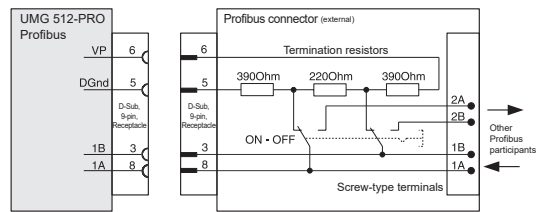

Fig. Profibus connector with termination resistors

Transmission speeds in kBit/s	max. segment length
9.6, 19.2, 45.45, 93.75	1200 m
187.5	1000 m
500	400 m
1,500	200 m
3000, 6000, 12000	100 m

Table Segment lengths per Profibus specification.



WARNING!

Risk of injury due to electric voltage!

The Profibus, RS485 and the thermistor input are not galvanically separated from each other.

Therefore, be aware that hazardous voltages on these inputs may have effects on the other connections.

8.4 Bus structure

- All devices are connected in a bus structure (line).
- Each device has its own address within the bus (also see programming parameters).
- Up to 32 participants can be connected together in a single segment.
- The cable is terminated with resistors (bus terminator, 120 Ohm, 1/4 W) at the beginning and at the end of a segment.
- If there are more than 32 participants, repeaters (amplifiers) must be used to connect the individual segments.
- Devices for which the bus connection is switched on must be under current.
- It is recommended that the master be placed at the end of a segment.
- If the master is replaced with a bus connection, the bus must be switched off.
- Replacing a slave with a bus connection that is either switched off or de-energised can destabilise the bus.
- Devices that are not connected to the bus can be replaced without destabilising the bus.

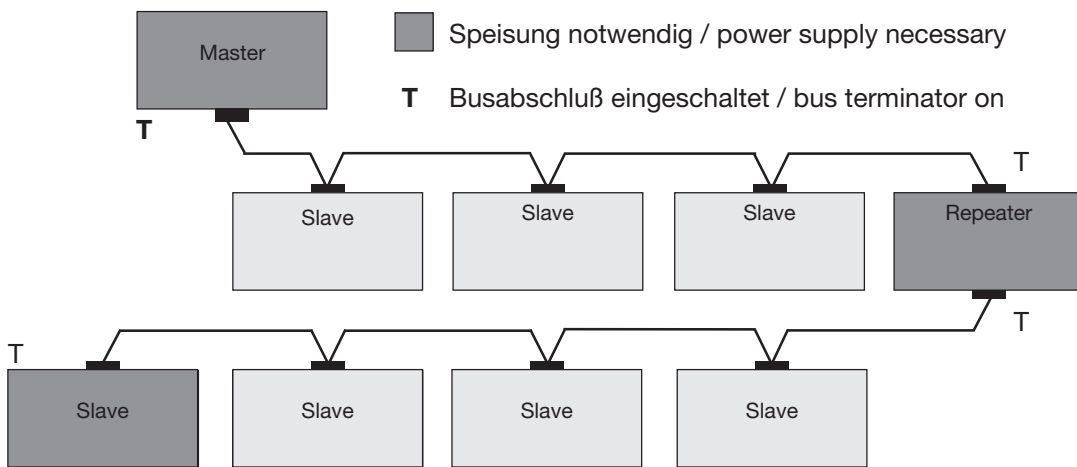

Fig. Bus structure illustration



NOTE!

CAT cables are not suitable for bus wiring. Use the recommended cable types for this.

8.5 Ethernet interface

The Ethernet interface is on the bottom of the device. When connecting, ensure that you provide a sufficient connection area depending on the bending radius and plug type for the Ethernet cable.

This connection area must not be smaller than 50 mm.

NOTE!

The device is factory-set to dynamic IP address allocation (**DHCP mode**). You can change these settings as described in “11. 2. 1 Ethernet (TCP/IP)” or using the GridVis® software. (see www.janitza.de)



CAUTION! Damage to property due to incorrect network settings

Incorrect network settings can cause faults in the IT network.

Before connecting the device, obtain information from your network administrator about the correct settings for your device.



NOTE!

We recommend using at least CAT5 cables for connection.

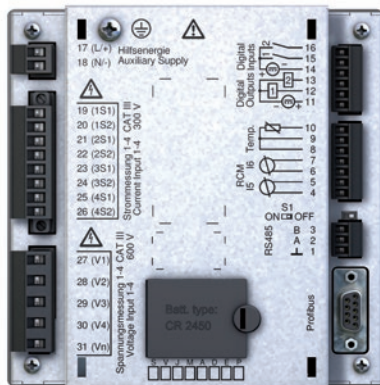

Ethernet connection

Patch cable

PC/switch

9. Digital inputs and outputs



CAUTION!

Transmission errors and damage to property due to electrical faults

If the line is longer than 30 m, there is an increased probability of transmission errors and damage to the device due to atmospheric discharge.

Use a shielded cable for connection to the digital inputs and outputs.

9.1 Digital inputs

The device has two digital inputs.

An input signal is detected on a digital input if a voltage of at least 18 V and maximum 28 V DC (typically at 4 mA) is applied.

There is no input signal for a voltage of 0 to 5 V and a current less than 0.5 mA.

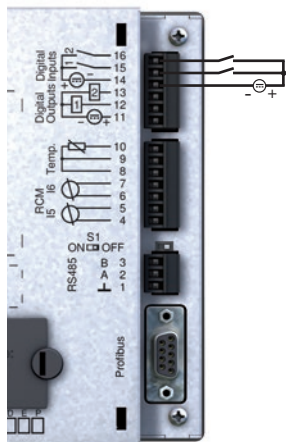

Fig. Connection of digital inputs



NOTE!

Pay attention to the supply voltage's polarity.

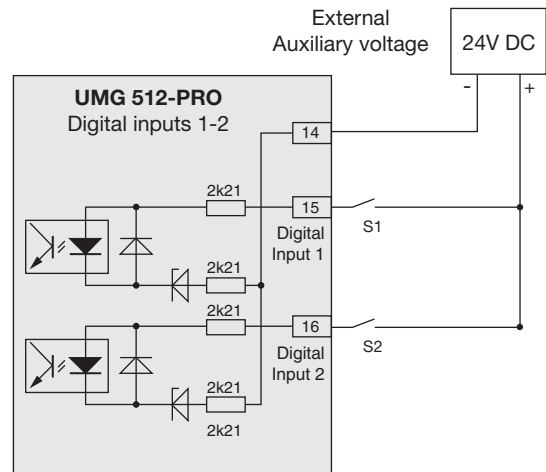

Fig. Example for connecting external contacts S1 and S2 to digital inputs 1 and 2

9. 1. 1 S0 pulse input

You can connect an S0 pulse transducer per DIN EN62053-31 to any digital input.

This requires an external auxilliary voltage with an output voltage in the range 18 to 28 V DC and a resistor of 1.5 kOhm.

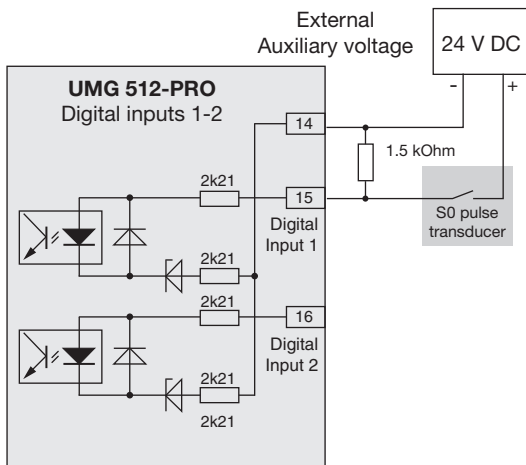

Fig. Example for connecting an S0 pulse transducer to digital input 1

9.2 Digital outputs

The device has two digital outputs, which:

- are galvanically separated from the analysis electronics using opto couplers.
- have a joint consumption.
- require an external auxiliary voltage.
- can be used as pulse outputs.
- can switch DC loads.

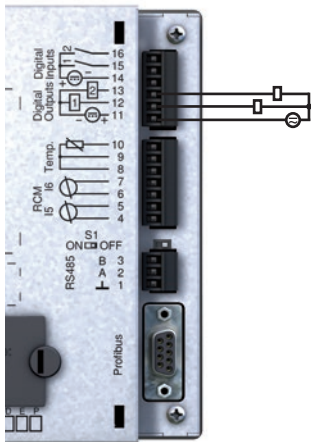

Fig. Connection of digital outputs



NOTE!

You can use the GridVis® software to set functions for the digital outputs clearly. (see www.janitza.de)



CAUTION! Measurement errors when using as a pulse output

When using the digital outputs as pulse outputs, measurement errors may arise due to the residual ripple.

Therefore, use a mains adapter for the supply voltage for the digital inputs and outputs, which has a residual ripple of less than 5% of the supply voltage.



CAUTION! Damage to property due to connection errors

The digital outputs are not short-circuit proof! Connection errors can therefore cause damage to the connections.

Ensure that the wiring is correct when connecting the outputs.

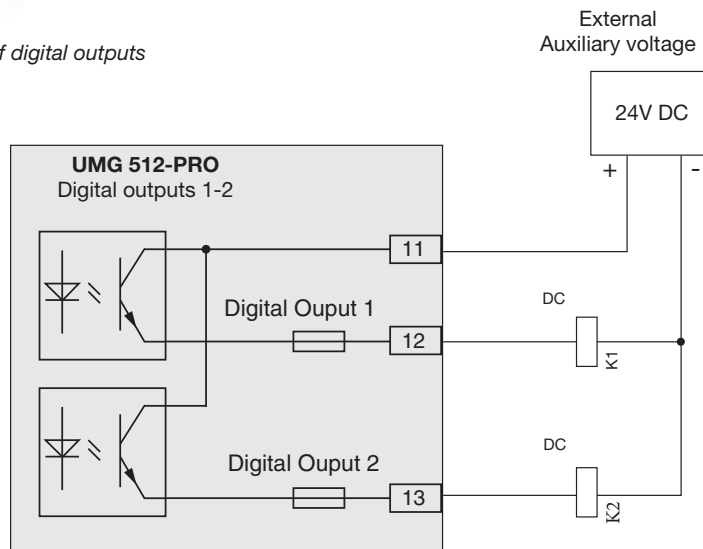

Fig. Example for connecting 2 relays to digital outputs 1 and 2

10. Operation

The device is operated via six function keys that have different functional assignments depending on the context:

- selecting measured value indications.
- navigation within the menus.
- editing device settings.

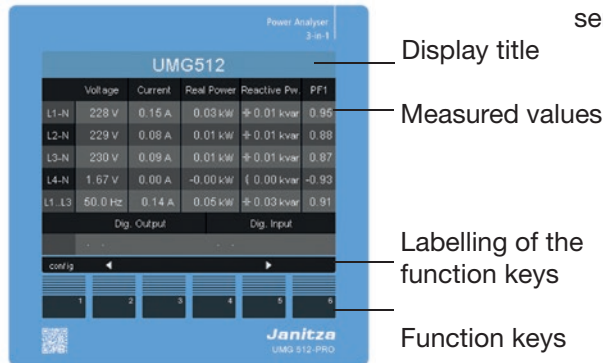

Fig. UMG 512-PRO "Home" measured value indication

10.2 "Home" measured value indication

After the power returns, the device starts with the "Home" measured value indication.

This measured value indication contains the device names and an overview of important measured values. In its delivery condition, the unit name consists of the device type and the serial number of the device.

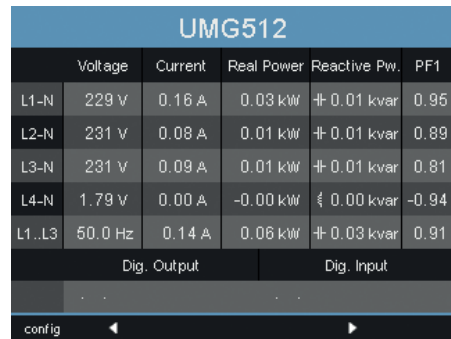

Fig. UMG 512-PRO "Home" measured value indication

10.1 Button allocation

Button	Function
1	<ul style="list-style-type: none"> • Returns to the first screen (home) • Exits selection menu
2	<ul style="list-style-type: none"> • Selects number • Selects main values (U, I, P ...)
3	<ul style="list-style-type: none"> • Changes (number -1) • By-values (select) • Selects menu item
4	<ul style="list-style-type: none"> • Changes (number +1) • By-values (select) • Selects menu item
5	<ul style="list-style-type: none"> • Selects number • Selects main values (U, I, P ...)
6	<ul style="list-style-type: none"> • Opens selection menu • Confirm selection

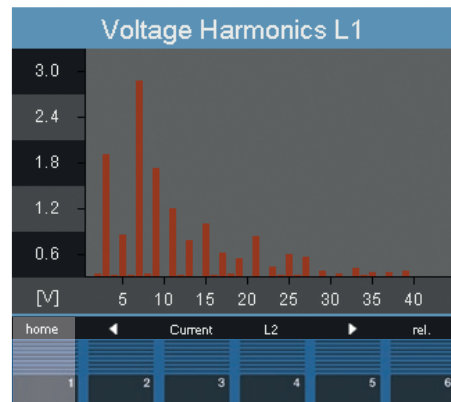

Fig. UMG 512-PRO Harmonics of voltage L1

Using the "Home - button 1", you navigate directly to the first "Home" measured value indication from the measured value indications for the main values

10.3 Measured value indication

10.3.1 Main values

Using buttons 2 and 5, you can scroll between the main values of the measured value indications. You can find an overview of the measured value indications in section “17.2 Overview of measured value indications”.

10.3.2 By-values

Using buttons 3 and 4, you can select the by-values of a measured value indication. These are also provided in the overview in section “17.2 Overview of measured value indications”.

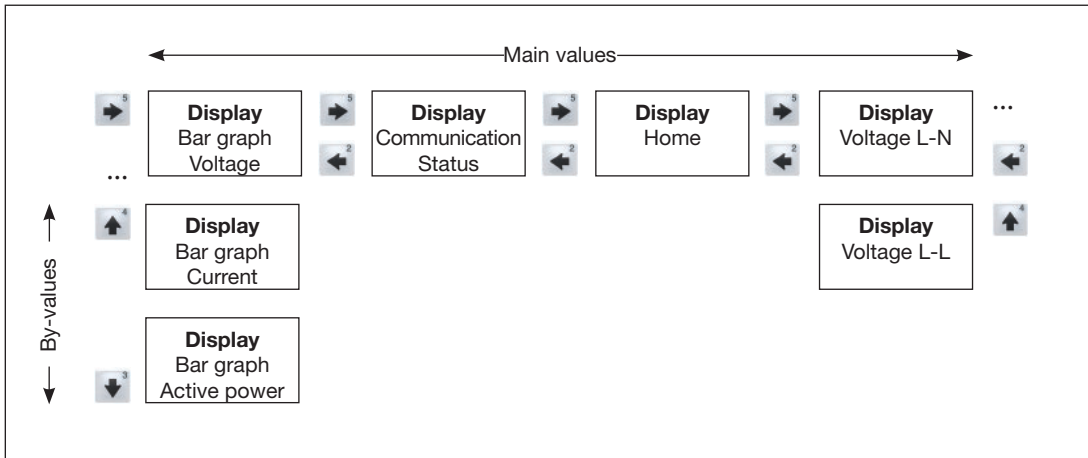

10.4 Selecting a measured value indication

In order to switch to a measured value indication with main values, use function keys 2 to 5 to select the required measured value indications with main values.

Using the 1 (home) function key, you always navigate to the first measured value indication.

Proceed as follows to switch to a measured value indication with by-values:

1. Select the measured value indication with the main values.
2. Use function keys 3 and 4 to select the measured value indication for the required by-values.

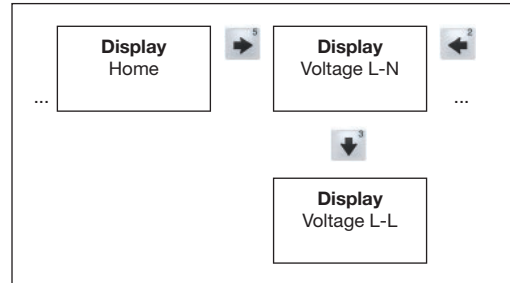

Fig. Example: Selecting the voltage by-values.

Voltage L-N			
	Value	Min Value	Max Value
L1-N	227 V	0.01 V	236 V
L2-N	228 V	0.01 V	237 V
L3-N	228 V	0.01 V	237 V
L4-N	1.12 V	0.01 V	1.69 V

home ◀ L-L ▶ select

1 2 3 4 5 6

↓

Voltage L-L			
	Value	Min Value	Max Value
L1-L2	394 V	0.01 V	409 V
L2-L3	395 V	0.01 V	410 V
L3-L1	394 V	0.01 V	409 V
L4-N	1.20 V	0.01 V	1.69 V

home ◀ L-N ▶ select

Fig. Selecting a measured value indication

10.5 View additional information

Proceed as follows to view additional information such as the power factor and frequency:

- Using the 2 and 5 keys, scroll to the desired measured value indication.
- Activate the measured value selection using the 6 key (select).
 - The background colour for the measured value switches from grey to blue.
 The additional information is displayed in an extra window.
- Using the 2 and 5 keys, select the desired measured value.
- End the procedure using the 1 key (ESC) or select another measured value with the 2 to 5 keys.

Voltage L-N			
	Value	Min Value	Max Value
L1-N	227 V	0.01 V	236 V
L2-N	228 V	0.01 V	237 V
L3-N	228 V	0.01 V	237 V
L4-N	1.12 V	0.01 V	1.69 V

home ◀ L-L ▶ select

1 2 3 4 5 6

Voltage L-N			
	Value	Min Value	Max Value
L1-N	227 V	0.01 V	236 V
L2-N	THD 1.8 % Power Factor 0.98 Frequency 50.01 Hz	0.01 V	237 V
L3-N	229 V	0.01 V	237 V
L4-N	1.10 V	0.01 V	1.69 V

esc ◀ ▶

Fig. Additional information for L1-N voltage

10.6 Deleting values

Proceed as follows to delete individual minimum and maximum values:

- Using the 2 and 5 keys, scroll to the desired measured value indication.
- Activate the measured value selection using the 6 key (select).
 - The background colour for the measured value switches from grey to blue.
 The additional information is displayed in an extra window.
- Using the 2 and 5 keys, select the desired minimum or maximum value.
 - The time along with the date and time of the occurrence are displayed as additional information.
- Using the 6 key (reset), you can delete the selected minimum or maximum value.
- End the procedure using button 1 (ESC) or select another minimum or maximum value with buttons 2 to 5.



NOTE!

The date and time for the minimum/maximum values are specified displayed in UTC.

10.7 Transients list

Transient voltages:

- are fast impulse transient effects in electrical networks.
- are unpredictable from a time perspective and have a limited duration.
- are caused by lightning strikes, switching operations or by tripped fuses.

A total of 16 detected transients are listed in the 2-page transients list for the device.

Proceed as follows to display a specific transient voltage:

1. Use buttons 2 and 5 to scroll to the "Transients" main value display
2. Select the desired page using button 4.
3. Use button 6 (selection) to access the transients list.
 - The background colour for the date/time switches from grey to blue.
4. Press button 3 or 4 to select a transient.
5. Use button 6 (select) to display a transient graphically.
6. Press button 6 (key) again to show or hide the key.
7. You can exit the transient graph display using button 1 (ESC).

Transients (1..8)		
Phase	Reason	Date/Time
L1	delta	2017 May 9 09:33:44,404
L1	delta	2017 May 4 06:16:49,553
L1	absolut	2017 May 3 12:21:44,971
L1	absolut	2017 May 3 12:21:44,901
L1	absolut	2017 May 3 12:21:44,830
L1	absolut	2017 May 3 12:21:44,760
L1	absolut	2017 May 3 12:21:44,691
L1	absolut	2017 May 3 12:21:44,622

esc ▼ ▲ enter

1 2 3 4 5 6

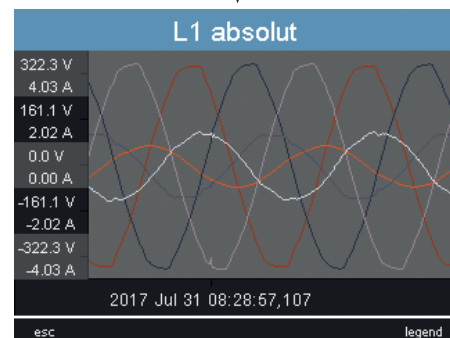

Fig. Displaying a transient

10.8 Event list

Events are threshold value violations of effective current and voltage values.

A total of 16 detected events are listed in the two-page event list for the device.

Proceed as follows to display a specific event:

1. Use buttons 2 and 5 to scroll to the "Events" main value display.
2. Select the desired page using button 4.
3. Use button 6 (selection) to access event list.
 - The background colour for the date/time switches from grey to blue.
4. Press button 3 or 4 to select an event.
5. Use button 6 (select) to display an event graphically.
6. Press button 6 (key) again to show or hide the key.
7. You can exit the event's graphical display using button 1 (ESC).

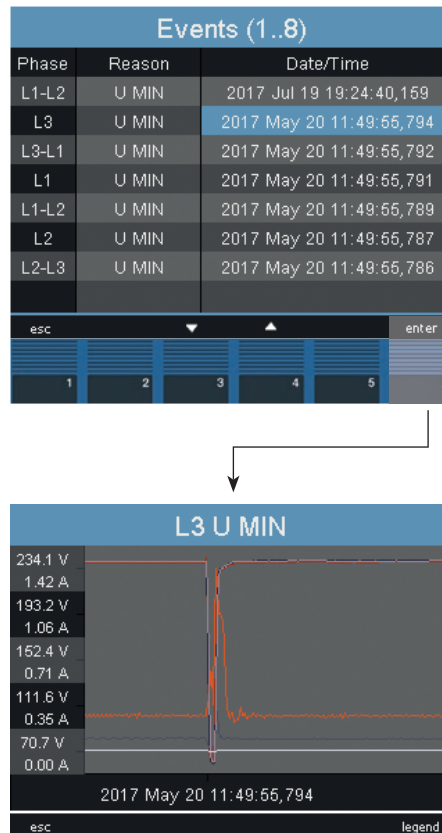

Fig. Displaying an event

11. Configuration

The supply voltage must be connected to configure the device. Proceed as described in "12. 1 Supply voltage".

To call the configuration menu, press button 1 on the "Home" measured value indication.

11.1 Languages

You can set the language for the measured value indications and menus directly in the "Configuration" menu.

There are different languages available for selection. The factory default setting for the language is "English".

Proceed as follows to change the system language:

1. Open the configuration menu.
2. Press button 3 or 4 until the language field has a coloured background.
3. Press button 6 (enter) to open the language selection.
4. Press button 3 or 4 to select the desired language.
5. Press button 6 (enter) again to confirm your selection.

11.2 Communication

You can configure the Ethernet and RS485 interface for your device in the communication menu.

Proceed as follows to access the communication menu:

1. Open the configuration menu. Press button 1 in the "Home menu".
2. Press button 3 or 4 until the communication field has a coloured background.
3. Press button 6 to open the "Communication" menu.

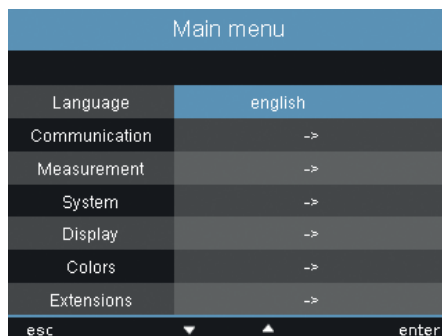

Fig. "Configuration" menu

11. 2. 1 Ethernet (TCP/IP)

Select the mode for address allocation and, if necessary, the IP address, subnet mask and the gateway in this section. The latter is allocated automatically in the BOOTP and DHCP allocation modes.

The device has three types of address allocation:

- **Off** - You define the IP address, subnet mask and gateway, and set them directly on the device. Select this mode for straightforward networks without DHCP servers.
- **BOOTP** - BootP enables a device to be integrated into an existing network fully automatically. However, BootP is an older protocol and does not provide the scope of functions provided by DHCP.
- **DHCP** - When started, the device automatically obtains the IP address, the subnet mask and the gateway from a DHCP server. DHCP is factory-set.

Proceed as follows to adjust the IP address, subnet mask and gateway:

1. Press button 3 or 4 until the relevant field has a coloured background.
2. Press button 6 to activate the input.
 - The font changes to red and a cursor is displayed.
3. Now press button 3 or 4 to select the required digit.
4. Use button 5 to move to the next digit.
5. Repeat steps 3 and 4 until you have completed the required input.
6. Press button 6 to confirm your input.

11. 2. 2 Field bus

If you connect the device via the RS-485 interface, configure the following settings in this section:

- **Modbus protocol** - Here, you can select whether the device works as a Modbus slave, Modbus master/gateway or Profibus DP V0 (optional) within the bus structure.
- **Device address** - Here, you can select a device address that is used to address the device in the bus. This address must be between 0 and 255, and be unique in the tree structure.
- **Baud rate** - Select the same baud rate for all devices in a bus structure. Possible settings are 9600, 19200, 38400, 57600, 115200, 921600 kbps. The factory default setting is 115200 kbps.

Proceed as follows to make the adjustments:

1. Press button 3 or 4 until the relevant field has a coloured background.
2. Press button 6 (enter) to call the selection options.
3. Press button 3 or 4 to select the required value.
4. Press button 6 to confirm your selection.



CAUTION!

Damage to property due to incorrect network settings

Incorrect network settings can cause faults in the IT network.

Obtain information from your network administrator about the correct settings for your device.

11.3 Measurement

You can configure the following in the measurement menu:

- The measuring transducer for current and voltage measurement
- Recording transients
- Recording events
- The relevant voltage
- The mains frequency
- The flicker settings
- The temperature sensor

The device has:

- 4 measurement channels for current measurement (I1 - I4)
- 4 measurement channels for voltage measurement (V1 - V4 against Vref).

Measured voltage and measured current for measurement channels 1-4 must derive from the same network.

Baseline measurement

The baseline measurement uses the measurement channels 1-3. Use measurement channels 1-3 in three-phase systems.

Supporting measurement

The supporting measurement only uses measurement channel 4. Use measurement channel 4 when measuring in single-phase systems or in three-phase systems with symmetrical loads.

The frequency setting and the setting for the relevant voltage are pulled automatically from the baseline measurement settings.

Measurement	
Transformer	->
Transients	->
Events	->
Voltage mode	L-N
Rated Freq.	50 Hz (fixed frequency)
Flicker	230V/50Hz
Temperatur	PT100
esc	enter

Fig. "Measurements" menu

11.3.1 Measuring transducer

You can make the following adjustments for baseline and supporting measurements here:

- Current transformer
- Voltage transformer
- Rated current
- Transfer AUX / Main
- Connection

As well as settings for transformation ratios and monitoring for the residual current transformer

Current transformer

You can assign current transformer ratios to the baseline measurement and the supporting measurement.

Select the 5/5 A setting when measuring currents directly.

Setting range:

Primary	1 to 1000000
Secondary	1 to 5

Factory default setting:

Primary	5
Secondary	5

Rated current

The rated current defines the reference value for the following measurements:

- Overcurrent
- Current transients
- K factor
- Automatic scaling of graphics

Setting range: 0 to 1000000 A

Transformer MAIN		
	primary	secondary
Current Transf.	5A	5A
Voltage Transf.	400V	400V
Rated Current		150A
Rated Voltage		230V
Apply to AUX		no
Connection		4w2l
esc ▼ ▲ enter		

Fig. Configuring current transformer ratios

Voltage transformer

You can assign voltage transformer ratios to the baseline measurement and the supporting measurement.
 Select the 400/400 V setting when measuring without a voltage transformer.

Setting range:

Primary 1 to 1000000
 Secondary 1 to 999

Factory default setting:

Primary 400
 Secondary 400

Transformer MAIN		
	primary	secondary
Current Transf.	5A	5A
Voltage Transf.	400V	400V
Rated Current		150A
Rated Voltage		230V
Apply to AUX		no
Connection		4w2l

Fig. Measuring transducer for baseline measurement

Rated voltage

The rated voltage corresponds to the "arranged input voltage U_{din}" according to EN 61000-4-30.

The rated voltage defines the reference point for:

- upward deviation (EN 61000-4-30)
- downward deviation (EN 61000-4-30)
- transients
- events
- automatic scaling of graphics

Setting range: 0 to 1000000 V

Factory default setting: 230 V

Transfer AUX / MAIN

These settings can be adjusted separately for the baseline measurement and supporting measurement.

You can use the "Transfer AUX / Main" menu item to transfer the settings from the supporting measurement or the baseline measurement, in order to prevent having to enter everything again.

- **No** - The settings from the supporting and baseline measurement are not transferred.
- **Yes** - The settings from the supporting measurement and baseline measurement are transferred.

Connection

You can select between different connection schemes (see "7. 7 Connection variants") for voltage and current measurement using the "Connection" selection.

Factory default setting: 4w3m

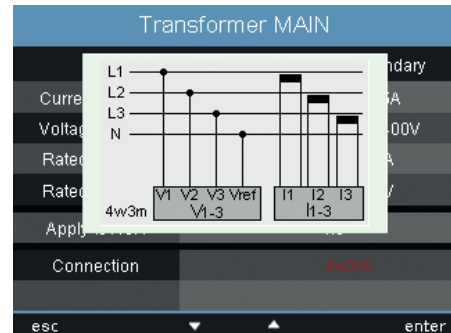

Fig. Example for measurement in a three-phase 4-conductor network with asymmetric loading

Residual current transformer

When using residual current inputs I5 and I6, the corresponding transformer ratios of the used residual current transformer must be set.

Setting range:

Primary	1 to 1000000
Secondary	1

Factory default setting:

Primary	127
Secondary	1

Transformer AUX		
	primary	secondary
Current Transf.	127A	1.000A
break detection		yes
Current Transf.	127A	1.000A
break detection		yes
esc		enter

Fig. Residual current transformer menu

You can also use this menu to adjust failure monitoring for the corresponding residual current inputs:

- **Activated** - Switches on failure monitoring for residual current monitoring.
- **Deactivated** - Switches off failure monitoring for residual current monitoring.

Transformer AUX		
	primary	secondary
Current Transf.	127A	1.000A
break detection		yes
Current Transf.	127A	1.000A
break detection		yes
esc		enter

Fig. Failure monitoring

11.3.2 Transients

Allocations MAIN		
Transients		
Mode (abs)	automatically	
Peak U	0%	(0.0V)
Mode (delta)	automatically	
Trms U	0%	(0.0V)
Modus (abs I)	off	
Peak I	0%	(0.0A)
Modus (envelop)	automatically	
Envelop U	0%	(0.0V)
Apply to AUX	no	
esc		enter

The device:

- monitors the measurement inputs for transients.
- detects transients that are longer than 39 μ s.
- can detect transients according to two different criteria.

If a transient has been detected:

- the wave form is saved to a transient record.
- the threshold value increases by 20 V for the next 10 minutes, both in automatic and in manual mode.
- it will be recorded with 512 points for a period of 60 seconds per additional transient.

You can use the GridVis® event browser to display recorded transients.

The following modes are available for recording the transients:

- **absolute**
- **delta**
- **envelop**

Mode (absolute)

If a sample value exceeds the set threshold value, a transient is detected:

- **Off** - Transient monitoring has been switched off
- **Automatic** - Factory default setting. The threshold value is calculated automatically and is 110% of the current 200 ms effective value.
- **Manual** - Transient monitoring uses the configurable threshold values under "Peak".

Mode (delta)

If the difference between two neighbouring sample points exceeds the set threshold value, a transient is detected:

- **Off** - Transient monitoring has been switched off.
- **Automatic** - Factory default setting. The threshold value is calculated automatically and is 0.2175 times the current 200 ms effective value.
- **Manual** - Transient monitoring uses the configurable threshold values under "Trns U".

Mode (envelop)

If a sample value exceeds the envelop range, a transient is detected:

- **Off** - Transient monitoring has been switched off
- **Automatic** - Factory default setting. The envelop is automatically calculated and is $\pm 5\%$ of the rated voltage.
- **Manual** - Transient monitoring uses the configurable envelop.

Transfer AUX / MAIN

These settings can be adjusted separately for the baseline measurement and supporting measurement.

You can use the "Transfer AUX / Main" menu item to transfer the settings from the supporting measurement or the baseline measurement, in order to prevent having to enter everything again.

11.3.3 Events

Events are threshold value violations of set threshold values for current and voltage.

Here, threshold values are compared with the half wave effective values for current and voltage from the measurement channels. The event record contains the following:

- a mean value
- a min. and max. value
- a start and end time.

An event describes faults due to:

- overvoltage/undervoltage
- voltage loss
- overcurrent
- overfrequency/underfrequency
- rapid frequency changes

Monitoring of the threshold values can be switched off (Off/Manual).

You can set threshold values and hysteresis as a percentage of the rated value for:

- overvoltage and undervoltage,
- voltage interruption
- overcurrent.

If an event has occurred, the corresponding measured value is recorded with the set pre-run and after-run periods (respectively 0 to 1000 half waves).

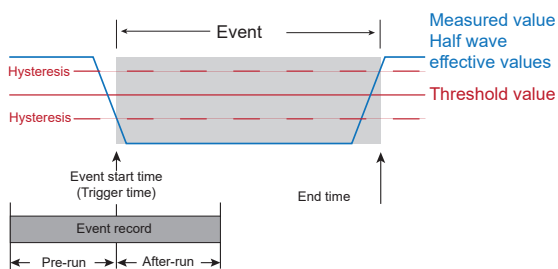

NOTE!

You can use the GridVis® software to set an event record. (see www.janitza.de)



NOTE!

You can only set the pre-run and after-run using the GridVis® software.

Factory default setting: 0

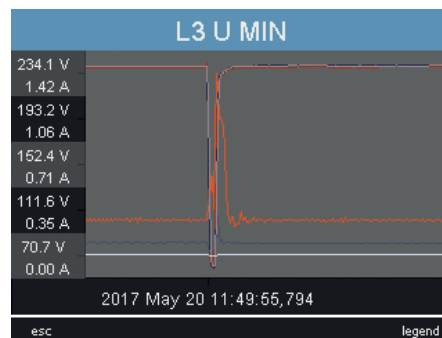

Fig. Illustration of the half wave effective values for an event

Voltage dip

A voltage dip is set in % of the rated voltage.

Overvoltage

The overvoltage is set in % of the rated voltage.

Overcurrent

The rapid increase of current is set in % of the nominal current.

Transfer AUX / Main

These settings can be adjusted separately for the baseline measurement and supporting measurement.

You can use the "Transfer AUX / Main" menu item to transfer the settings from the supporting measurement or the baseline measurement, in order to prevent having to enter everything again.

11.3.4 Relevant voltage

Depending on the application situation, the power quality

- the voltage between the phase conductors (L), i.e. **L-L**
- or the voltage between the phase conductor (L) and the neutral conductor (N), i.e. **L-N** is relevant for the analysis.

You can choose between these two settings in the relevant voltage menu item.

We recommend the "L-N" setting for measuring the power quality in low voltage networks. You should select the "L-L" setting in medium voltage power grids.

11.3.5 Nominal frequency

The device determines the mains frequency from the voltage applied to L1 and uses this for the additional calculations.

Set the nominal frequency for the network manually on the device before starting measurement. The nominal frequency is required as a reference for measurement of the power quality.

Setting range of the nominal frequency:

- 50 Hz (factory default setting)
 - 60 Hz
 - 15 Hz to 440 Hz (automatic)
- Select a nominal frequency of 50 Hz or 60 Hz to measure the power quality in accordance with EN61000 4 30 and EN50160.
 - Set the nominal frequency to "Wide range" for measurements in networks with other nominal frequencies e.g. 16 2/3 Hz or 400 Hz.

Measurement	
Transformer	->
Transients	->
Events	->
Voltage mode	L-N
Rated Freq.	50 Hz (fixed frequency)
Flicker	230V/50Hz
Temperatur	PT100
esc	enter

Fig. Setting the nominal frequency



NOTE!

In order to determine the mains frequency automatically, a voltage L1-N of greater than 10 V_{eff} must be applied to voltage measurement input V1.



NOTE!

Flicker values can only be determined if the relevant voltage L-N is given.

11. 3. 6 Flicker

The device requires the mains base values in order to provide voltage and frequency-independent measurement and calculation of the flicker values (flicker measurement as per DIN EN61000-4-15:2011). These values are to be specified by the user and can be selected from a predefined list:

- 230 V/50 Hz (factory default setting)
- 120 V/50 Hz
- 230 V/60 Hz
- 120 V/60 Hz

Measurement	
Transformer	->
Transients	->
Events	->
Voltage mode	L-N
Rated Freq.	50 Hz (fixed frequency)
Flicker	230V/50Hz
Temperatur	PT100

Fig. Setting the flicker values



NOTE!

Flicker values can only be determined if the relevant voltage L-N is given.

11. 3. 7 Temperature

When using a temperature measurement, select the corresponding sensor type from a predefined list:

- PT100
- PT1000
- KTY83
- KTY84

Measurement	
Transformer	->
Transients	->
Events	->
Voltage mode	L-N
Rated Freq.	50 Hz (fixed frequency)
Flicker	230V/50Hz
Temperatur	PT100

Fig. Setting the sensor type for temperature measurement.

11.4 System

You can call system settings and change them as far as possible here.

System		
1	Version	5.000
2	Serial	42000678
3	MAC	00:0E:6B:09:02:A6
4	Address	195.145.150.168
5	Gateway	195.145.150.161
6	Date/Time	31.07.2017 09:34:19
7	Password	0
8	Re-initialization	->

esc ▼ ▲ enter

Fig. System settings

- 1 Firmware version
- 2 Device serial number
- 3 Fixed MAC address of the device
- 4 Set IP address
- 5 Set gateway address
- 6 Date and time
- 7 Set password
- 8 Reset settings



NOTE!

You can use the GridVis® software to make the settings for time synchronisation, date and time. (see www.janitza.de)

11.4.1 Password

You can use a password to block access to the configuration. The configuration can then only be changed directly on the device by entering the password.

The password consists of a 6-digit code.

Setting range:

- 1-999999 = With password
- 0 = no password

A password (0) is not factory-set.

To change a password that has already been set, you must know the current password.

Note down the changed password.

Proceed as follows to set a password:

1. Open the system menu
2. Use button 3 or 4 to navigate to the password setting.
3. Press button 6 to open the output.
4. Now press button 2 or 5 to enter the required button.
5. Press button 6 again to confirm your input.
 - If you no longer want a password prompt, enter the password "0".



NOTE!

If you no longer remember your password, you can only change it using the GridVis® software. (see www.janitza.de)

11. 4. 2 Reset

You can reset the settings to the factory settings in this area.

Resetting the energy

You can clear all energy meters in the device at the same time. Specific energy meters cannot be selected.

1. Open the reset menu.
2. Use button 3 or 4 to select the "Reset energy" item (highlighted in colour)
3. Press button 6 to activate the input.
 - The font colour changes to red and a cursor is displayed.
4. Change the value by pressing button 4 on "Yes".
5. Press button 6 to confirm your input.
 - The "Carried out" message appears in the line, all energy meters have been cleared.

Deleting min. / max. values

You can clear all min. and max. values in the device at the same time.

For information on how to clear individual min. and max. values, see "10. 6 Deleting values".

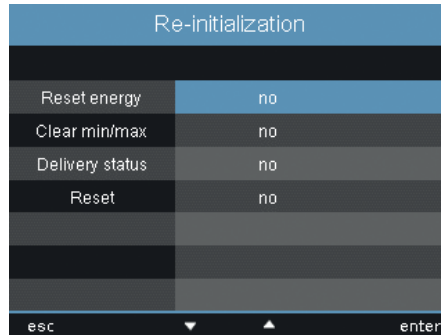

Fig. Deleting min. / max. values

1. Open the reset menu.
2. Use button 3 or 4 to select the "Min./max. values" item (highlighted in colour).
3. Press button 6 to activate the input.
 - The font colour changes to red and a cursor is displayed.
4. Change the value by pressing button 4 on "Yes".
5. Press button 6 to confirm your input.
 - The "Carried out" message appears in the line, all min. and max. values have been cleared.



NOTE!

Before commissioning, clear any content that may be present on the power meters, min./max. values or recordings due to the production process.

Delivery status

You can reset all settings such as the configuration and the recorded data to the factory default setting here. Entered activation codes are not deleted.

1. Open the reset menu.
2. Use button 3 or 4 to select the "Delivery status" item (highlighted in green)
3. Press button 6 to activate the input.
 - The font colour changes to red and a cursor is displayed.
4. Change the value by pressing button 4 on "Yes".
5. Press button 6 to confirm your input.
 - The "Carried out" message appears in the line, the delivery status is restored.

Re-initialisation

Proceed as follows to re-initialise the device manually:

1. Open the reset menu.
2. Use button 3 or 4 to select the "Re-initialise" item (highlighted in green)
3. Press button 6 to activate the input.
 - The font colour changes to red and a cursor is displayed.
4. Change the value by pressing button 4 on "Yes".
5. Press button 6 to confirm your input.
 - The device re-initialises within approx. 10 seconds.

11.5 Display

You can adjust your device's display settings here.

Brightness

You can adjust your device's display brightness here. Proceed as described in the template in the previous chapter.

Setting range: 0 to 100%

Factory default setting: 70%

- 0% = dark
- 100% = very bright

**NOTE!**

The service life of the backlight is extended if the brightness of the backlight is lower.

Standby

Here, you can set the time after which the display brightness switches to the set standby brightness.

Setting range: 60 to 9999 sec.

Factory default setting: 900 sec.

Brightness (standby)

Here, you can set the display brightness that the system switches to after the standby time has elapsed. The standby time is restarted using buttons 1-6.

Setting range: 0 to 60%

Factory default setting: 40%

Screen Saver

You can activate or deactivate the screen saver here.



NOTE!

If the same screen is shown on the display for an extended period, this can cause damage to the display. Using the screen saver prevents this and therefore extends the display's service life.

Setting range: Yes, no
Factory default setting: Yes

Display

Here, you can define the speed at which the new measured values appear in the measured value indications. The following speeds are available:

- fast
- slow (200ms)
- slow (1 sec.)

Factory default setting: Fast

Rotate

You can activate or deactivate the automatic changeover between the different measured value indications here.

Setting range: Yes, no
Factory default setting: No

Rotation interval

Here, you can set the time after which the screen automatically switches to the next measured value indication.

Setting range: 0 to 255 seconds
Factory default setting: 0 seconds

11.6 Colours

You can select the colours for displaying the current and voltage in the graphic representations here.

1. Press button 3 or 4 until the colour field has a coloured background
2. Press button 6 to open the colours menu
3. Press button 3 or 4 to select the required colour field.
4. Press button 6 to confirm your selection
5. Press button 3 or 4 to select the required colour.
6. Press button 6 to confirm your selection.

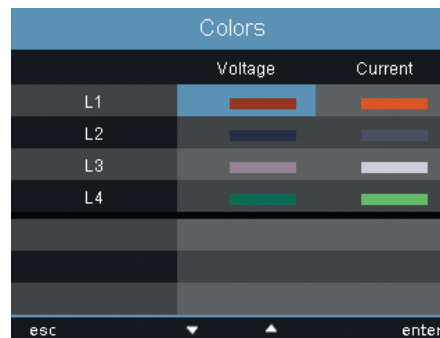

Fig. Menu setting for colours

11.7 Extensions

Here, you can:

- activate functions that are subject to charge.
- call the status of the Jasic programs.

Activation

The device contains the following functions that are subject to charge, which you can activate subsequently:

- BACnet

You receive the activation codes from the manufacturer. The manufacturer requires the serial number of the device and the name of the function to be activated.

To activate the function, enter the 6-digit activation code in the corresponding line.

Make sure that the activation code is only valid for one device.

Jasic status

Up to 7 customer-specific Jasic programs (1-7) and a recording can run in the device.

The Jasic programs can have the following statuses:

- stopped
- running

Extensions	
	Jasic-state
Jasic-state 1	running
Jasic-state 2	running
Jasic-state 3	running
Jasic-state 4	running
Jasic-state 5	running
Jasic-state 6	running
Jasic-state 7	stopped
Records	running
esc	

Fig. Menu setting for Jasic status

Extensions	
Activation	->
Jasic-state	->
Customkey	0
esc	enter

Fig. Menu setting for extensions

NOTE!
 You can only change the status of the Jasic programs using the software.

12. Commissioning

This section provides you with all the information you require to commission your device for the first time

12.1 Supply voltage

Proceed as follows when setting up the supply voltage:

1. Connect the supply voltage to the rear of the device using a terminal.
2. After connecting the supply voltage, the first measured value indication "Home" appears on the display after around 15 seconds.
3. If no display appears, check whether the supply voltage is within the rated voltage range.



CAUTION!

Damage to property due to not observing the connection conditions

Failure to observe the connection conditions can damage or destroy your device.

Therefore, note the following:

- **Adhere to the specifications for voltage and frequency on the rating plate.**
- **Do not use the device to measure DC voltage.**



NOTE!

Before commissioning, clear any content that may be present on the power meters, min./max. values or recordings due to the production process.

12.2 Measured voltage

Voltage measurements in networks with rated voltages of over 500 VAC to earth must be connected via voltage transformers.

Proceed as follows when connecting measured voltage:

1. Connect the measured voltage to the rear of the device using a terminal.
2. After connecting the measured voltage, the measured values displayed by the device for the L-N and L-L voltages must correspond to those on the measurement input.
3. Pay attention to any voltage transformer factors that are set.



WARNING!

Risk of injury due to electric voltage!

If the device is subjected to surge voltages higher than the permissible overvoltage category, safety-relevant insulations in the device can be damaged, which means that the product's safety can no longer be guaranteed.

Only use the device in environments in which the permissible overvoltage category is not exceeded.

12.3 Frequency measurement

To measure, the device requires mains frequency that can either be specified by the user or determined automatically by the device.

- In order to determine the frequency automatically, at least a voltage ($V-V_{ref}$) of greater than 10 V_{eff} must be applied to at least one of the voltage measurement inputs.
- The mains frequency must be in the range from 15 Hz to 440 Hz.
- If there is no sufficiently high measured voltage available, the device cannot determine the mains frequency and therefore cannot perform any measurements.

12.4 Phase sequence

Check the direction of the rotating field voltage in the measured value indication of the device.

A “right-hand” rotation field usually exists.

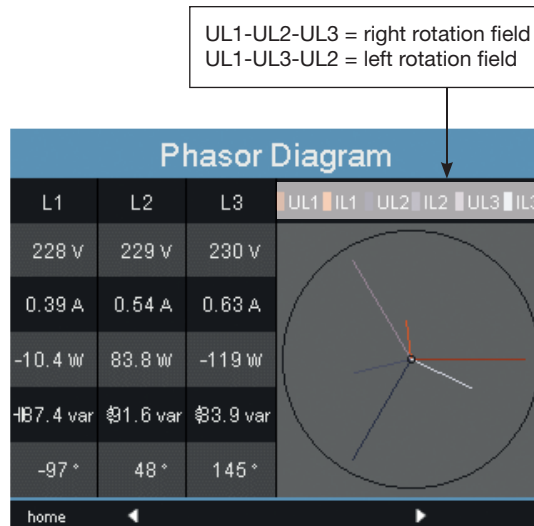

Fig. Indication of the phase sequence according to the direction of the rotating field.

12.5 Measured current

The device:

- is intended for connecting current transformers with secondary currents of ≈ 1 A and ≈ 5 A.
- does not measure DC.
- has current measurement inputs that can be loaded with 120 A for 1 second.

The factory default for the current transformer ratio is 5/5 A and must be adapted to the current transformer employed if necessary.

Proceed as follows when connecting the measured voltage:

1. short circuit all current transformer outputs except for one.
2. connect the measured voltage via the terminals on the back of the device and affix it sufficiently with two screws.
3. compare the current displayed on the device with the current input.
 - the currents must match based on the current transformer conversion ratio.
 - the device must display approx. zero amperes in the short circuited current measurement inputs.

Phase shift angle sign prefix (U/I):

- positive (+) for capacitive load
- negative (-) for inductive load

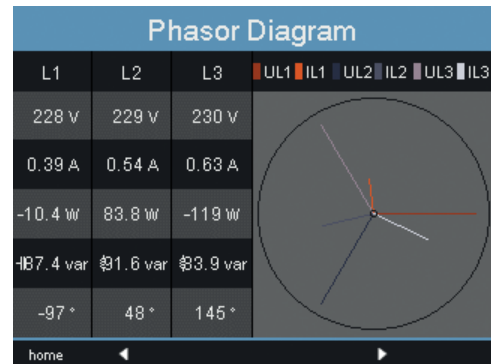
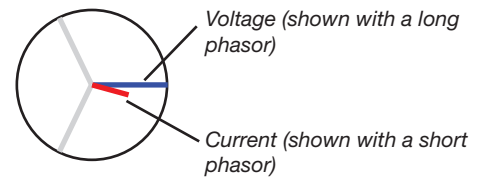

Fig. Phasor diagram



NOTE!

Voltages and currents that are outside the permissible metering range can damage the device.

12.5.1 Phasor diagram examples

The following are two examples for an indication of measured current and measured voltage in the phasor diagram:

Example 1

Predominantly ohmic load.

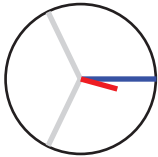

Voltage and current only have a minor deviation in the phase length.

- The current measurement input is assigned to the correct voltage measurement input

Example 2

Predominantly ohmic load.

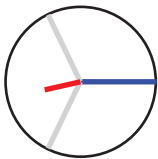

Voltage and current have a deviation of about 180° in the phase position.

- The measurement input is assigned to the correct voltage measurement input.
- In the current measurement considered here, the k and l connections are reversed or there is a return feed in the mains power supply.

12.6 Residual current

Only connect residual current transformers with a rated current of 30 mA to inputs I5 and I6!

Both residual current inputs can measure AC currents, pulsing direct currents and DC currents.

Bearing in mind the current transformer ratio, the residual current displayed by the device must correspond to the current input.

The current transformer ratio is factory-set to 5/5 A and must be adapted to the residual current transformer used if necessary.

NOTE!

It is not necessary to configure a connection schematic for measurement inputs I5 and I6!

NOTE!

The device requires the mains frequency to measure the residual currents. Establish a measured voltage for this or set a fixed frequency.

12.7 Failure monitoring (RCM)

The device enables continuous monitoring of the connection to the residual current transformer on inputs I5 and I6.

You can activate failure monitoring via:

- the relevant menu item as described in section “11. 3. 1 Measuring transducer”.
- or by setting address 13793 for residual current measurement input I5 and 13795 for I6.

If there is an interruption in the connection to the current transformer, this state is recorded in certain registers or indicated in the GridVis® software.

Modbus addr.	Value / Function
13793 (I5) 13795 (I6)	Failure monitoring for I5 / I6 0 = Deactivate monitoring 1 = Activate monitoring

Modbus addr.	Value / Function
13805 (I5) 13806 (I6)	0 = Connection of the residual current transformer to I5 and I6 error-free 1 = Error in the current transformer connection to I5 and I6

12.7.1 Alarm status

Using bit-by-bit coding inside the alarm register (addr. 13921 for I5, 13922 for I6), it is possible to read out different alarm statuses:

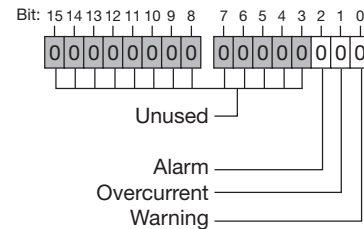

Fig. Alarm register

Example:

Overcurrent was measured. The alarm bit is also set and must be acknowledged!

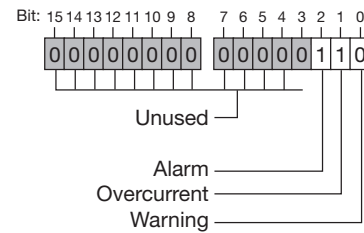

Fig. Example of alarm register if overcurrent is measured.

Warning:	The residual current has exceeded the set warning limit value
Overcurrent:	The measurement range has been exceeded
Alarm:	The alarm bit is set if there is a warning or overcurrent. The alarm bit must be reset or acknowledged manually.

12.8 Measurement range exceeded

If the measurement range is exceeded, it is displayed as long as this persists and cannot be acknowledged. The measurement range is exceeded if at least one of the four voltage or current measurement inputs lies outside their specified measuring range.

Threshold values for exceeding the measurement range (200 ms effective values):

I	=	7 Amps
UL-N	=	600 Vrms

Error - Overload		
	Voltage	Current
L1	225.5 V	0.0 A
L2	EEEE	0.0 A
L3	225.4 V	0.0 A
L4	0.5 V	EEEE

Fig. Indication of values exceeding the measurement range in voltage circuit L2 and in current path I4

12.9 Checking the power measurement

- Short circuit all current transformer outputs except for one.
- Check the powers displayed.
 - The device may only display one power output in the phase with a non-short-circuited current transformer input.
 - If this is not the case, check the connection of the measured voltage and the measuring-circuit current.

If the active power amount is correct but the sign of the power output is negative, this could have two possible causes:

- S1(k) and S2(l) are reversed at the current transformer.
- Active energy is being supplied back into the network.

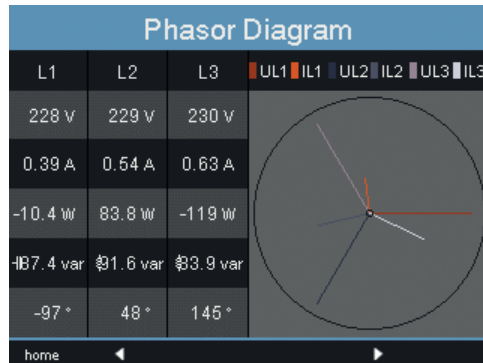

Fig. In the Phasor diagram, the voltages are displayed with long phasors and the currents with short phasors.

12.10 Checking the communication

The device counts all received (RX), all transmitted (TX) and all faulty data packages.

Ideally, the number of errors displayed in the error column is zero.

You can reset the counter for the data packages to 0 by pressing button 6. The start time for the new counting process is reset automatically.

Communication State			
	RX	TX	Error
Ethernet	7121.0 k	8416.4 k	461834
RS485	0	1	1
NTP	37	0	0
DHCP	35	35	0
DNS	336	335	1
EMail	-	0	0
Start Time	13-07-2017 19:22:49		

Fig. Communication status

12. 11 Communication in the bus system

12. 11. 1 RS485

The MODBUS RTU protocol with CRC check on the RS485 interface can be used to access the data from the parameter and the measured value lists (see “11. 2. 2 Field bus”).

Modbus functions (master)

- 01 Read coil status
- 02 Read input status
- 03 Read holding registers
- 04 Read input registers
- 05 Force single coil
- 06 Preset single register
- 15 (0F Hex) Force multiple coils
- 16 (10Hex) Preset multiple registers
- 23 (17Hex) Read/write 4X registers

Modbus functions (slave)

- 03 Read holding registers
- 04 Read input registers
- 06 Preset single register
- 16 (10Hex) Preset multiple registers
- 23 (17Hex) Read/write 4X registers

The sequence of bytes is high before low byte (Motorola format).

Transmission parameters

- Data bits: 8
- Parity: None
- Stop bits (UMG 512-PRO): 2
- External stop bits: 1 or 2

Number formats

- short 16 bit (-2¹⁵ to 2¹⁵ -1)
- float 32 bit (IEEE 754)



NOTE!

Broadcast (address 0) is not supported by the device.



NOTE!

The message length must not exceed 256 bytes.

Example: Reading the L1-N voltage

The L1-N voltage is saved in the measured value list at address 19000. The L1-N voltage is available in FLOAT format.

The device address is 01 in this example.

The Query Message appears as follows:

Designation	Hex	Comment
Device address	01	Address=1
Function	03	“Read Holding Reg”
Start address Hi	4A	19000dez = 4A38hex
Start address Lo	38	
Ind. Hi values	00	2dez = 0002hex
Ind. Lo values	02	
Error check (CRC)	-	

The "Response" of the device can appear as follows:

Designation	Hex	Comment
Device address	01	Address=1
Function	03	
Byte meter	06	
Data	00	00hex=00dez
Data	E6	E6hex=230dez
Error check (CRC)	-	

The L1-N voltage read by address 19000 is 230 V.

12. 11. 2 Profibus

Profibus profiles

A Profibus profile contains the data to be exchanged between a UMG and a PLC. Four Profibus profiles are preconfigured at the factory.

You can use the Profibus profile to:

- retrieve measured values from the UMG
- set the digital outputs in the UMG
- query the status of the digital inputs in the UMG.

Each Profibus profile can hold a maximum of 127 bytes of data. If more data has to be transferred, simply create additional Profibus profiles.

Each Profibus profile has a profile number that is sent by the PLC to the UMG.

You can use GridVis® to edit 16 Profibus profiles (profile numbers 0 to 15) directly. Additional Profibus profiles (profile numbers 16 to 255) can be created using Jasic programs.

Factory pre-configured Profibus profiles cannot be subsequently changed.

Device master file

The device master file, abbreviated as the GSD file, describes the Profibus characteristics of the UMG. The GSD file is required by the configuration program of the PLC.

The device master file for your device has the file name "JAN0EDC.GSD" and is available on the Janitza homepage.

Variable definition

All system variables and global variables¹⁾ can be individually scaled and converted into one of the following formats:

- 8, 16, 32 bit integer with and without sign.
- 32 or 64 bit float format.
- Big endian = High byte before low byte.
- Little endian = Low byte before high byte.

¹⁾ Global variables are defined by the user in Jasic and are available to each interface in the device.

Example: Using Profibus to retrieve measured values

You must use the GridVis® software to define at least one Profibus profile and transfer this to the device.

A Jasic program is not required.

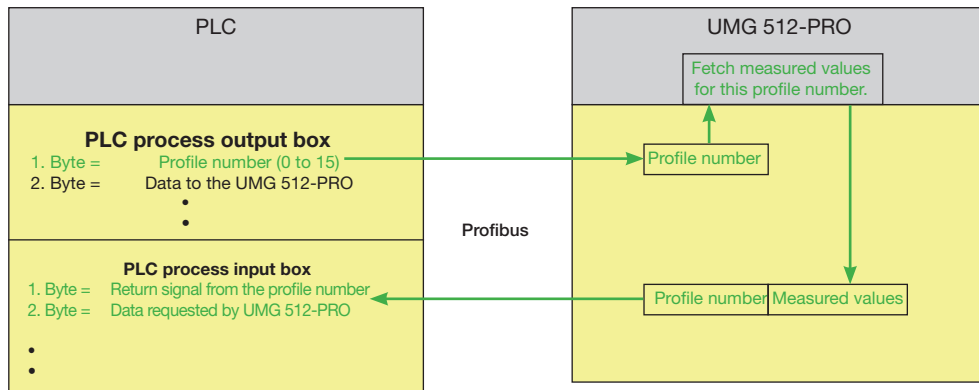

Fig. Block diagram for data exchange between PLC and UMG 512-PRO.

Factory pre-configured profiles

This section provides you with a tabular overview of the pre-configured Profibus profiles

Profibus profile number 0

	Byte index	Value type	Value format	Scaling
1	1	Voltage L1-N	Float	1
2	5	Voltage L2-N	Float	1
3	9	Voltage L3-N	Float	1
4	13	Voltage L4-N	Float	1
5	17	Voltage L2-L1	Float	1
6	21	Voltage L3-L2	Float	1
7	25	Voltage L1-L3	Float	1
8	29	Current L1	Float	1
9	33	Current L2	Float	1
10	37	Current L3	Float	1
11	41	Current L4	Float	1
12	45	Active power L1	Float	1
13	49	Active power L2	Float	1
14	53	Active power L3	Float	1
15	57	Active power L4	Float	1
16	61	Cos phi (math.) L1	Float	1
17	65	Cos phi (math.) L2	Float	1
18	69	Cos phi (math.) L3	Float	1
19	73	Cos phi (math.) L4	Float	1
20	77	Frequency	Float	1
21	81	Total active power L1-L4	Float	1
22	85	Total reactive power L1-L4	Float	1
23	89	Total apparent power L1-L4	Float	1
24	93	Total cos phi (math.) L1-L4	Float	1
25	97	Total effective current L1-L4	Float	1
26	101	Total active energy L1-L4	Float	1
27	105	Ind. Total reactive energy L1-L4	Float	1
28	109	THD voltage L1	Float	1
29	113	THD voltage L2	Float	1
30	117	THD voltage L3	Float	1

Profibus profile number 1

	Byte index	Value type	Value format	Scaling
1	1	Voltage L1-N	Float	1
2	5	Voltage L2-N	Float	1
3	9	Voltage L3-N	Float	1
4	13	Voltage L2-L1	Float	1
5	17	Voltage L3-L2	Float	1
6	21	Voltage L1-L3	Float	1
7	25	Current L1	Float	1
8	29	Current L2	Float	1
9	33	Current L3	Float	1
10	37	Active power L1	Float	1
11	41	Active power L2	Float	1
12	45	Active power L3	Float	1
13	49	Cos phi (math.) L1	Float	1
14	53	Cos phi (math.) L2	Float	1
15	57	Cos phi (math.) L3	Float	1
16	61	Frequency	Float	1
17	65	Total active power L1-L3	Float	1
18	69	Total reactive power L1-L3	Float	1
19	73	Total apparent power L1-L3	Float	1
20	77	Total cos phi (math.) L1-L3	Float	1
21	81	Total effective current L1-L3	Float	1
22	85	Total active energy L1-L3	Float	1
23	89	Ind. Total reactive energy L1-L3	Float	1
24	93	THD voltage L1	Float	1
25	97	THD voltage L2	Float	1
26	101	THD voltage L3	Float	1
27	105	THD current L1	Float	1
28	109	THD current L2	Float	1
29	113	THD current L3	Float	1

Profibus profile number 2

Byte index	Value type	Value format	Scaling	
1	1	Total active energy L1-L3	Float	1
2	5	Rel. Total active energy L1-L3	Float	1
3	9	Deliv. Total active energy L1-L3	Float	1
4	13	Total reactive energy L1-L3	Float	1
5	17	Ind. Total reactive energy L1-L3	Float	1
6	21	Total cap. reactive energy L1-L3	Float	1
7	25	Total apparent energy L1-L3	Float	1
8	29	Active energy L1	Float	1
9	33	Active energy L2	Float	1
10	37	Active energy L3	Float	1
11	41	Inductive reactive energy L1	Float	1
12	45	Inductive reactive energy L2	Float	1
13	49	Inductive reactive energy L3	Float	1

Profibus profile number 3

Byte index	Value type	Value format	Scaling	
1	1	Active power L1	Float	1
2	5	Active power L2	Float	1
3	9	Active power L3	Float	1
4	13	Total active power L1-L3	Float	1
5	17	Current L1	Float	1
6	21	Current L2	Float	1
7	25	Current L3	Float	1
8	29	Total current L1-L3	Float	1
9	33	Total active energy L1-L3	Float	1
10	37	Cos phi (math.) L1	Float	1
11	41	Cos phi (math.) L2	Float	1
12	45	Cos phi (math.) L3	Float	1
13	49	Total cos phi (math.) L1-L3	Float	1
14	53	Reactive power L1	Float	1
15	57	Reactive power L2	Float	1
16	61	Reactive power L3	Float	1
17	65	Total reactive power L1-L3	Float	1
18	69	Apparent power L1	Float	1
19	73	Apparent power L2	Float	1
20	77	Apparent power L3	Float	1
21	81	Total apparent power L1-L3	Float	1

12. 12 Digital inputs/outputs

Your device has two digital outputs and two digital inputs.

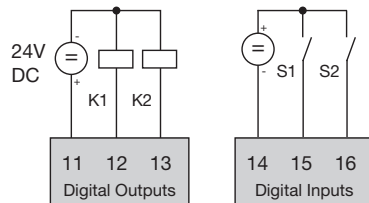

Fig.: Digital outputs and inputs

The inputs and outputs can be configured using the GridVis® software supplied as standard.

12. 12. 1 Digital inputs

You can use the digital inputs to send information from other devices that have a digital output to your device directly.

You can use the configuration window in GridVis® to define the input range for both digital inputs:

- The value type that the incoming signal has.
- The scaling factor that is to be used for the value.

12. 12. 2 Pulse output

The digital outputs can be used for the output of pulses for the computation of power consumption. For this purpose, a pulse of defined length is applied on the output after reaching a certain, adjustable amount of power.

You must make various adjustments in the configuration menu using the GridVis® software to use a digital output as a pulse output:

- pulse width
- digital output that is to be configured,
- output type (event notification or S0 output)
- the measured value to be transferred
- pulse value

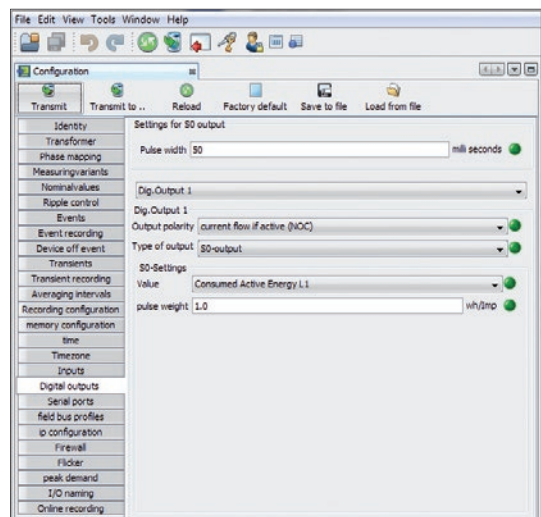

Fig. Configuring the UMG 512-PRO digital outputs via GridVis®.

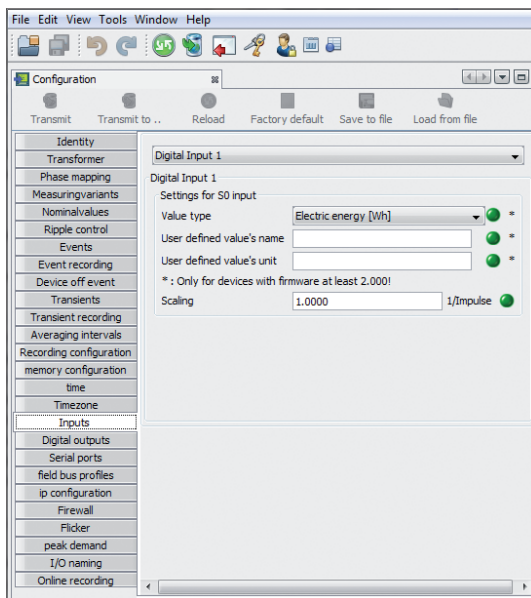

Fig. Configuring the UMG 512-PRO inputs via GridVis®.

Pulse length

The pulse length applies to both pulse outputs and is set using the GridVis® software.

The typical pulse length for S0 pulses is 30 ms.

Pulse interval

The pulse interval is at least as large as the selected pulse length.

The pulse interval depends on the measured power, for example, and can take hours or days.

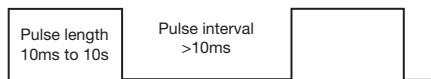

Fig. Schematic illustration of a digital pulse

The values in the table are based on the minimum pulse length and the minimum pulse interval for the maximum number of pulses per hour.

Pulse length	Pulse interval	Max. pulse/h
10 ms	10 ms	180 000 pulses/h
30 ms	30 ms	60 000 pulses/h
50 ms	50 ms	36 000 pulses/h
100 ms	100 ms	18 000 pulses/h
500 ms	500 ms	3600 pulses/h
1 s	1 s	1800 pulses/h
10 s	10 s	180 pulses/h

Table Examples of the maximum possible number of pulses per hour



NOTE!

The pulse interval is proportional to the power output within the selected settings.



NOTE!

When programming with GridVis®, you receive a selection of work values which are derived from the power output values. (see www.janitza.de)

Pulse value

The pulse value is used to indicate how much power (Wh or varh) should correspond to a pulse.

The pulse value is determined by the maximum connected load and the maximum number of pulses per hour.

If you specify a pulse value with a:

- positive sign, the pulses will only be emitted when the measured value has a positive sign.
- negative sign, the pulses will only be emitted when the measured value has a negative sign.



NOTE!

Since the active energy meter operates with a backstop, pulses will only be generated when drawing electricity.



NOTE!

Since the reactive energy meter operates with a backstop, pulses will only be generated with inductive load applied.

Determine the pulse value

1. Set the pulse length in accordance with the requirements of the connected pulse receiver. For example, if the pulse length is 30 ms, the device generates a maximum number of 60000 pulses (see "maximum number of pulses" per hour table).
2. Determine the maximum connected load.

Example:

Current transformer = 150/5 A
 Voltage L-N = max. 300 V

Power per phase = 150 A x 300 V
 = 45 kW

Power at 3 phases = 45 kW x 3
 Max. connected load = 135 kW

3. Calculate the pulse value:

$$\text{Pulse value} = \frac{\text{max. connected load}}{\text{max. number of pulses/h}} \quad [\text{Pulse/Wh}]$$

Pulse value = 135 kW / 60000 Imp/h
 Pulse value = 0.00225 pulses/kWh
 Pulse value = 2.25 pulses/Wh



CAUTION! Measurement errors when using as a pulse output

When using the digital outputs as pulse outputs, measurement errors may arise due to the residual ripple.
Therefore, use a mains adapter for the supply voltage for the digital inputs and outputs, which has a residual ripple of less than 5% of the supply voltage.

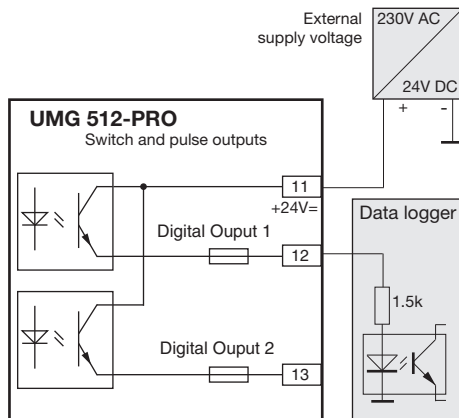

Fig.: Connection example for the circuit as pulse output.

13. Device homepage

Your measurement device has an integrated web server, which has a separate homepage. You can use this device home page to access your measurement device from any end device via a standard web browser. You can access the homepage for your device by entering the device's PI address in a web browser on your end device. Section "11. 2. 1 Ethernet (TCP/IP)" explains how to connect the device to the internet.

You can do the following here without first installing any software:

- call historical and current measured values.
- call the power quality status in an easy to understand illustration.
- control your device remotely.
- access installed apps.

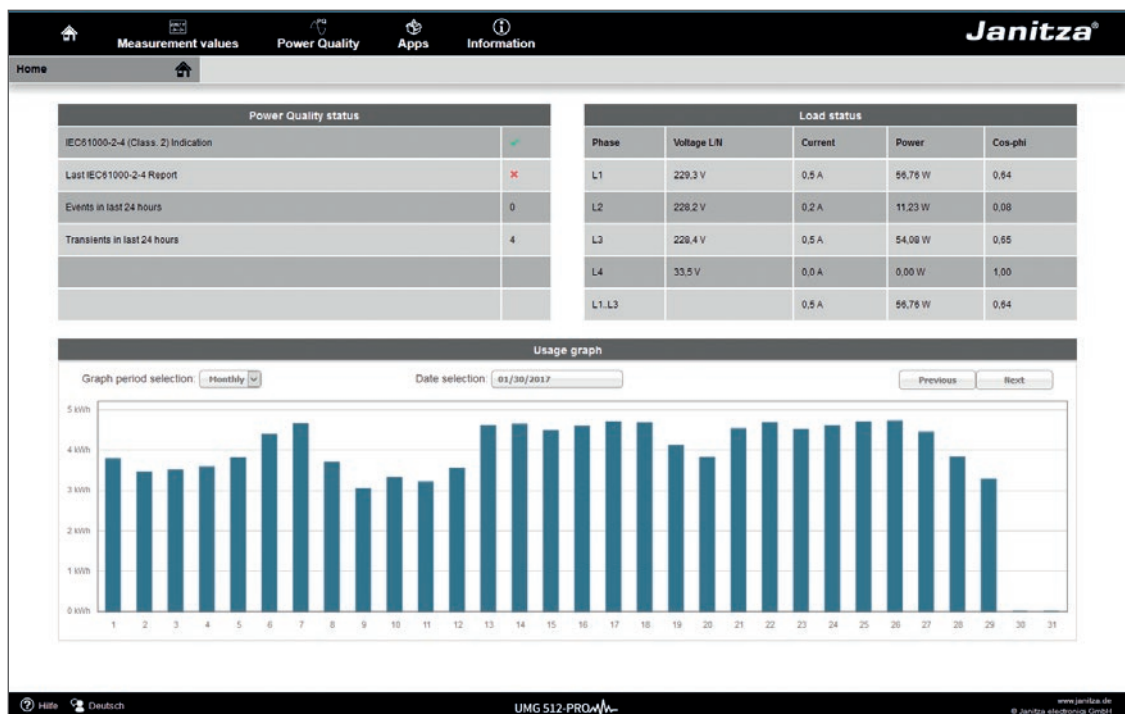

Fig. Device homepage overview

13.1 Measured values

You can use the “Measured values” menu item to call simple and detailed views of the measured values, and to display individual measured values. The following menu items are available:

- short overview
- detailed measured values
- diagrams
- RCM - residual current monitoring
- events

13.1.1 Short overview

The short overview provides you with the most important measured values for each phase, such as the current voltage values, power values and current strength.

Quickview												
Phase	U in V (L/L)	U in V (L/N)	Phase	kW	kWh	kvar	kvarh	Phase	I in A	cos-phi	THD-U	THD-I
L1/L2 L1/N	399.45	229.87	L1	0.02	35	0.00	-18	L1	0.11	0.97	2.25	63.55
L2/L3 L2/N	401.01	231.56	L2	0.01	29	0.00	-12	L2	0.04	0.89	1.76	27.04
L3/L1 L3/N	400.31	231.89	L3	0.01	14	-0.01	-14	L3	0.04	0.77	1.82	54.63
L4/N		39.57	L4	0.00	0	0.00	0	L4	0.00	1.00	36.43	---
			L1..L3	0.04	80	-0.01	-45	L1..L3	0.09	0.93		
			L1..L4	0.04	80	-0.01	-45	L1..L4	0.09	0.93		

Fig. Short overview of measured values

13. 1. 2 Detailed measured values

In the overview, you can call extensive information on the following points:

- Voltage
- Current
- Power
- Harmonic oscillations
- Energy
- Peripheral devices (digital inputs/outputs, temperature measurements)

The screenshot displays the 'Measurement values' section of the Janitza UMG 512-PRO software. The interface includes a top navigation bar with 'Measurement values', 'Power Quality', 'Apps', and 'Information' tabs. Below the navigation bar, there is a header area showing 'Device Name: UMG512 Janitza', 'Time/Date: 10.05 / 31.07.2017 (UTC+2)', and 'Frequency (L/N): 49.99 Hz'. The main content area is divided into several sections:

- Voltage:** A table showing 'Voltage Effective' values for L1, L2, L3, L4, L1-L2, L2-L3, and L3-L1. Each row includes 'Actual value', 'Average value', 'Minimum value', and 'Maximum value'.
- Three-phase values:** A table showing 'Urbalance Voltage' with 'Actual value', 'Average value', 'Minimum value', and 'Maximum value'.
- Frequency:** A table showing 'Frequency' with 'Actual value', 'Average value', 'Minimum value', and 'Maximum value'.
- Current, Power, Harmonics, Flicker:** A series of horizontal bars representing these metrics, each with a right-pointing arrow.

The bottom of the interface shows a footer with 'Help', 'English', and 'UMG 512-PRO'.

Fig. Detailed overview of measured values

13. 1. 3 Diagrams

You can use the “Diagrams” item to access the measured values monitor. The measured values monitor is a configurable display of current and historical measured values with automatic scaling. In order to display a graphic of the measured values, drag the required values from the list on the left edge of the screen into the field in the middle of the screen.

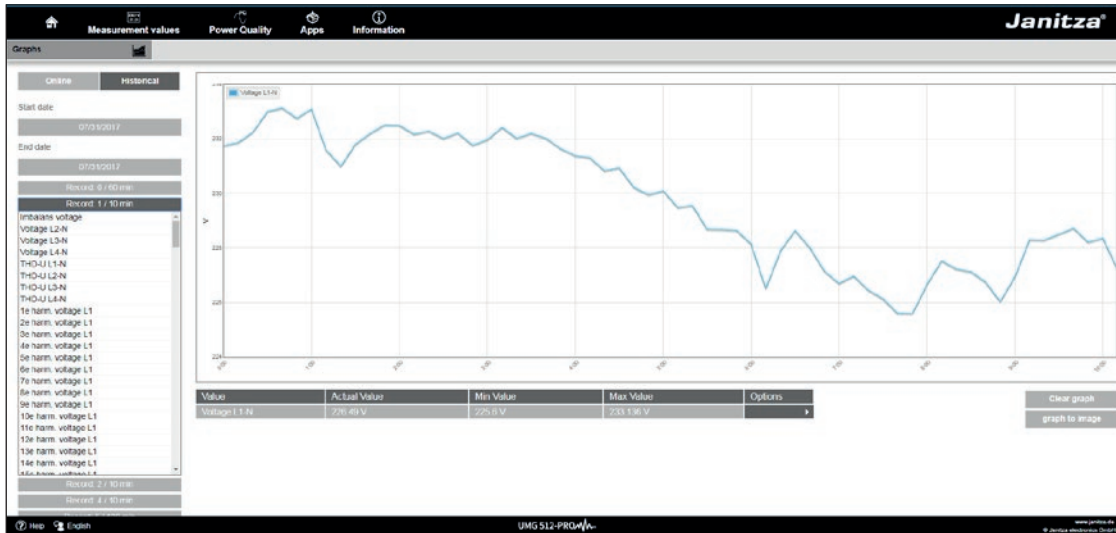

Fig. Device homepage event records

13. 1. 4 RCM - residual current monitoring

The “RCM” item shows you the current values and absolute threshold values for the RCM channels. For more information on residual current monitoring, see chapter 7. 8 on page 25.

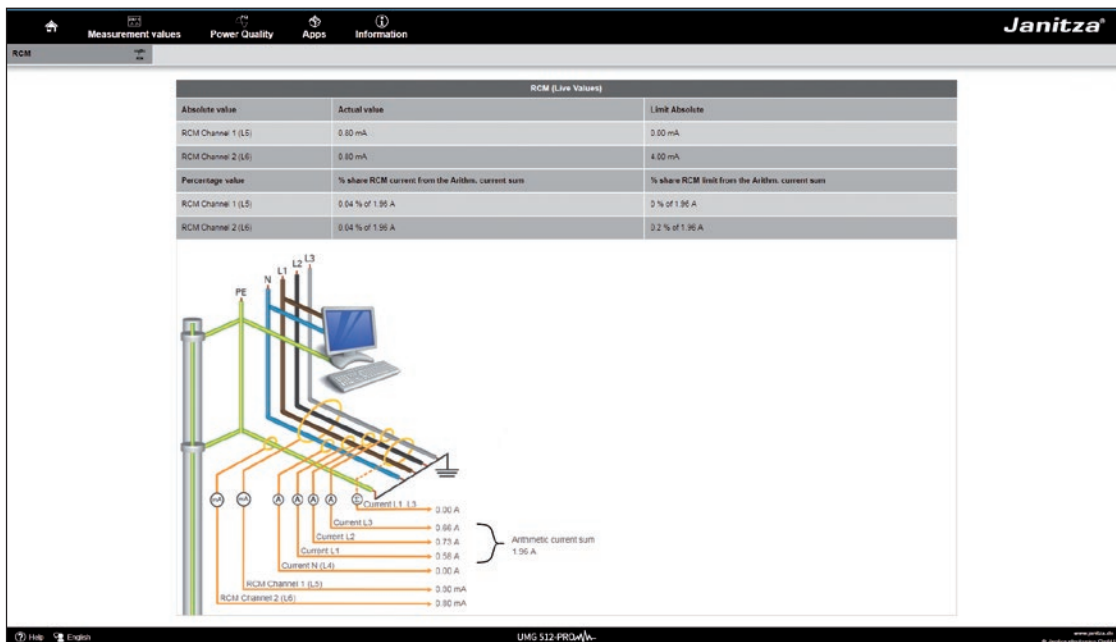

Fig. Device homepage RCM

13. 1. 5 Events

You can use the “Events” item to display a graphical illustration of the recorded events such as overcurrent or undervoltage. For more information on event recording, see chapter “11. 3. 3 Events”.

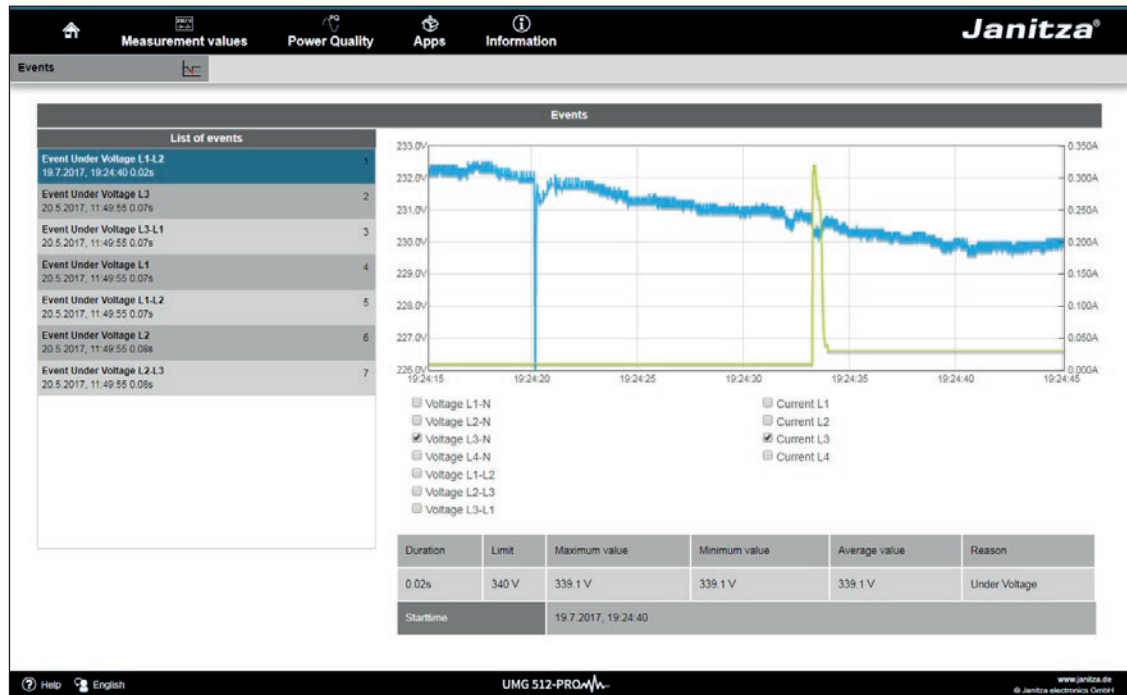

Fig. Event records

13.2 Power quality

The “Power quality” section (PQ) provides you with the option of calling the PQ status in a clear way according to common standards. Here, you have access to permanent power quality monitoring in accordance with:

- EN 50160 in energy supply networks.
- IEC 61000-2-4 in customer supply networks.

The display is based on the traffic light principle, which makes it easy to detect events that do not meet the relevant quality requirements without in-depth knowledge.

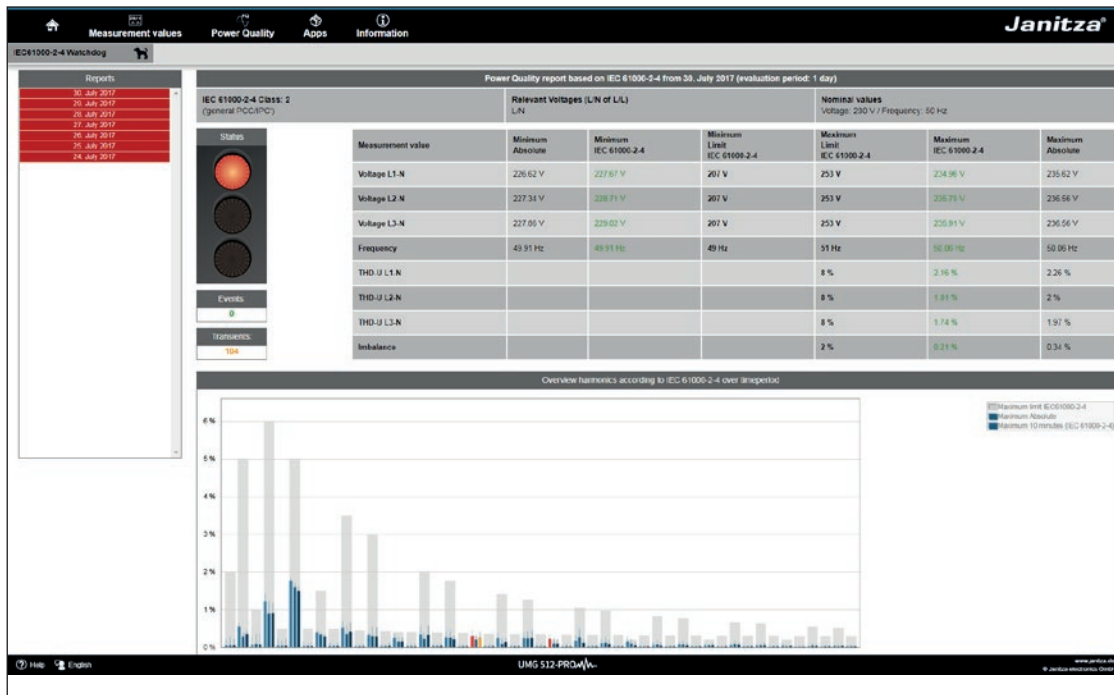

Fig. IEC 61000-2-4 parameters with traffic-light principle

13.3 Apps

You have the option of extending the functions on your device retrospectively by installing additional apps.

13.3.1 Push Service

The push service is an example of an app installed in the factory. The push service sends measured values directly from the device to a cloud or portal solution chosen by you, such as the Janitza Energy Portal.

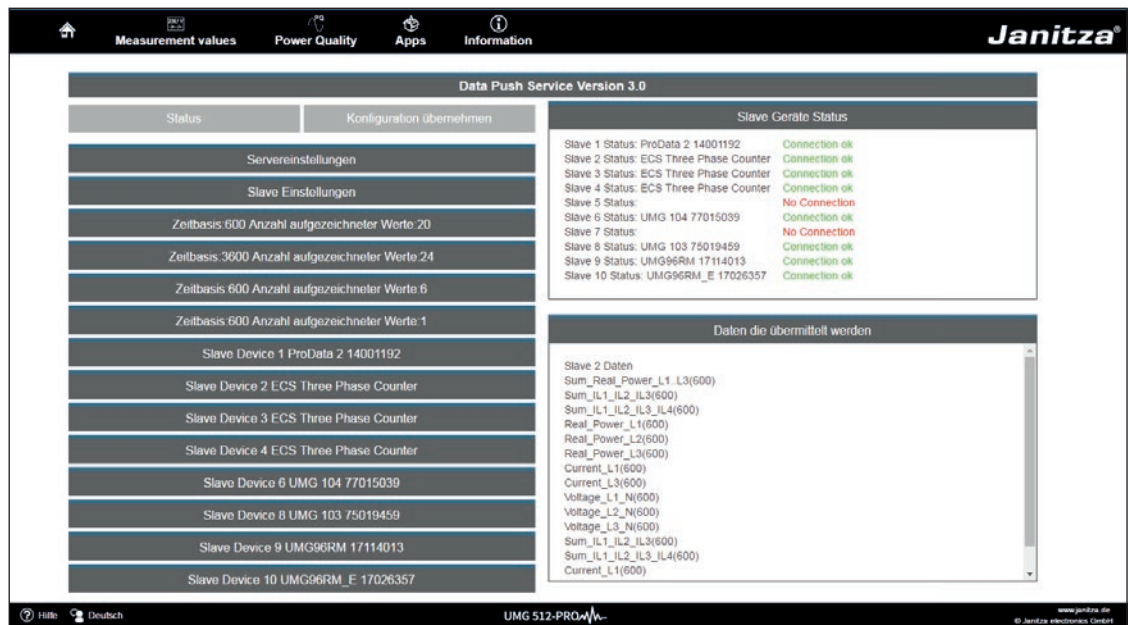

Fig. Push Service

13.4 Information

13.4.1 Device information

You can use the “Device information” menu item to obtain all information and settings that you can change on the device.

13.4.2 Display

The display item provides you with the display of your device, which corresponds to the real display.

You can control the device remotely here by clicking the control buttons using the mouse.

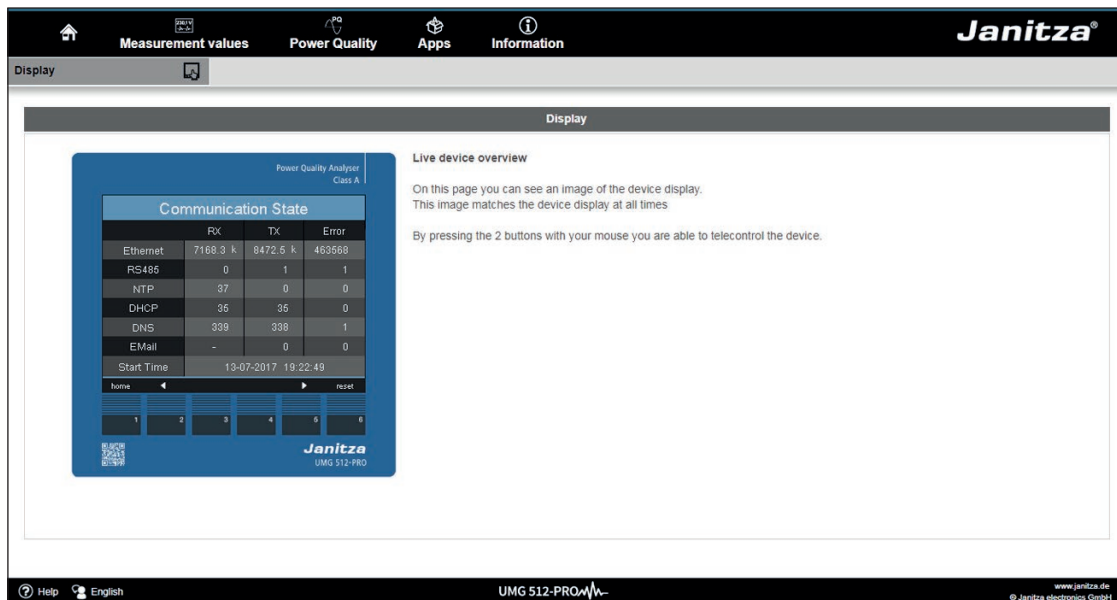

Fig. Operating the UMG 512-PRO via the device homepage

13.4.3 Downloads

You can use the “Downloads” item to access the download area on the Janitza homepage. You can download catalogues and operation manuals from here.

14. Service and maintenance

The device underwent various safety checks before delivery and is marked with a seal. If a device is open, the safety checks must be repeated. Warranty claims will only be accepted if the device is unopened.

14.1 Repair and calibration

Repair work and calibration can be carried out by the manufacturer only.

14.2 Front film

The front film can be cleaned with a soft cloth and standard household cleaning agent. Do not use acids and products containing acid for cleaning.

14.3 Disposal

Observe the national regulations! If necessary, dispose of individual parts according to their properties and existing country-specific regulations, e.g. as:

- Electronic waste
- Plastics
- Metals

or commission a certified disposal company with scrapping.

14.4 Service

Should questions arise, which are not described in this manual, please contact the manufacturer directly.

We will need the following information from you to answer any questions:

- device name (see rating plate)
- serial number (see rating plate)
- software release (see measured value indication)
- measured voltage and supply voltage
- precise description of the error.

14.5 Device calibration

The devices are adjusted by the manufacturer prior to delivery. Recalibrating the device is not necessary providing that the environmental conditions are complied with.

14.6 Calibration intervals

We recommend having the device re-calibrated by the manufacturer or an accredited laboratory every 5 years approximately.

14.7 Firmware update

In order to carry out a firmware update, connect the device to a computer via Ethernet and access it using the GridVis® software.

Open the firmware update wizard by clicking “Update device” in the “Extras” menu.

Select the relevant update file and carry out the update.

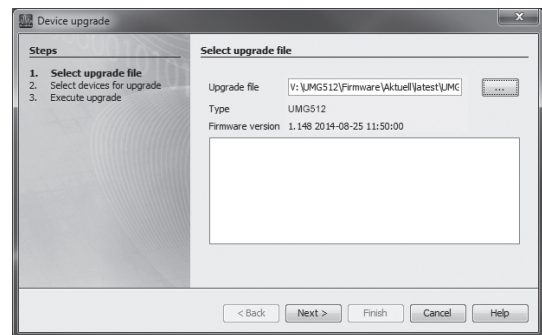

Fig. GridVis® software firmware update wizard



NOTE!

Firmware may **not** be updated via the RS485 interface.

14.8 Battery

The internal clock is fed from the supply voltage. If the supply voltage fails then the clock is powered by the battery. The clock provides date and time information, for the records, min. and max. values and events, for example.

The life expectancy of the battery is at least 5 years with a storage temperature of +45 °C. The typical life expectancy of the battery is 8 to 10 years.

The battery (type CR2450 / 3 V) can be replaced by the user.

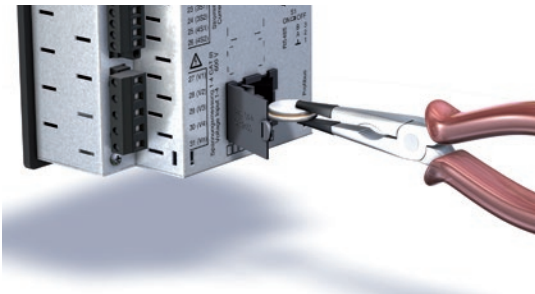

Fig. Replacing the battery using long-nose pliers

15. Procedure in the event of faults

Possible fault	Cause	Remedy
No display	External fuse for the power supply voltage has tripped.	Replace fuse.
No current display	Measured voltage is not connected.	Connect the measured voltage.
	Measurement current is not connected.	Connect measuring-circuit current.
Current displayed is too high or too low.	Current measurement in the wrong phase.	Check connection and correct if necessary.
	Current transformer factor is incorrectly programmed.	Read out and program the CT ratio on the current transformer.
	The current peak value at the measurement input was exceeded by harmonic components.	Install current transformer with a larger CT ratio.
	The current at the measurement input fell short of.	Install current transformer with a smaller CT ratio.
Voltage displayed is too high or too low.	Measurement in the wrong phase.	Check connection and correct if necessary.
	Voltage transformer incorrectly programmed.	Read out and program the voltage transformer ratio at the voltage transformer.
Voltage displayed is too low.	Measurement range exceeded.	Use voltage transformers.
	The peak voltage value at the measurement input has been exceeded by the harmonics.	Attention! Ensure the measurement inputs are not overloaded.
Phase shift ind/cap.	A current circuit is assigned to the wrong voltage circuit.	Check connection and correct if necessary.
Active power, consumption/supply reversed.	At least one current transformer connection is mixed up/reversed.	Check connection and correct if necessary.
	A current circuit is assigned to the wrong voltage circuit.	Check connection and correct if necessary.

Possible fault	Cause	Remedy
Active power too high or too low.	The programmed CT ratio is incorrect.	Read out and program the CT ratio on the current transformer
	The current circuit is assigned to the wrong voltage circuit.	Check connection and correct if necessary.
	The programmed voltage transformer ratio is incorrect.	Read out and program the voltage transformer ratio at the voltage transformer.
An output is not responding.	The output was incorrectly programmed.	Check the settings and correct if necessary.
	The output was incorrectly connected.	Check connection and correct if necessary.
Measurement range exceeded display (overload)	Voltage and current measurement input outside the measurement range (Also see section "12. 8 Measurement range exceeded")	Check connection and correct if necessary.
		Use suitable voltage and current transformers.
		Read out and program the voltage or CT ratio on the transformer.
No connection with the device.	RS485	
	Device address is incorrect.	Correct the device address.
	Different bus speeds (baud rate).	Correct the speed (baud rate).
	Incorrect protocol.	Correct the protocol.
	Termination missing.	Terminate the bus with a termination resistor.
	Ethernet	
	IP device address is incorrect.	Correct the IP device address.
	Incorrect addressing mode	Correct the IP address assignment mode
Device still does not work despite the above measures.	Device defective.	Send the device to the manufacturer for inspection and testing along with an accurate fault description.

16. Technical data

General	
Net weight (with attached connectors)	approx. 1080 g
Device dimensions	Approx. l = 144 mm, w = 144 mm, h = 75 mm
Battery	Type Li-Mn CR2450, 3 V (approval i.a.w. UL 1642)
Clock (temperature range -40 °C to +85 °C)	+5 ppm (corresponding to approx. 3 minutes per year)

Transport and storage	
The following information applies to devices which are transported or stored in the original packaging.	
Free fall	1 m
Temperature	-25 °C to +70 °C

Ambient conditions during operation	
The device is intended for weatherproof, fixed installation and must be connected to the ground wire connection! Protection class I in acc. with IEC 60536 (VDE 0106, Part 1).	
Working temperature range	-10 °C to +55 °C
Relative humidity	5 to 95% RH (at 25°C without condensation)
Operating altitude	0 to 2000 m above sea level
Pollution degree	2
Mounting position	Upright
Ventilation	Forced ventilation is not required.
Protection against ingress of solid foreign bodies and water - Front - Rear	IP40 in acc. with EN60529 IP20 in acc. with EN60529

16.1 Supply voltage

Supply voltage	
Installations of overvoltage category	300 V CAT III
Protection of the supply voltage (fuse)	6 A, type C (approved i.a.w. UL/IEC)
230 V option: - Nominal range - Operating range - Power consumption	95 V to 240 V (50/60 Hz) / DC 80 V to 300 V +-10% of nominal range max. 7 W / 14 VA
24V option: - Nominal range - Operating range - Power consumption	48 V to 110 V (50/60 Hz) / DC 24 to 150 V +-10% of nominal range max. 9 W / 13 VA

Terminal connection capacity (supply voltage)	
Connectable conductors. Only one conductor can be connected per terminal!	
Single core, multi-core, fine-stranded	0.2 - 2.5 mm ² , AWG 24 - 12
Terminal pins, core end sheath	0.25 - 2.5 mm ²
Tightening torque	0.5 - 0.6 Nm
Stripping length	7 mm

16.2 Voltage and current measurement

Current measurement	
Rated current	5 A
Resolution	0.1 mA
Metering range	0.001 to 7 Arms
Measurement range exceeded (overload)	as of 7 Amps
Crest factor	1.41
Overvoltage category	230 V option: 300 V CAT III 24 V option: 300 V CAT II
Measurement surge voltage	4 kV
Power consumption	approx. 0.2 VA (Ri = 5 mOhm)
Overload for 1 sec.	120 A (sinusoidal)
Sampling rate	25.6 kHz / phase

Voltage measurement	
The voltage measurement inputs are suitable for measurements in the following power supply systems:	
Three-phase 4-conductor systems with rated voltages up to	417 V / 720 V (+10%) 347 V / 600 V (UL listed)
Three-phase 3-conductor systems with rated voltages up to	600 V (+10%)
From a safety and reliability perspective, the voltage measurement inputs are designed as follows:	
Overvoltage category	600 V CAT III
Measurement surge voltage	6 kV
Protection of voltage measurement	1-10 A
Metering range L-N	0 ¹⁾ to 600 Vrms
Metering range L-L	0 ¹⁾ to 1000 Vrms
Resolution	0.01 V
Crest factor	1.6 (related to 600 Vrms)
Impedance	4 MOhm / phase
Power consumption	approx. 0.1 VA
Sampling rate	25.6 kHz / phase
Transients	39 µs
U _{din} ²⁾ i.a.w. EN61000-4-30	100 to 250 V
Flicker range (dU/U)	27.5%
Frequency range of the fundamental oscillation - Resolution	15 Hz to 440 Hz 0.001 Hz

1) The device can only determine measured values, if an L-N voltage of greater than 10 Veff or an L-L voltage of greater than 18 Veff is applied to at least one voltage measurement input.

2) U_{din} = arranged input voltage according to DIN EN 61000-4-30

Terminal connection capacity (voltage and current measurement)	
Connectable conductors. Only one conductor can be connected per terminal!	
Single core, multi-core, fine-stranded	0.2 - 2.5 mm ² , AWG 24-12
Terminal pins, core end sheath	0.25 - 2.5 mm ²
Tightening torque	0.5 - 0.6 Nm
Stripping length	7 mm

16.3 Residual current monitoring

Residual current monitoring (RCM)	
Rated current	30 mAmps
Metering range	0 to 40 mAmps
Triggering current	100 μ A
Resolution	1 μ A
Crest factor	1.414 (related to 40 mA)
Burden	4 Ohm
Overload for 1 sec.	5 A
Sustained overload	1 A
Overload for 20 ms	50 A
Residual current monitoring	i.a.w. IEC/TR 60755 (2008-01), type A 
Maximum external burden	300 Ohm (for cable break detection)

Terminal connection capacity (residual current monitoring)	
Connectable conductors. Only one conductor can be connected per terminal!	
Rigid/flexible	0.14 - 1.5 mm ² , AWG 28-16
Flexible with core end sheath without plastic sleeve	0.20 - 1.5 mm ²
Flexible with core end sheath with plastic sleeve	0.20 - 1.5 mm ²
Stripping length	7 mm
Tightening torque	0.20 - 0.25 Nm
Cable length	up to 30 m unshielded, from 30 m shielded

Potential separation and electrical safety for the residual current monitoring inputs
<ul style="list-style-type: none"> - The RCM measurement inputs are double-insulated from the current and voltage measurement inputs, as well as the supply voltage. - There is no insulation from the thermistor input. - There is only a functional insulation from the Ethernet, Profibus and RS485 interfaces and the digital I/Os. - The residual current transformer connected and the lines to be measured must each have at least one additional or basic insulation per IEC61010-1:2010 for the mains voltage present.

16.4 Thermistor input

Thermistor input 3-wire measurement	
Update time	1 second
Connectable sensors	PT100, PT1000, KTY83, KTY84
Total burden (sensor + cable)	Max. 4 kOhm
Cable length	up to 30 m unshielded, from 30 m shielded

Sensor type	Temperature range	Resistor range	Measurement uncertainty
KTY83	-55 °C to +175 °C	500 Ohm to 2.6 kOhm	± 1.5% rng
KTY84	-40 °C to +300 °C	350 Ohm to 2.6k Ohm	± 1.5% rng
PT100	-99 °C to +500 °C	60 Ohm to 180 Ohm	± 1.5% rng
PT1000	-99 °C to +500 °C	600 Ohm to 1.8k Ohm	± 1.5% rng

Terminal connection capacity (thermistor input) Connectable conductors. Only one conductor can be connected per terminal!	
Single core, multi-core, fine-stranded	0.08 - 1.5 mm ²
Terminal pins, core end sheath	1 mm ²

Potential separation and electrical safety for the thermistor inputs
<ul style="list-style-type: none"> - The thermistor input is double-insulated from the current and voltage measurement inputs, as well as the supply voltage. - There is no insulation from the RCM measurement input. - There is only a functional insulation from the Ethernet, Profibus and RS485 interfaces and the digital I/Os. - The external temperature sensor must be double insulated from the system parts that carry voltages that are dangerous to touch (per IEC61010-1:2010).

16.5 Digital inputs and outputs

Digital inputs 2 Digital inputs with a joint earth	
Maximum counter frequency	20 Hz
Response time (Jasic program)	200 ms
Input signal present	18 V to 28 V (typically 4 mA) (SELV or PELV supply)
Input signal not present	0 to 5 V DC, current less than 0.5 mA
Cable length	up to 30 m unshielded, from 30 m shielded

Digital outputs 2 digital outputs with a joint earth; opto coupler, not short-circuit proof	
Supply voltage	20 V - 30 V DC (SELV or PELV supply)
Switching voltage	max. 60 V DC
Switching current	max. 50 mAeff AC/DC
Response time (Jasic program)	200 ms
Switching frequency	Max. 20 Hz
Cable length	up to 30 m unshielded, from 30 m shielded

Terminal connection capacity (digital inputs and outputs)	
Rigid/flexible	0.14 - 1.5 mm ² , AWG 28-16
Flexible with core end sheath without plastic sleeve	0.25 - 1.5 mm ²
Flexible with core end sheath with plastic sleeve	0.25 - 0.5 mm ²
Tightening torque	0.22 - 0.25 Nm
Stripping length	7 mm

Potential separation and electrical safety for the digital inputs and outputs
<ul style="list-style-type: none"> - The digital inputs and outputs are double-insulated from the current and voltage measurement inputs, as well as the supply voltage. - There is only a functional insulation from the Ethernet, Profibus and RS485 interfaces and the digital I/Os, and from one another. - The external auxiliary voltage to be connected must be compliant with SELV or PELV.

16.6 Interfaces

RS485 interface 3-wire connection with GND, A, B	
Protocol	Modbus RTU/slave, Modbus RTU/master, Modbus RTU /Gateway
Transmission rate	9.6 kbps, 19.2 kbps, 38.4 kbps, 57.6 kbps, 115.2 kbps, 921.6 kbps
Termination resistor	Can be activated by micro switch

Profibus interface	
Connection	SUB D 9-pole
Protocol	Profibus DP/V0 as per EN 50170
Transmission rate	9.6 kBaud to 12 MBaud

Ethernet interface	
Connection	RJ45
Function	Modbus gateway, embedded web server (HTTP)
Protocols	CP/IP, EMAIL (SMTP), DHCP client (BootP), Modbus/TCP, Modbus RTU over Ethernet, FTP, ICMP (Ping), NTP, TFTP, BACnet (optional), SNMP,

Potential separation and electrical safety for the interfaces	
<ul style="list-style-type: none"> - The Ethernet, Profibus and RS485 interfaces are double-insulated from the current and voltage measurement inputs, as well as the supply voltage. - There is only a functional insulation from the RSM measurement inputs and thermistor inputs, as well as from the digital I/Os and from one another. - The interfaces for the devices connected here must have a double or reinforced insulation to mains voltages (in accordance with IEC 61010-1: 2010). 	

16.7 Function parameters

16.7.1 Measurements with 50/60 Hz

The measurements are carried out via current transformer ..5A.

Function	Symbol	Precision class	Metering range	Display range
Total active power	P	0.2 ⁵⁾ (IEC61557-12)	0 to 15.3 kW	0 W to 9999 GW *
Total reactive power	QA ⁶⁾ , Qv ⁶⁾	1 (IEC61557-12)	0 to 15.3 kvar	0 varh .. 9999 Gvar *
Total apparent power	SA, Sv ⁶⁾	0.2 ⁵⁾ (IEC61557-12)	0 to 15.3 kVA	0 VA to 9999 GVA *
Total active energy	Ea	0.2S ^{9/7)} (IEC61557-12)	0 to 15.3 kWh	0 Wh to 9999 GWh *
Total reactive energy	ErA ⁶⁾ , ErV ⁶⁾	1 (IEC61557-12)	0 to 15.3 kvarh	0 varh .. 9999 Gvarh *
Total apparent energy	EapA, EapV ⁶⁾	0.2 ⁵⁾ (IEC61557-12)	0 to 15.3 kVAh	0 VAh to 9999 GVAh *
Frequency	f	0.05 (IEC61557-12)	40 to 70 Hz	40 Hz to 70 Hz
Phase current	I	0.1 (IEC61557-12)	0.001 to 8.5 Arms	0 A to 9999 kA
Measured neutral conductor current	IN	0.1 (IEC61557-12)	0.001 to 8.5 Arms	0 A to 9999 kA
Residual currents I5, I6	IDIFF	1 (IEC61557-12)	0 to 40 mAmps	0 A to 9999 kA
Computed neutral conductor current	INc	0.5 (IEC61557-12)	0.001 to 25.5 A	0 A to 9999 kA
Voltage	U L-N	0.1 (IEC61557-12)	10 to 600 Vrms	0 V to 9999 kV
Voltage	U L-L	0.1 (IEC61557-12)	18 to 1000 Vrms	0 V to 9999 kV
Power factor	PFA, PFV	0.5 (IEC61557-12)	0.00 to 1.00	0 to 1
Short-term flicker, long-term flicker	Pst, PIt	Cl. A (IEC61000-4-15)	0.4 Pst to 10.0 Pst	0 to 10
Voltage dips	Udip	0.2 (IEC61557-12)	10 to 600 Vrms	0 V to 9999 kV
Voltage increases	Uswl	0.2 (IEC61557-12)	10 to 600 Vrms	0 V to 9999 kV
Transient overvoltages	Utr	0.2 (IEC61557-12)	10 to 600 Vrms	0 V to 9999 kV
Voltage interruptions	Uint	Duration +- 1 cycle	-	-
Voltage unbalance ¹⁾	Unba	0.2 (IEC61557-12)	10 to 600 Vrms	0 V to 9999 kV
Voltage unbalance ²⁾	Unb	0.2 (IEC61557-12)	10 to 600 Vrms	0 V to 9999 kV
Voltage harmonics	Uh	Cl. 1 (IEC61000-4-7)	Up to 2.5 kHz	0 V to 9999 kV
THD of the voltage ³⁾	THDu	1.0 (IEC61557-12)	Up to 2.5 kHz	0% to 999 %
THD of the voltage ⁴⁾	THD-Ru	1.0 (IEC61557-12)	Up to 2.5 kHz	0% to 999 %
Current harmonics	Ih	Cl. 1 (IEC61000-4-7)	Up to 2.5 kHz	0 A to 9999 kA
THD of the current ³⁾	THDi	1.0 (IEC61557-12)	Up to 2.5 kHz	0% to 999 %
THD of the current ⁴⁾	THD-Ri	1.0 (IEC61557-12)	Up to 2.5 kHz	0% to 999 %
Mains signal voltage (interharmonics voltage)	MSV	IEC 61000-4-7 class 1	10% – 200% of IEC 61000-2-4 class 3	0 V to 9999 kV

16. 7. 2 Measurements in the range 15 to 440 Hz

Function	Symbol	Precision class	Metering range	Display range
Total active power	P	2 (IEC61557-12)	0 to 15.3kW	0 W to 9999 GW *
Total reactive power	QA [§] , Qv [§]	2 (IEC61557-12)	0 to 15.3 kvar	0 varh .. 9999 Gvarh *
Total apparent power	SA, Sv [§]	1 (IEC61557-12)	0 to 15.3 kVA	0 VA to 9999 GVA *
Total active energy	Ea	2 (IEC61557-12)	0 to 15.3 kWh	0 Wh to 9999 GWh *
Total reactive energy	ErA [§] , ErV [§]	2 (IEC61557-12)	0 to 15.3 kvarh	0 varh .. 9999 Gvarh *
Total apparent energy	EapA, EapV [§]	1 (IEC61557-12)	0 to 15.3 kVAh	0 VAh to 9999 GVAh *
Frequency	f	0.05 (IEC61557-12)	15 to 440 Hz	15 Hz to 440 Hz
Phase current	I	0.5 (IEC61557-12)	0.001 to 8.5 Arms	0 A to 9999 kA
Measured neutral conductor current	IN	0.5 (IEC61557-12)	0.001 to 8.5 Arms	0 A to 9999 kA
Residual currents I5, I6	IDIFF	1 (IEC61557-12)	0 to 40 mAmps	0 A to 9999 kA
Computed neutral conductor current	INc	1.5 (IEC61557-12)	0.001 to 25.5 A	0 A to 9999 kA
Voltage	U L-N	0.5 (IEC61557-12)	10 to 600 Vrms	0 V to 9999 kV
Voltage	U L-L	0.5 (IEC61557-12)	18 to 1000 Vrms	0 V to 9999 kV
Power factor	PFA, PFV	2 (IEC61557-12)	0.00 to 1.00	0 to 1
Short-term flicker, long-term flicker	Pst, Plt	-	-	-
Voltage dips	Udip	0.5 (IEC61557-12)	10 to 600 Vrms	0 V to 9999 kV
Voltage increases	Uswl	0.5 (IEC61557-12)	10 to 600 Vrms	0 V to 9999 kV
Transient overvoltages	Utr	0.5 (IEC61557-12)	10 to 600 Vrms	0 V to 9999 kV
Voltage interruptions	Uint	Duration +- 1 cycle	-	-
Voltage unbalance ¹⁾	Unba	0.5 (IEC61557-12)	10 to 600 Vrms	0 V to 9999 kV
Voltage unbalance ²⁾	Unb	0.5 (IEC61557-12)	10 to 600 Vrms	0 V to 9999 kV
Voltage harmonics	Uh	Cl. 2 (IEC61000-4-7)	Up to 2.5 kHz	0 V to 9999 kV
THD of the voltage ³⁾	THDu	2.0 (IEC61557-12)	Up to 2.5 kHz	0% to 999 %

Declarations

- 1) In relation to the amplitude.
- 2) In relation to phase and amplitude.
- 3) In relation to fundamental oscillation.
- 4) In relation to effective value.
- 5) Precision class 0.2 with.../ 5A converter.
Precision class 0.5 with.../ 1A converter.
- 6) Calculation from fundamental oscillation.
- 7) Precision class 0.2S per IEC62053-22

* When the max. total working value s have been reached, the display returns to 0 W.

16.8 Specifications as per IEC 61000-4-30

Characteristic	Uncertainty	Metering range
5.1 Frequency	± 10 mHz	42.5 Hz – 57.5 Hz, 51 Hz – 69 Hz
5.2 Supply voltage level	± 0.1% of U _{din}	10% – 150% of U _{din}
5.3 Flicker	± 5% of measured value	0.2 – 10 P _{st}
5.4 Dips and excessive increases	Amplitude: ± 0.2% of U _{din} Duration: ± 1 period	N/A
5.5 Voltage interruptions	Duration: ± 1 period	N/A
5.7 Unbalance	± 0.15%	0.5% – 5% u ₂ 0.5% – 5% u ₀
5.8 Harmonics	IEC 61000-4-7 class 1	10% – 200% of Class 3 of IEC 61000-2-4
5.9 Interharmonics	IEC 61000-4-7 class 1	10% – 200% of Class 3 of IEC 61000-2-4
5.10 Mains signal voltage	In the range 3%-15% of U _{din} , ± 5% of U _{din} . In the range 1%-3% of U _{din} , ± 0.15% of U _{din} . There are no uncertainty requirements for values < 1% of U _{din} .	0% – 15% of U _{din}
5.12 Downward/upward deviation	± 0.1% of U _{din}	10% – 150% of U _{din}



NOTE!

To ensure that two measurement devices achieve the same measurement results in a 10 minute compensation interval, we recommend synchronising time measurement in the device using an external time signal.



NOTE!

The device meets the requirements according to IEC 61000-4-30 class A for:

- compensation
- time uncertainty
- marking concept
- transient influence quantities

16.9 Dimension diagrams

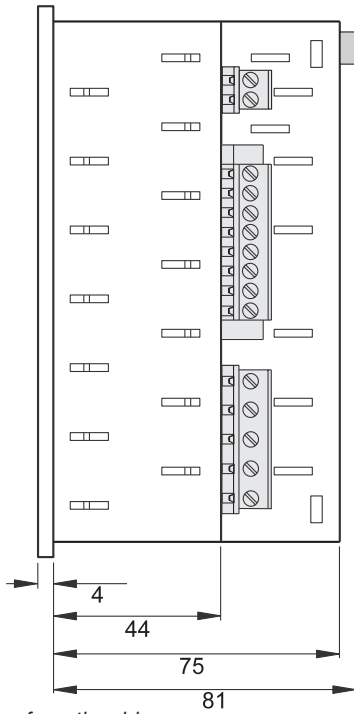

Fig. View from the side

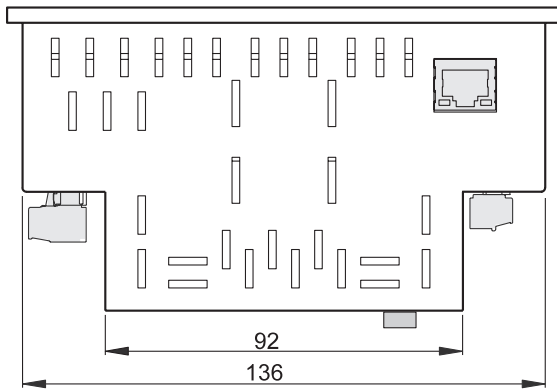

Fig. View from below

17. Menu guide overview

17.1 Configuration menu overview

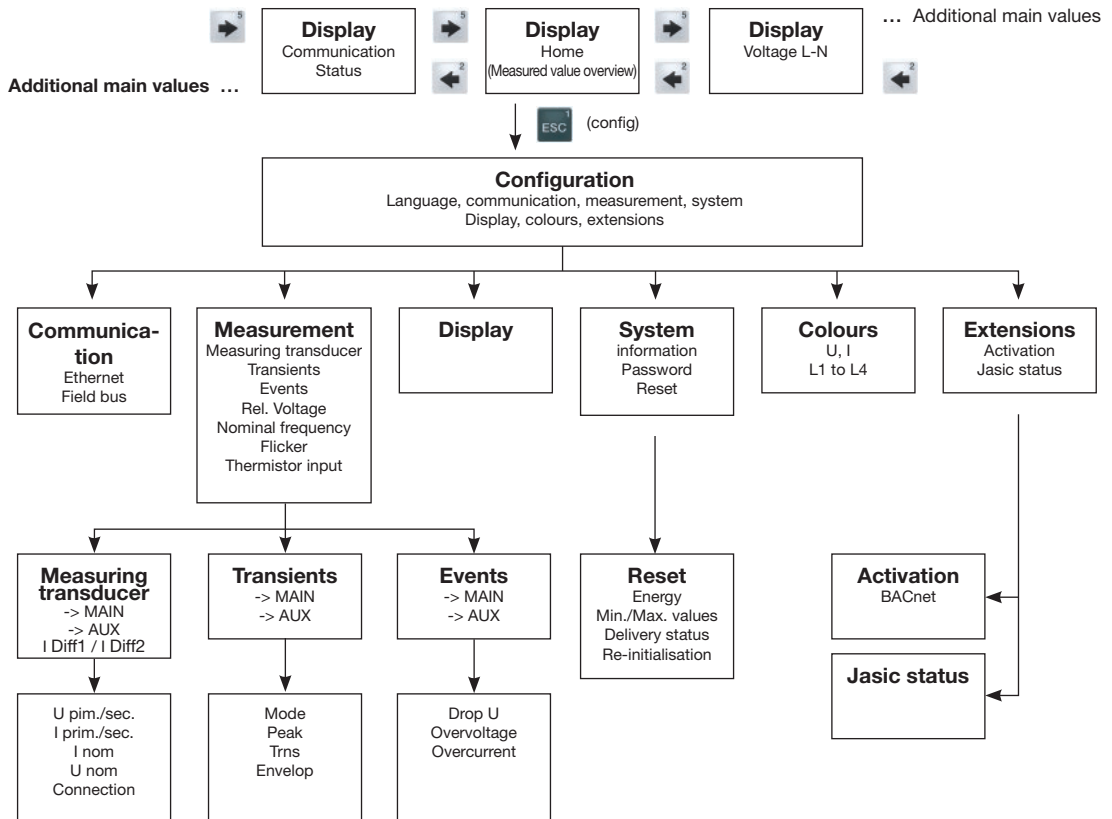

Fig. Schematic illustration of the menu guide for the configuration menu

17.2 Overview of measured value indications

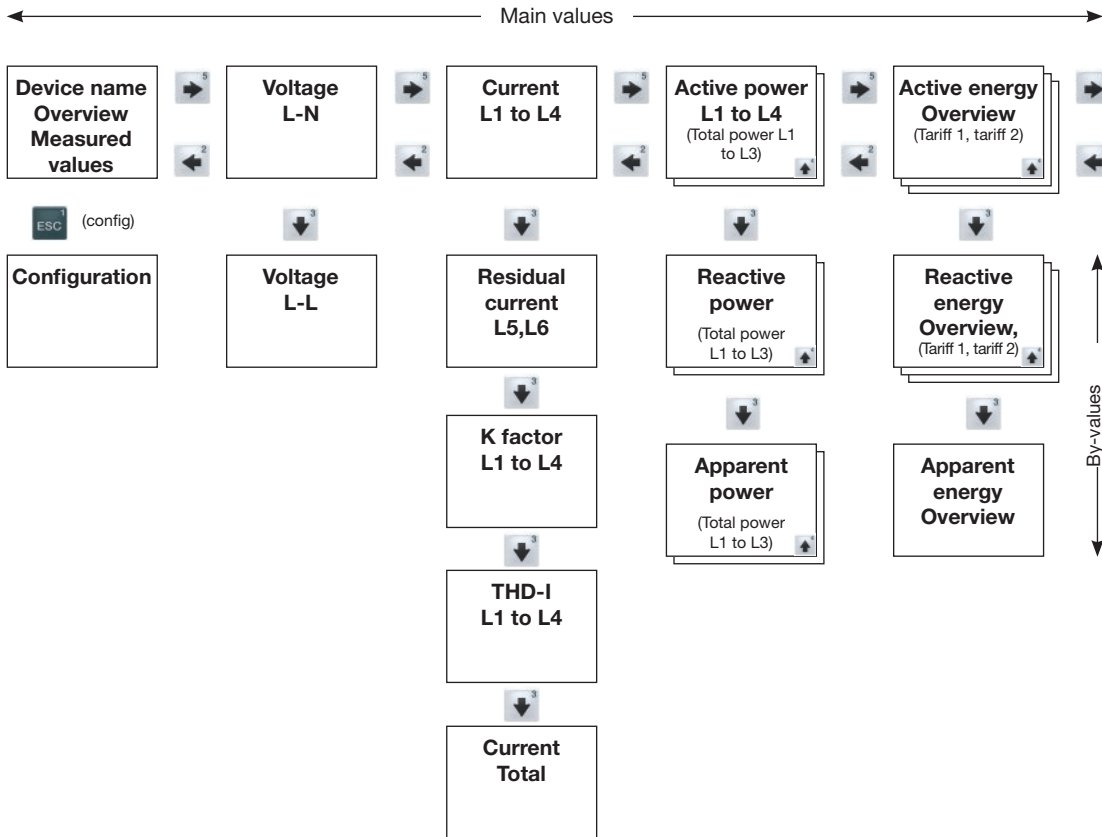

Fig. Schematic illustration of the menu guide for the measured value indications, part 1

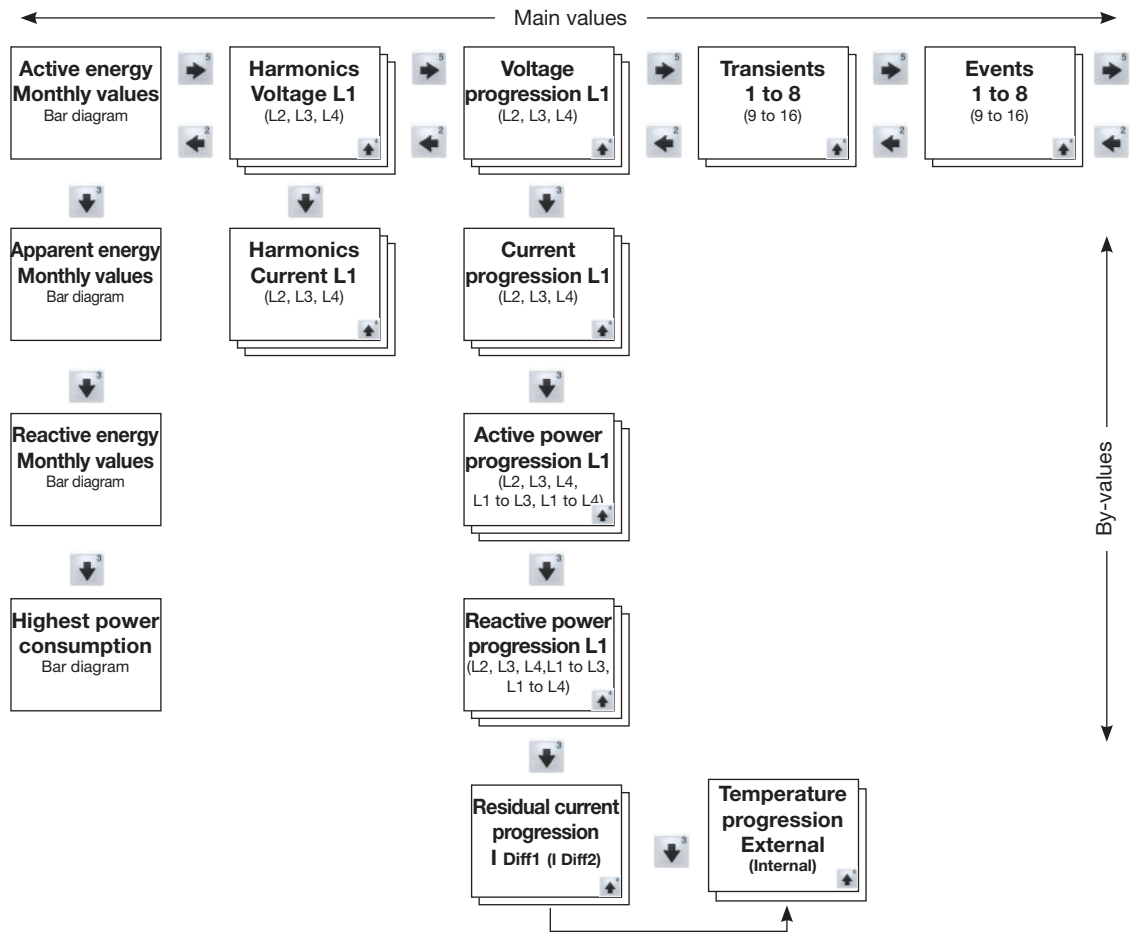

Fig. Schematic illustration of the menu guide for the measured value indications, part 2

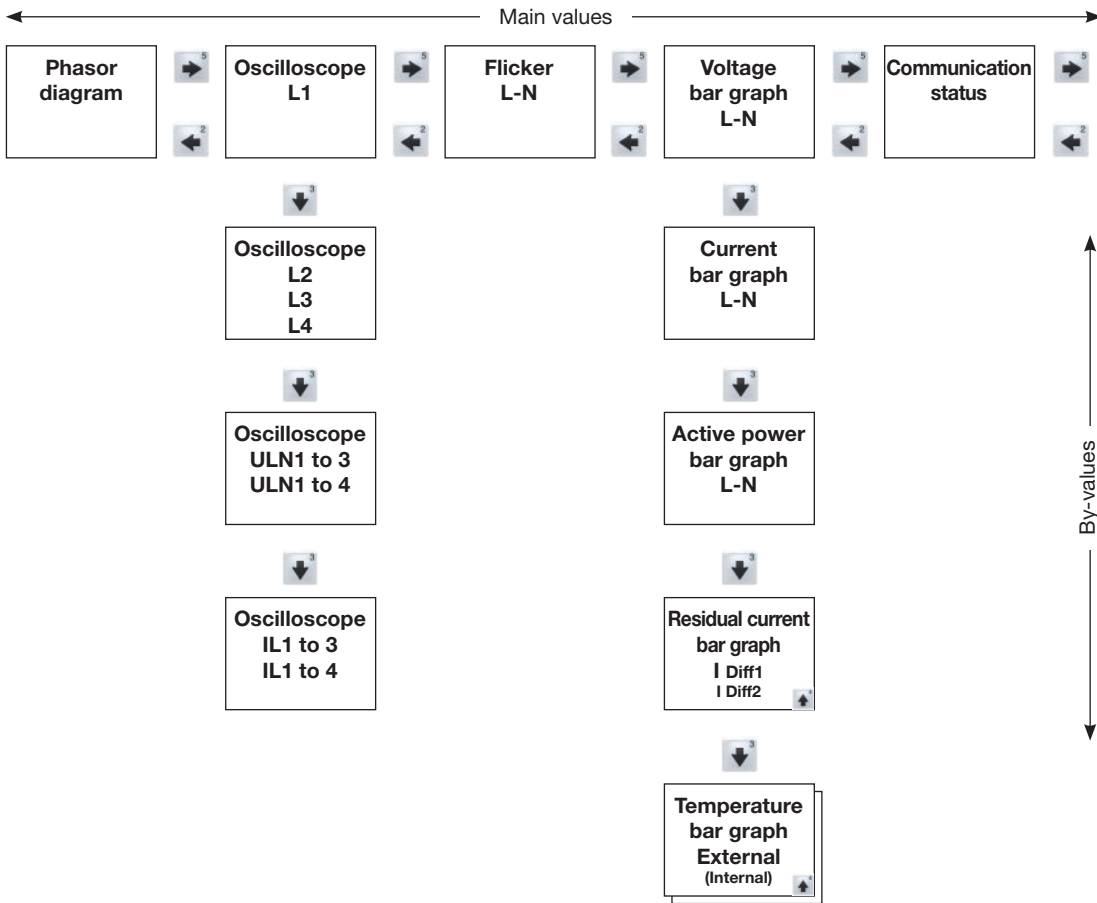

Fig. Schematic illustration of the menu guide for the measured value indications, part 3

18. Connection example

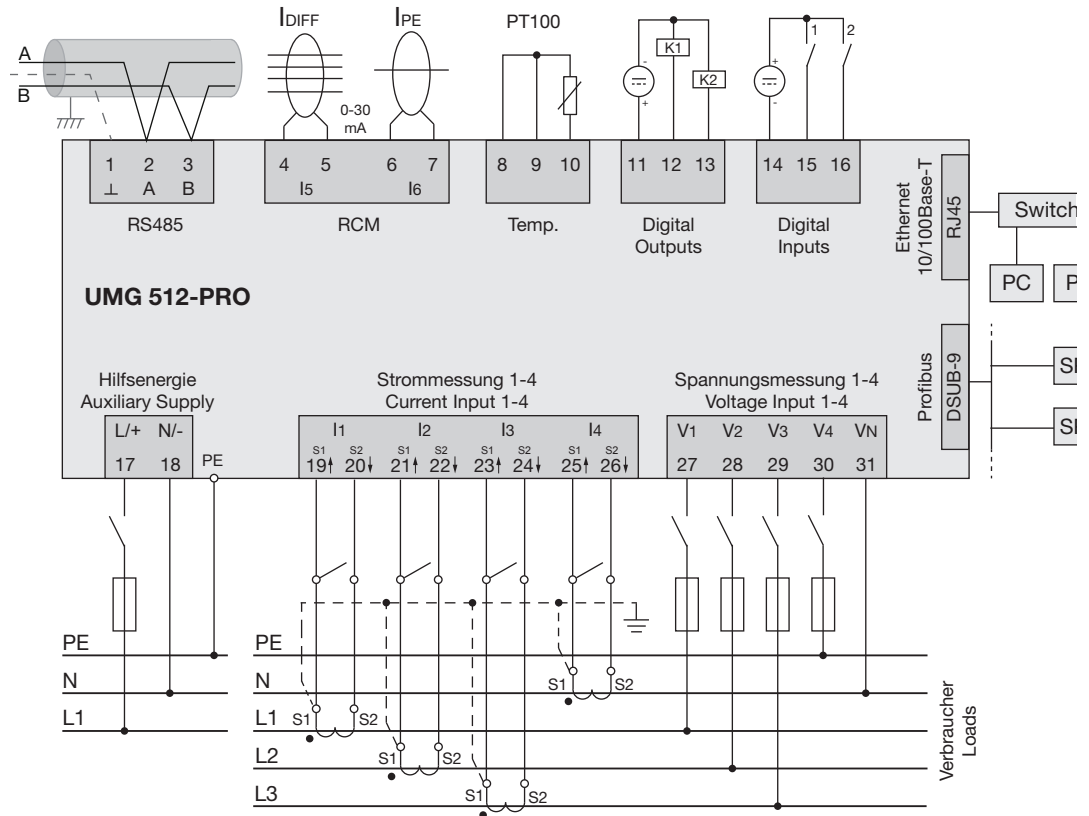

Fig. Schematic drawing of connection example for the UMG 512-PRO

