

Power Analyzer

UMG 96-PQ-L

(from firmware 3.3 - hardware index 1)

User manual and technical data

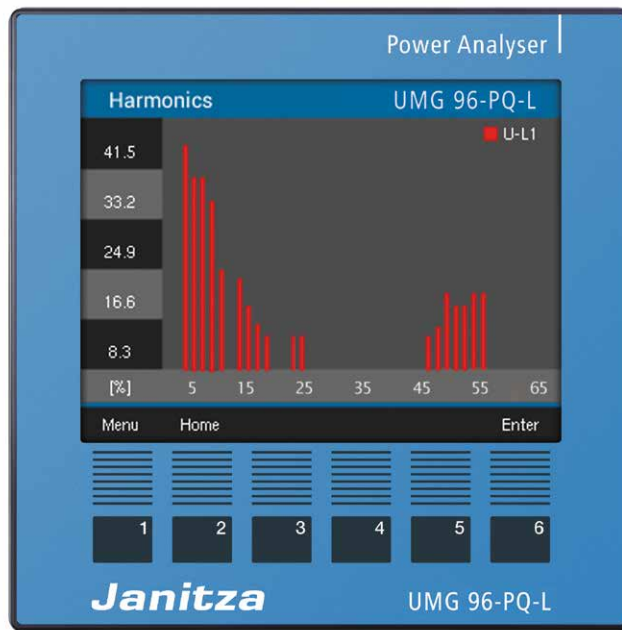

Image may differ from the original!

UMG 96-PQ-L (from firmware 3.3 / hardware index 1)

Measurement device for recording energy quantities

Doc. no.: 2.061.073.3.b

Date: 12/2021

The German version is the original edition of the documentation

Subject to technical changes.

The contents of our documentation have been compiled with great care and reflect the current state of the information available to us. Nonetheless, we wish to point out that updates of this document are not always possible at the same time as technical refinements are implemented in our products. Please see our website under www.janitza.de for the current version.

Please see our website under www.janitza.de for the current version.

TABLE OF CONTENTS

1. Information on the device and the user manual	10
1.1 Disclaimer	10
1.2 Copyright notice	10
1.3 Technical changes.	10
1.4 About this user manual	10
1.5 Defective device/disposal	11
2. Safety	12
2.1 Display of warning notices and safety information	12
2.2 Hazard levels.	12
2.3 Product safety.	13
2.4 Dangers when handling the device.	13
2.5 Electrically qualified personnel	14
2.6 Warranty in the event of damage	14
2.7 Safety information for handling current transformers and measurement devices with residual current measurement	14
2.8 Handling batteries/accumulators	15
3. Product description	16
3.1 Device description	16
3.2 Incoming goods inspection.	16
3.3 Intended use	17
3.4 Performance characteristics	17
3.5 EU conformity declaration	18
3.6 FCC Declaration of Conformity.	18
3.7 Scope of delivery	18
3.8 Accessories.	18
3.9 Measuring method	19
3.10 Transformer	19
3.11 Operating concept	19
3.12 GridVis® network analysis software	19
4. Structure of the device.	20
4.1 Front panel - Display and controls	20
4.2 Rear of the device - Connections	21
4.3 Rating plate.	22
5. Mounting.	23
5.1 Installation location	23
5.2 Mounting orientation.	23
5.3 Securing	23

6. Grid systems	24
7. Installation	25
7.1 Nominal voltages	25
7.1.1 Three-phase four-conductor network with grounded neutral conductor	25
7.3.1 Three-phase three-conductor system	26
7.2 Disconnect switch	26
7.3 Supply voltage	26
7.4 Voltage measurement	28
7.4.1 Overvoltage	28
7.4.2 Frequency	28
7.4.3 Connection variants for voltage measurement	29
7.5 Current measurement	30
7.5.1 Current direction	31
7.5.2 Summation current measurement	31
7.5.3 Ammeter	31
7.5.4 Connection variants for current measurement	32
8. Connection and PC connections	34
8.1 Connection variants	34
8.2 RS-485 interface	35
8.3 Shielding	35
8.4 Termination resistors	36
8.5 Bus structure	36
9. Digital inputs and outputs	38
9.1 Digital inputs	38
9.1.1 S0 pulse input	38
9.2 Digital outputs	39
9.3 LED status bar	39
10. Analog outputs	40
11. Operation	41
11.1 Button function	41
11.2 Measuring display “Summary”	41
11.3 Menu	41
11.4 Overview of menu displays	42
11.5 Configuring a new start screen	43

12. Configuration	44
12.1 The Configuration window	44
12.2 Language	44
12.3 Communication	44
12.4 Measurement	46
12.4.1 Current and voltage transformers	46
12.4.2 Connection variant	47
12.4.3 Nominal current	48
12.4.4 Nominal frequency	49
12.5 Display	50
12.5.1 Brightness	50
12.5.2 Standby after	50
12.5.3 Brightness (standby)	50
12.5.4 Colors	51
12.6 System	51
12.6.1 Firmware/Serial number	52
12.6.2 Date/time	52
12.6.3 Password	52
12.6.4 Reset	53
12.7 Modbus editor	55
12.8 Events	57
13. Commissioning	58
13.1 Applying the supply voltage	58
13.2 Measured voltage	58
13.3 Measured current	58
13.4 Frequency	59
13.5 Direction of rotary field	59
13.5.1 Fundamentals on the phasor diagram	60
13.6 Checking of voltage and current inputs by means of phasor diagram	61
13.7 Overage	61
13.8 Checking the time	61
13.9 Control of the power measurement	62
13.10 Control of the communication	62
13.11 Delete min./max. values	64
13.12 Harmonics current (harmonics)	66
13.13 Communication in the bus system	67
13.13.1 RS-485	67

13.14	Digital inputs/outputs	68
13.14.1	Digital inputs	68
13.14.2	Digital outputs	70
13.15	Configuration of the analog output	74
13.16	Drag indicator function	75
13.16.1	Internal synchronization	75
13.16.2	External synchronization	76
13.16.3	Synchronization priority	78
13.16.4	Drag indicator - Measurement device displays	79
13.16.5	Delete drag indicator	80
13.17	Recordings	81
13.17.1	Default settings, memory partition A	82
13.17.2	Default settings, memory partition B	83
13.17.3	Use cases – Recording examples	85
13.18	Internal and external events	86
13.19	Event lists	89
13.20	Tariff switching	90
13.21	Alarms for “Low battery voltage” and “Set time”	91
14.	Overview of measuring displays	92
14.1	Menu overview (Start screen)	92
14.2	Voltage menu	93
14.3	Current menu	94
14.4	Power menu	94
14.5	Energy menu	95
14.6	Consumption overview menu	95
14.7	Drag indicator menu	96
14.8	Harmonics menu	97
14.9	Oscilloscope menu	98
14.10	Events menu	99
14.11	System Info menu	102
15.	Overview of displays in the Configuration menu	104
15.1	Language submenu	104
15.2	Communication submenu	104
15.3	Measurement submenu	105
15.4	Display submenu	105
15.5	System submenu	106
15.6	Modbus editor submenu	106

16. Service and maintenance	108
16.1 Repair and calibration	108
16.2 Front panel foil and display	108
16.3 Service	108
16.4 Device adjustment	108
16.5 Firmware update	108
16.6 Clock/Battery	109
17. Procedure in the event of a malfunction	110
18. Technical data	111
19. Performance characteristics of functions	114
19.1 Modbus addresses of frequently used measured values	116
19.2 Number formats	117
19.3 Note on saving measured values and configuration data	117
19.4 Dimensional drawings	118
19.5 Connection example 1	119

1. Information on the device and the user manual

1.1 Disclaimer

Compliance with the usage information for the devices is a prerequisite for safe operation and attaining the stated performance characteristics and product features.

Janitza electronics GmbH assumes no liability for bodily injury, material damage or financial losses which result from disregard of the usage information.

Make sure that your usage information is readily available and legible.

1.2 Copyright notice

© 2020 - Janitza electronics GmbH - Lahnau.
All rights reserved.

Any reproduction, processing, distribution or other use, in whole or in part, is prohibited.

All trademarks and the rights arising from them are the property of the respective owners of these rights.

1.3 Technical changes

- Make sure that your device matches the user manual.
- This user manual applies to the UMG 96-PQ-L. Separate validities and distinctions are marked.
- First make sure you have read and understood the usage information accompanying the product.
- Keep the usage information associated with the product available for the entire service life and pass it on to any possible subsequent users.
- Find out about device revisions and the associated modifications of the usage information associated with your product at www.janitza.de.
- This manual is also valid for alternative device fronts.

1.4 About this user manual

If you have questions, suggestions or ideas for improvement of the user manual, please let us know via email at: info@janitza.de.

INFORMATION

This user manual describes the device UMG PQ-L and provides information on its operation.

In addition to this user manual, please refer to additional usage information for your device, such as:

- Installation instructions.
- “GridVis® software” quick guide.
- “Safety Information” supplement.

If applicable, also refer to the usage information about expansion modules, such as

- User manuals and
- Installation instructions.

Moreover, the **GridVis®** software has an online help feature and e-learning modules.

INFORMATION

Our usage information uses the grammatical masculine form in a gender-neutral sense! This form always refers equally to women, men and diverse. In order to make the texts more readable, distinctions are not made. We ask for your understanding for these simplifications.

1.5 Defective device/disposal

Before sending **defective devices, modules or components** back to the manufacturer for testing:

- Contact the manufacturer's Support department.
- Send devices, modules or components complete with all accessories.
- When doing so, please bear the terms for transportation in mind.

INFORMATION

Please return defective or damaged devices to Janitza electronics GmbH in accordance with the shipping instructions for air or road freight (complete with accessories).

Observe special regulations for devices with built-in batteries or rechargeable batteries!

Do not attempt to open or repair the device (the component) on your own because otherwise all warranty claims become invalid!

For the **Disposal** of the device please observe national regulations! Dispose of individual parts, as applicable, depending on their composition and existing country-specific regulations, e.g. as

- Electronic waste,
- Batteries and rechargeable batteries.
- Plastics.
- Metals.

Engage a certified disposal company to handle scrapping as needed.

Information on service and maintenance of your device can be found in chapter „16. Service and maintenance“ on page 108.

2. Safety

The chapter on Safety contains information which must be observed to ensure your personal safety and avoid material damage.

2.1 Display of warning notices and safety information

The warning notices shown below

- are found throughout all of the documentation,
- can be found on the devices themselves,
- indicate potential risks and hazards,
- underscore aspects of the information provided that clarifies or simplifies procedures.



The additional symbol on the device itself indicates an electrical danger that can result in serious injuries or death.



This general warning symbol draws attention to a possible risk of injury. Be certain to observe all of the information listed under this symbol in order to avoid possible injury or even death.



2.2 Hazard levels

Warning and safety information is marked by a warning symbol, and the hazard levels are shown as follows, depending on the degree of hazard:

DANGER

Warns of an imminent danger which, if not avoided, results in serious or fatal injury.

WARNING

Warns of a potentially hazardous situation which, if not avoided, could result in serious injury or death.

CAUTION

Warns of an immediately hazardous situation which, if not avoided, can result in minor or moderate injury.

ATTENTION

Warns of an immediately hazardous situation which, if not avoided, can result in material or environmental damage.

INFORMATION

Indicates procedures in which there is **no** hazard of personal injury or material damage.

2.3 Product safety

The device reflects current engineering practice and accepted safety standards, but hazards can arise nonetheless.

Observe the safety regulations and warning notices. If notices are disregarded, this can lead to personal injury and/or damage to the product.

Every type of tampering with or use of this device,

- which goes beyond the mechanical, electrical or other operating limits can lead to personal injury and/or damage to the product;
- constitutes “misuse” and/or “negligence” under the product’s warranty and thus voids the warranty for any possible resulting damage.

Read and understand the user manual before installing, operating, maintaining and using the device.

Only operate the device when in perfect condition and in compliance with this user manual and the usage information that is included. Send defective devices back to the manufacturer in compliance with proper transport conditions.

Retain the user manual throughout the service life of the device and keep it at hand for consultation.

When using the device, also observe the legal and safety regulations for your system that are applicable for the respective use case.

2.4 Dangers when handling the device

When operating electric devices, it is unavoidable for certain parts of these devices to conduct hazardous voltage. Consequently, severe bodily injury or material damage can occur if they are not handled properly.

Therefore, when handling our devices, always observe the following:

- do not exceed the limit values specified in the user manual and on the rating plate! This must also be observed during testing and commissioning!
- Take note of the safety and warning notices in all usage information that belongs to the device!

WARNING

Risk of injury due to electrical voltage!

Severe bodily injury or death can result! Therefore please abide by the following:

- Switch off your installation before commencing work! Secure it against being switched on! Check to be sure it is de-energized! Ground and short circuit! Cover or block off adjacent live parts!
- During operation and troubleshooting (especially for DIN rail devices), check your system for dangerous voltages and switch these off if necessary!
- Wear protective clothing and protective equipment in accordance with applicable guidelines when working on electrical systems!
- Before making connections to the device/the component, ground the device by means of the ground wire connection, if present.
- Do not touching bare or stripped leads that are energized! Equip stranded conductors with wire ferrules!
- Hazardous voltages can be present in all circuitry parts that are connected to the power supply.
- Protect wires, cables and devices with a suitable line circuit breaker/fuse!
- Never switch off, remove or tamper with safety devices!
- There can still be hazardous voltages present in the device or in the component even after it has been disconnected from the supply voltage (capacitor storage).
- Do not operate equipment with current transformer circuits when open.
- Only connect screw terminals with the same number of poles and design!
- Do not exceed the limit values specified in the user manual and on the rating plate! This must also be observed during testing and commissioning.
- Take note of the safety and warning notices in the documents that belong to the device!

2.5 Electrically qualified personnel

To avoid bodily injury and material damage, only electrically qualified personnel are permitted to work on the devices and their components, modules, assemblies, systems and current circuits who have knowledge of:

- the national and international accident prevention regulations,
- safety technology standards,
- installation, commissioning, operation, disconnection, grounding and marking of electrical equipment,
- the requirements concerning personal protective equipment.

Electrically qualified persons within the scope of the technical safety information of all usage information associated with the device and its components are persons who can furnish proof of qualification as an electrically skilled person.

WARNING

Warning against unauthorized manipulation or improper use of the device or its components!

Opening, dismantling or unauthorized manipulation of the device and its components which goes beyond the mechanical, electrical or other operating limits indicated can lead to material damage or injury, up to and including death.

- Only electrically qualified personnel are permitted to work on the devices and their components, assemblies, systems and current circuits.
- Always use your device or component only in the manner described in the associated documentation.
- If there is discernible damage, send the device or the component back to the manufacturer!

2.6 Warranty in the event of damage

Any unauthorized tampering with or use of the device constitutes “misuse” and/or “negligence” under the product’s warranty and thus voids the warranty of any possible resulting damage. In this regard, please take note of section “3.3 Intended use” on page 12.

2.7 Safety information for handling current transformers and measurement devices with residual current measurement

WARNING

Risk of injury due to large currents and high electrical voltage on the current transformers!

Current transformers operated while open on the secondary side (high voltage peaks pose a hazard when touched) can result in severe bodily injury or death.

- Avoid operating the current transformers while open; short circuit the unloaded transformers!
- Before interrupting the current supply, short circuit the secondary connections of the current transformers. Switch any test switches that automatically short circuit the secondary lines of the current transformers to the “Test” status (Check the test switch/short circuiting connection beforehand)!
- Only use current transformers with basic insulation to IEC 61010-1:2010!
- Caution, even current transformers rated as safe for open operation can pose a hazard when touched during operation while open!
- Make sure to mount screw terminals for the current transformer connection on the meter and, if necessary, fasten them with the enclosed screws!
- Comply with the information and provisions in the documentation of your current transformers!

CAUTION

Risk of injury or damage to the meter due to high measurement currents at the connections of the current transformers!

High measurement currents can cause temperatures of up to 80 °C (176 °F) on the connections of the current transformers

- Use wiring that is designed for an operating temperature of at least 80 °C (176 °F)!
- The current transformers can be hot even after the power supply has been switched off. Allow the connections of the current transformers and the connecting cables to cool down before touching them!

WARNING

Risk of injury or damage to the meter due to improper use!

Meters with residual current measurement can trigger warning pulses if limit values are exceeded, and these are used exclusively for monitoring residual currents or failure monitoring. Use of the warning pulses as a stand-alone protective device against electrical shock can lead to injury and even death!

- Do not use devices with residual current measurement as a stand-alone protective device. Employ suitable protective devices for your system!

 **CAUTION****Risk of injury or damage to the meter/your system due to short circuit!**

Inadequate insulation of the operating equipment at the residual current measuring input with respect to the supply circuits can cause voltages at the measuring input which represent a hazard when touched or damage to your device or system.

- Ensure reinforced or double insulation with respect to the supply circuits!
- Ensure galvanic isolation of the residual current measuring inputs from each other!

2.8 Handling batteries/accumulators

The following apply for the battery used in the device:

 **CAUTION****Risk of injury due to fire or burns!**

The battery used in the device may cause fire or burns if used improperly.

- Only replace the battery with the same type or types recommended by Janitza!
- Observe the polarity when installing the battery!
- Remove batteries only with non-conductive tools (e.g. plastic tweezers)!
- Do not recharge, disassemble, burn or heat batteries above 100 °C (212 °F)!
- Do not dispose of batteries with household waste! Follow the disposal instructions in the respective device documentation!
- Keep batteries away from children and animals!
- In case of damage, return devices with a soldered battery to the manufacturer, observing proper transport conditions!

3. Product description

3.1 Device description

The measurement device is a multifunctional network analyzer and is suitable for:

- Measurements and calculations of electrical quantities such as voltage, current, power, energy, harmonics current in building installations, on distribution boards, circuit breakers and busbar trunking systems.
- Measurements of voltages and currents from the same network.
- Measurements in low-voltage networks in which nominal voltages of up to 417 V from conductors to ground and surge voltages of overvoltage category III occur.
- Measurements in medium and high voltage networks via current and voltage transformers. Measurements in medium and high voltage networks are made via current and voltage transformers!
- Current measurement via external $\dots/1$ A or $\dots/5$ A current transformers
- Installation in stationary switchboard cabinets or small distribution boards, in any mounting orientation.
- Use in residential and industrial areas.
- A modular extension of the range of functions with RCM modules (for the range of functions, see the user manual for the modules).

Measurement results are displayed by the measurement device and can be read and processed via interfaces.

INFORMATION

The measurement device is available in variants for TN/TT grid systems and TN/TT/IT grid systems (for differences, see chapter „6. Grid systems“ one page 24).

You can distinguish between the UMG 96-PQ-L and the UMG 96-PQ-L in the IT variant by the part number. The part number can be found on the rating plate of your measurement device:

- UMG 96-PQ-L: 5236001/5236002.
- UMG 96-PQ-L (IT variant): 5236005.

CAUTION

Malfunction and damage of the device or risk of injury due to improper connection.

Improperly connected devices can deliver incorrect measured values, damage the device or pose a risk of injury to persons.

Observe the following:

- Measured voltages and currents must originate from the same network.
- Do not use the measurement device for measuring direct current!
- Ground current-conducting switchboards!

3.2 Incoming goods inspection

Safe and trouble-free operation of this device and its components presupposes proper transport, proper storage, set-up and assembly as well as operation and maintenance in addition to compliance with the safety information and warning notices.

Exercise due caution when unpacking and packing the device, do not use force and only use suitable tools.

Before installing the device, please check the following:

- Its flawless mechanical condition by visual inspection.
- The scope of delivery for completeness.

If it can be assumed that safe operation of the device is no longer possible:

- Disconnect the device from operation immediately!
- Secure the device against being switched on again!

It can be assumed that safe operation is no longer possible if the device, for example:

- Has visible damage.
- No longer functions despite an intact power supply.
- Was subjected to extended periods of unfavorable conditions (e.g. storage outside of the permissible climate thresholds without adjustment to the room climate, condensation, etc.) or transport stress (e.g. falling from an elevated position, even without visible external damage, etc.).

3.3 Intended use

The device is:

- Only for use in the industrial sector.
- Intended for installation in switchboard cabinets and small installation distributors.
- Not intended for installation in vehicles! Use of the device in non-stationary equipment constitutes an exceptional environmental condition and is only permissible by special agreement.
- Not intended for installation in environments with harmful oils, acids, gases, vapors, dusts, radiation, etc.
- Designed as an interior meter.

Safe and trouble-free operation of the device requires proper transport, storage, assembly, installation, operation and maintenance.

3.4 Performance characteristics

General

- Front panel installation device with dimensions of 96 x 96 mm (3.78 x 3.78 in).
- Expansion by means of module
- Connection via screw terminals
- Color graphic display 320 x 240 px
- Operation via 6 buttons
- 3 voltage measurement inputs (600 V, CAT III)
- 3 current measurement inputs (via current transformer)
- 3 digital outputs
- 3 digital inputs (configured as pulse counter with simultaneous power calculation)
- 1 analog output (0 - 20 mA)
- Data memory 64 MByte flash
- RS-485 interface (Modbus RTU, slave, up to 115 kbps)
- Clock and battery
- Working temperature range -10 °C (14 °F) to +55 °C (131 °F).

Measurement uncertainty

- Active energy, measurement uncertainty class 0.2S for $\dots/5$ A transformer
- Active energy, measurement uncertainty class 0.5 for $\dots/1$ A transformer
- Reactive energy class 1

Measurement

- Acquisition of more than 800 measured values
- Measurement in TN and TT networks
- Measurement in TN/TT/IT networks (IT variant of the measurement device – part no.: 5236005)
- Measurement in networks with nominal voltages up to L-L 720 V_{rms} and L-N 417 V_{rms} (according to IEC)
- Measuring range, current 0.005 .. 6 A_{rms}
- True effective value measurement (TRMS)
- Continuous sampling of the voltage and current measurement inputs
- Frequency range of the fundamental oscillation 45 Hz .. 65 Hz
- Measurement of harmonics current, 1st to 65th for U_{LN} and I
- U_{LN}, U_{LL}, I, P (consumption/delivered), Q (ind./cap.)
- 2 tariffs (switching via Modbus or digital input 1)

3.5 EU conformity declaration

Please see the EU declaration of conformity posted at www.janitza.de for the laws, standards and directives applied by Janitza electronics GmbH for the devices. The CE conformity marking requirements for the device arise from the EU conformity declaration and the laws, standards and directives mentioned therein.

3.6 FCC Declaration of Conformity



The device:

- complies with Part 15 of the FCC Rules for Class B digital devices (limits to protect against harmful interference in a residential installation).
- generates, uses and can radiate high-frequency energy
- can cause harmful interference to radio communications if not installed and used properly. There is no guarantee that interference will not occur in a particular installation.

If there is radio or television reception interference, which can be determined by turning the device on and off, proceed as follows:

- Align or reposition the receiving antenna.
- Increase the distance between the device and the radio/television receiver.
- Connect the device and the radio/television receiver in different circuits.
- if necessary, contact Janitza support or a radio/television technician.

Code of Federal Regulations, Title 47, Part 15, Subpart B - Unintentional Radiators.

3.7 Scope of delivery

Quantity	Part. no.	Designation
1	52.32.xxx ¹⁾	UMG 96-PQ-L / UMG 96-PQ-L (IT variant)
1	33.03.389	Installation instructions
1	33.03.342	Supplement "Safety Information"
1	33.03.361	"GridVis Software" Quick Guide
1	10.01.896	Screw terminal, pluggable, 3-pole (auxiliary supply)
1	10.01.849	Screw terminal, pluggable, 4-pole (voltage measurement)
1	10.01.871	Screw terminal, pluggable, 6-pole (current measurement)
1	10.01.909	Screw terminal, pluggable, 3-pole (RS-485)
1	10.01.865	Screw terminal, plug-in, 10-pole (digital inputs/outputs, analog output)
1	52.22.251	Mounting kit

1) For part number see delivery note
Tab. Scope of delivery

3.8 Accessories

Quantity	Part. no.	Designation
1	21.01.058	Battery type, lithium CR2032, 3 V (approval according to UL 1642)
1	29.01.065	Silicone seal, 96 x 96
1	15.06.015	Interface converter RS-485 <-> RS-232
1	15.06.107	Interface converter RS-485 <-> USB

INFORMATION

- All supplied options and design variants are described on the delivery note.

The following apply for the battery used in the device: **3.12 GridVis® network analysis software**

 CAUTION
<p>Risk of injury due to fire or burns! The battery used in the device may cause fire or burns if used improperly.</p> <ul style="list-style-type: none"> · Only replace the battery with the same type or types recommended by Janitza! · Observe the polarity when installing the battery! · Remove batteries only with non-conductive tools (e.g. plastic tweezers)! · Do not recharge, disassemble, burn or heat batteries above 100 °C (212 °F)! · Do not dispose of batteries with household waste! Follow the disposal instructions in the respective device documentation! · Keep batteries away from children and animals! · In case of damage, return devices with a soldered battery to the manufacturer, observing proper transport conditions!

3.9 Measuring method

The device measures

- Continuously and calculates all effective values using in a 200 ms interval.
- The true RMS value (TRMS) of the voltages and currents applied to the measuring inputs.

3.10 Transformer

Please note! It is not permitted to use the outputs of Janitza measurement devices and components for switching protective devices or protective relays! Use only “Current transformers for measuring purposes” for Janitza measurement devices and Janitza components!

3.11 Operating concept

The operating concept of the measurement device incorporates the following methods:

- 6 function buttons with display for configuration and acquisition of data.
- The GridVis network analysis and programming software® for programming and analysis of data.
- The Modbus protocol and the Modbus address list to configure and read out data. The Modbus address list is available at www.janitza.de.

This user manual describes how to operate the measurement device using the 6 function buttons and how to use the Modbus editor. The GridVis® network analysis software has its own “online help” and e-learning tutorials.

The GridVis® software (download at www.janitza.de) is the perfect tool for the configuration, readout and analysis of measurement data.

Performance characteristics of the GridVis® software

- Configure and read out data from your measurement device.
- Graphic display of measured values.
- Store measurement data in databases.
- Analyze measurement data that has been read out.
- Create reports.

Connections to the PC (GridVis® software)

Connections for communication between the PC and the measurement device can be found in chap. „8. Connection and PC connections“ on page 34.

4. Structure of the device

4.1 Front panel - Display and controls

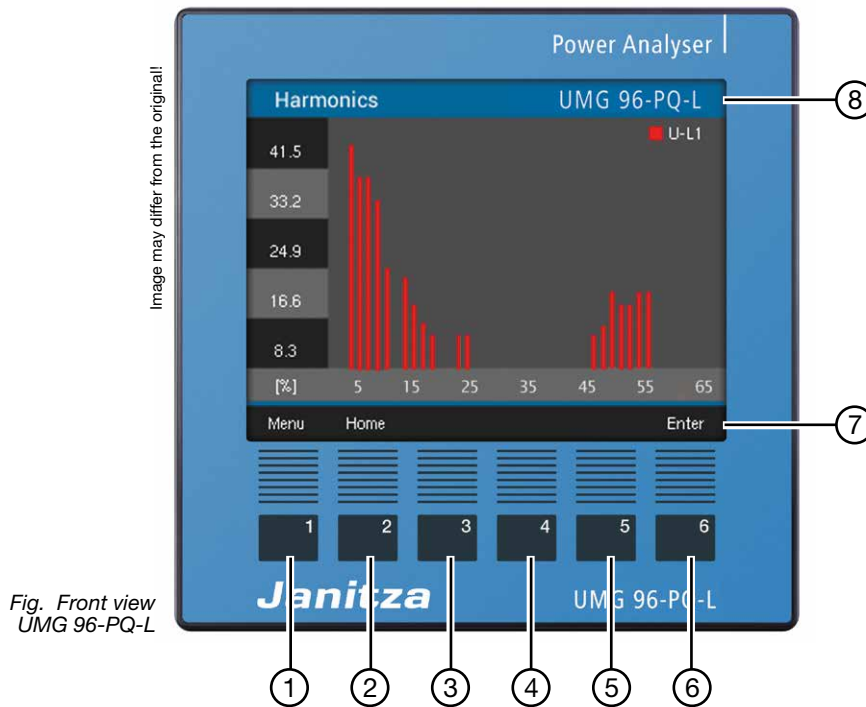

Item	Function/Designation
1	Button 1: · Display Menu · Exit Menu · Cancel action (ESC)
2	Button 2: · Go to the start screen. (Default setting: "Summary" display) · Select position (to the left "◀"). · Configuration of a measuring display as the start screen (press until message appears).
3	Button 3: · Select menu item or position (down "▼"). · Change (selection, number -1).
4	Button 4: · Select menu item or position (up "▲"). · Change (selection, number +1).
5	Button 5: · Select position (to the right "▶").
6	Button 6: · Open selection menu, activate input, confirm selection (Enter).
7	Description of the function buttons
8	Device type

Tab.: Front panel - Display and controls

4.2 Rear of the device - Connections

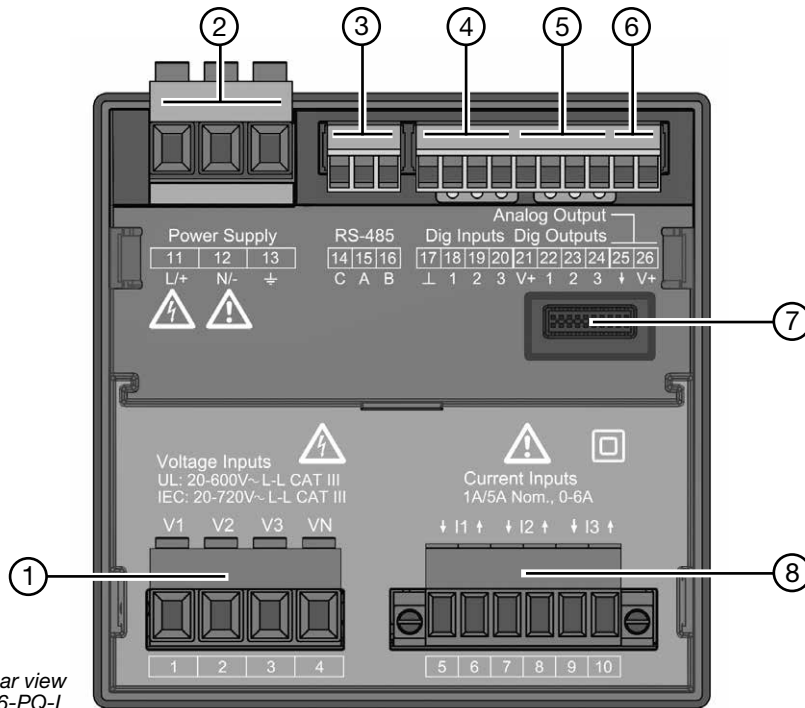

Fig. Rear view
UMG 96-PQ-L

Item	Function/Designation
1	Voltage measurement inputs V ₁ to V ₃ and V _N
2	Supply voltage
3	RS-485 interface
4	Digital inputs
5	Digital outputs
6	Analog outputs
7	Module connector socket
8	Current measurement inputs I ₁ to I ₃

Tab.: Rear of the device - Connections

4.3 Rating plate

UMG 96-PQ-L

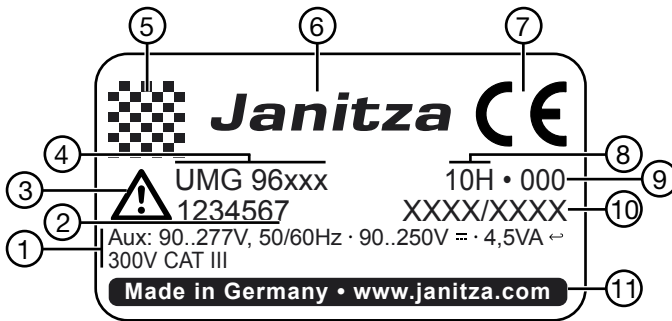

Item	Designation	Description
1	Operational data	<ul style="list-style-type: none"> · Supply voltage, AC in V · Nominal frequency in Hz · Supply voltage, DC in V · Power consumption in VA · Overvoltage category
2	Part number	Manufacturer's part number
3	Symbol for "Danger sign"	General hazard symbol. Be certain to observe the warning notices applied to the device and shown in the documentation in order to avoid possible injury or even death.
4	Device type	Device designation
5	Data matrix code	Coded manufacturer data
6	Manufacturer's logo	Logo of the device manufacturer
7	CE conformity marking	see section „3.5 EU conformity declaration“ on page 18.
8	Manufacturer-specific data	Manufacturer data
9	Hardware version	Hardware version of your device
10	Type/serial number	Number for identification of the device
11	Designation of origin/web address	Country of origin and manufacturer's web address

Tab.: Rating plate

5. Mounting

5.1 Installation location

⚠ DANGER

Danger of electric shock!

Electric shocks lead to serious injuries, including death.

- Disconnect your system from the power supply before mounting and connecting the device!
- Secure it against being switched on!
- Check to be sure it is de-energized!
- Ground and short circuit!
- Cover or block off adjacent live parts!
- The installation must only be carried out by qualified personnel with electrical training!

The measurement device is suitable for installation in stationary and weather-protected indoor switchboards. Ground conductive switchboards!

ATTENTION

Material damage due to disregard of the installation instructions!

Disregard of the installation instructions can damage or destroy your device.

- Observe the information on the mounting orientation in the sections "Mounting" and "Technical Data".
- Provide adequate air circulation in your installation environment and, as needed, cooling when the temperatures are high!

5.2 Mounting orientation

The cut-out dimension in the switchboard is $92^{+0.8}$ mm x $92^{+0.8}$ mm ($3.62^{+0.03}$ in x $3.62^{+0.03}$ in).

Minimum clearances for adequate ventilation:

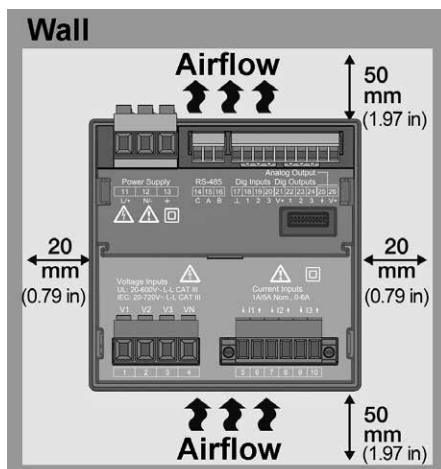
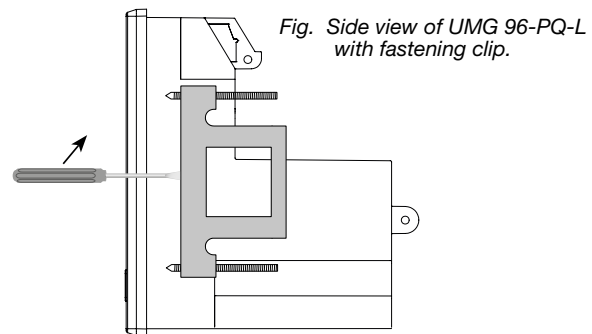

Fig. Mounting orientation of the UMG 96-PQ-L (rear view)

5.3 Securing

Secure the device inside the switchboard (mounting plate) with the fastening clips on the side. To do so, proceed as follows:

- Before inserting the device, remove the fastening clips (e.g. with a screwdriver) by levering them horizontally.



- Guide the device through the switchboard (mounting plate) from the front.
- Attach the clips to the side of the device by pushing them in and snapping them into place.
- Screw in the clamping screws until they touch the mounting plate.
- Then tighten the clamping screws with two further turns each. Too tightly tightened clamping screws can destroy the fastening clips!

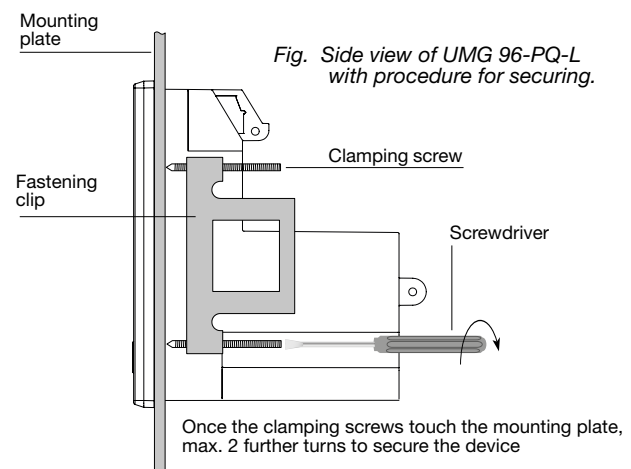

6. Grid systems

Grid systems and maximum rated voltages according to DIN EN 61010-1/A1:

UMG 96-PQ-L and UMG 96-PQ-L (IT variant)			
Three-phase 4-conductor systems with grounded neutral conductor		Three-phase 3-conductor systems with grounded phase	
IEC	$U_{L-N} / U_{L-L}: 417 V_{LN} / 720 V_{LL}$	IEC	$U_{L-L}: 600 V_{LL}$
UL	$U_{L-N} / U_{L-L}: 347 V_{LN} / 600 V_{LL}$	UL	$U_{L-L}: 600 V_{LL}$

UMG 96-PQ-L (IT variant)			
Three-phase 4-conductor systems with non-grounded neutral conductor (IT networks)		Three-phase 3-conductor systems ungrounded	
IEC	$U_{L-N} / U_{L-L}: 347 V_{LN} / 600 V_{LL}$	IEC	$U_{L-L}: 600 V_{LL}$
UL	$U_{L-N} / U_{L-L}: 347 V_{LN} / 600 V_{LL}$	UL	$U_{L-L}: 600 V_{LL}$

The measurement device can be used in:

- TN and TT networks.
- IT networks (IT variant - part number: 5236005).
- Residential and industrial areas.

WARNING

Risk of injury due to electrical voltage!

Rated surge voltages above the permitted over-voltage category can damage the insulation in the device. This impairs the safety of the device. This can result in serious injury or death.

- Only use the device in environments which comply with the permissible rated surge voltage.
- Observe the limit values specified in the user manual and on the rating plate.

INFORMATION

You can distinguish between the UMG 96-PQ-L and the UMG 96-PQ-L in the IT variant by the part number. The part number can be found on the rating plate of your measurement device:

- UMG 96-PQ-L: 5236001/5236002.
- UMG 96-PQ-L (IT variant): 5236005.

7. Installation

Use the measurement device for voltage measurement in TN and TT grid systems or the IT variant measurement device with the approved overvoltage category of 600V CATIII (rated surge voltage 6 kV).

WARNING

Risk of injury due to electrical voltage!

Do not short-circuit secondary connections of voltage transformers! This can result in serious injury or death.

- Connect voltage transformers according to their documentation!
- Check your installation!

WARNING

Disregard of the connection conditions of the transformers to Janitza measurement devices or their components can lead to injuries or even death or to material damage!

- Do not use the outputs of the Janitza measurement devices or their components for switching protective devices or protective relays! Do not use "Transformers for protection purposes"!
- For Janitza measurement devices and their components use only "Transformers for measurement purposes" which are suitable for the energy monitoring of your system.
- Observe the information, regulations and limit values in the use information on "Transformers for measuring purposes", specifically during testing and commissioning of the Janitza measurement device, the Janitza component and your system.

7.1 Nominal voltages

7.1.1 Three-phase four-conductor network with grounded neutral conductor

Networks and nominal voltages suitable for your measurement device:

U_{L-N} / U_{L-L}	
66 V / 115 V	
120 V / 208 V	
127 V / 220 V	
220 V / 380 V	
230 V / 400 V	
240 V / 415 V	
260 V / 440 V	
277 V / 480 V	Maximum nominal voltage of the network according to UL
347 V / 600 V	
400 V / 690 V	
417 V / 720 V	Maximum nominal voltage of the network

Fig. Nominal network voltages suitable for measuring inputs according to EN 60664-1:2003 (valid in three-phase 4-conductor systems with grounded neutral conductor - see chapter "Grid systems").

INFORMATION

Please take special note of the maximum nominal voltages of the **Measurement device in the IT variant** for three-phase 4-wire systems with a **non-grounded neutral conductor (IT networks)** - **For details see chapter „6. Grid systems“ one page 24.**

INFORMATION

The device optionally allows the connection of 100 V voltage transformers!

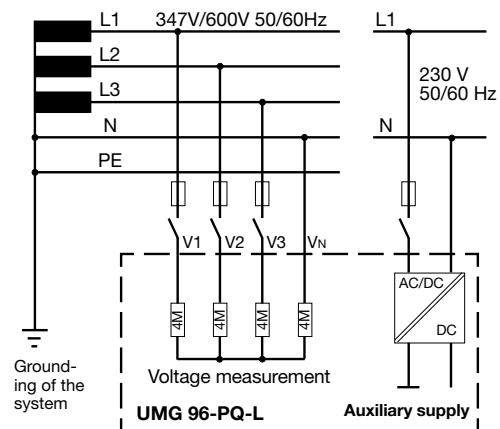

Fig. Example, schematic diagram (UMG 96-PQ-L) - Measurement in three-phase 4-conductor systems.

7.3.1 Three-phase three-conductor system

Networks and nominal voltages suitable for your device:

U _{L-L}
100 V
120 V
200 V
240 V
347 V
380 V
400 V
415 V
440 V
480 V
600 V

Maximum nominal voltage of the network according to IEC and UL

Fig. Nominal network voltages suitable for measuring inputs according to EN 60664-1:2003 (valid in three-phase 3-conductor systems - see chapter "Grid systems").

7.2 Disconnect switch

Install a suitable circuit breaker for the supply voltage in the building installation in order to disconnect the device from voltage and current.

- Install the circuit breaker near the device and within reach of the user.
- Mark the circuit breaker as the isolation device for this piece of equipment.

7.3 Supply voltage

 WARNING
<p>Risk of injury due to electrical voltage! Severe bodily injury or death can result from:</p> <ul style="list-style-type: none"> · Touching bare or stripped leads that are energized. · Device inputs that pose a hazard when touched. · Disconnect your system from the power supply before mounting and connecting the device! · Secure it against being switched on! · Check to be sure it is de-energized! · Ground and short circuit! · Cover or block off adjacent live parts!

Operation of the device requires a supply voltage. The type and level of the supply voltage for your device can be found on the rating plate. Also note:

- Before applying the supply voltage, ensure that the voltage and frequency match the specifications on the rating plate.
- Connect the supply voltage via a UL/IEC approved fuse to the plug-in terminals on the rear of the device.
- After connecting the supply voltage, the display appears.

INFORMATION

Note that the device requires an initialization phase (boot time) at startup!

If no display appears, check:

- The connection of your device.
- The supply voltage.

 WARNING
<p>Risk of injury due to electrical voltage! Severe bodily injury or death can result from:</p> <ul style="list-style-type: none"> · Touching bare or stripped leads that are energized. · Device inputs that pose a hazard when touched. <p>Switch off your installation before commencing work! Secure it against being switched on! Check to be sure it is de-energized! Ground and short circuit! Cover or block off adjacent live parts!</p>

 CAUTION
<p>Material damage due to disregard of the connection instructions! Disregard of the connection instructions can damage or destroy your device.</p> <p>Therefore please abide by the following:</p> <ul style="list-style-type: none"> · Observe the voltage and frequency specifications on the rating plate! · Connect the supply voltage via a fuse according to the technical data! · Do not tap the supply voltage from the voltage transformers! · Provide a fuse for the neutral conductor if the neutral conductor terminal of the source is not grounded!

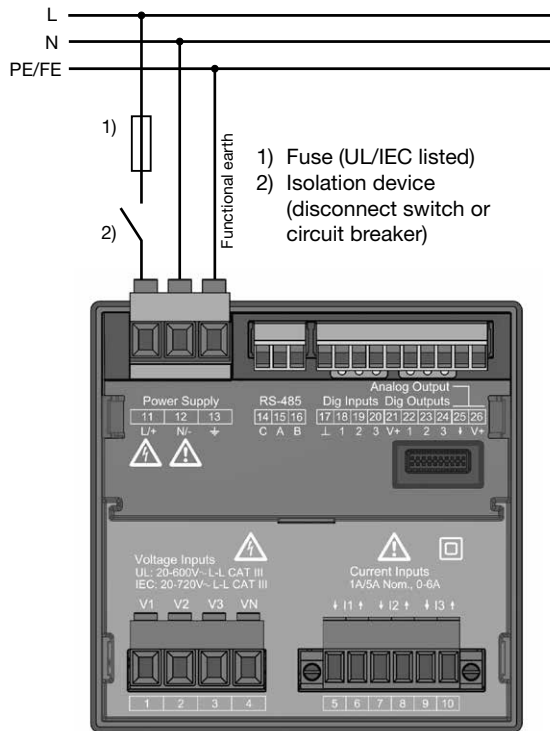

Fig. "Supply voltage" connection example

Overcurrent protective device for the line protection of the supply voltage

Recommendation for the overcurrent protective device of the supply voltage line protection (dependent on the device variants):

- Option 230 V --> 6 - 16 A (Char. B)
- Option 24 V * --> 1 - 6 A (Char. B)

i INFORMATION

The fuse is a line protection, **not** a device protection!

i INFORMATION

Without a functional earth, the device indicates a residual voltage that is not applied.

7.4 Voltage measurement

There are 3 voltage measurement inputs (V1 to V3) on the rear of the device.

7.4.1 Overvoltage

The voltage measurement inputs are suitable for measurement in networks where overvoltages of category 600 V CAT III (rated surge voltage 6 kV) can occur.

7.4.2 Frequency

The device:

- Requires the mains frequency for the measurement and calculation of measured values.
- Is suitable for measurement in networks in which the fundamental oscillation of the voltage is in the range from 45 Hz to 65 Hz.

The mains frequency is determined from the measured voltage of phase L1. The sampling frequency of the voltage and current measurement inputs results from the mains frequency.

When measuring with strongly distorted voltages, the frequency of the voltage fundamental oscillation can no longer be determined exactly. This means that for strongly distorted measured voltages, the corresponding mains frequency should have a fixed specification. Voltage distortions occur, for example, during measurements on consumers that are operated with phase-angle control. Distortions of the current do not influence the frequency determination.

Further information can be found in the section „12.4.4 Nominal frequency“ on page 49.

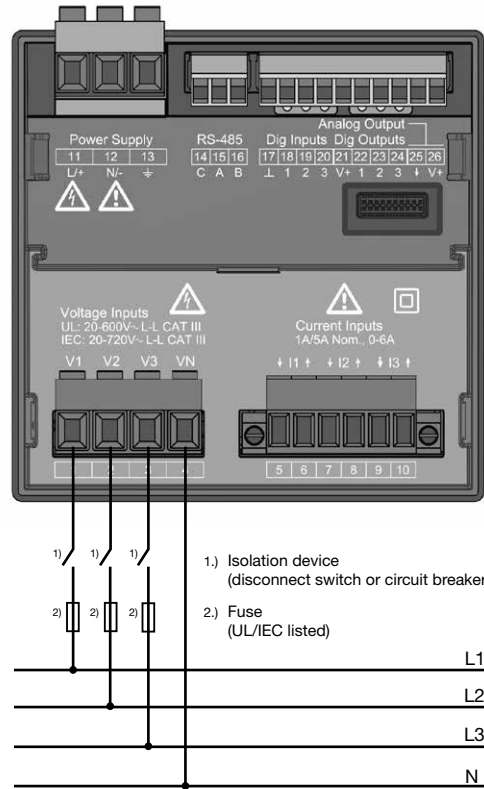

Fig. Connection example for voltage measurement.

WARNING

Risk of injury due to electrical voltage! Serious bodily injury or death can result from failure to observe the connection conditions for the voltage measurement inputs.

Therefore please abide by the following:

- **Switch off your installation before commencing work! Check to be sure it is de-energized!**
- **Connect voltages above the permitted nominal network voltages via voltage transformers.**
- **The voltage measurement inputs on the device are dangerous to touch!**
- **Install a circuit breaker (see section 7.2 on page 26).**
- Use a UL/IEC approved overcurrent protective device with a nominal value rated for the short circuit current at the connection point.

CAUTION

Malfunction due to improper connection.

Improper connection of the device can result in incorrect measured values.

Therefore please abide by the following:

- Measured voltages and currents must originate from the same network.
- The device is not suitable for measuring DC voltage.

i INFORMATION

- The device only determines measured values if a voltage L1-N of greater than 20 V_{eff} (4-conductor measurement) or a voltage L1-L2 of greater than 34 V_{eff} (3-conductor measurement) is applied to voltage measurement input V1.
- Use a line protection (1-10 A) with IEC/UL approval as an overcurrent protective device for voltage measurement.

7.4.3 Connection variants for voltage measurement

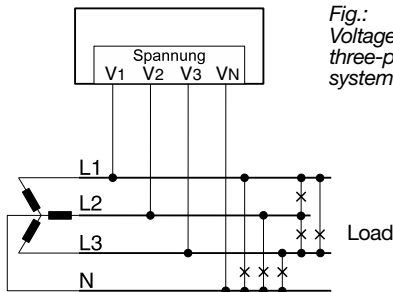

Fig.: Voltage measurement in three-phase 4-conductor system

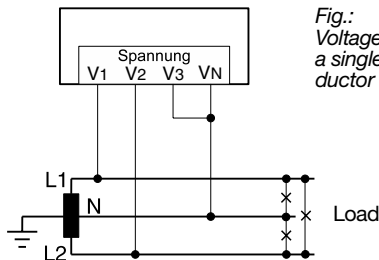

Fig.: Voltage measurement in a single-phase 3-conductor system.

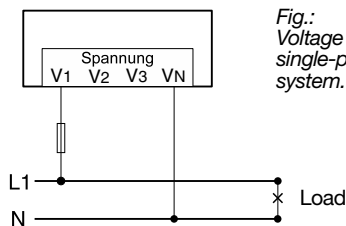

Fig.: Voltage measurement in a single-phase 2-conductor system.

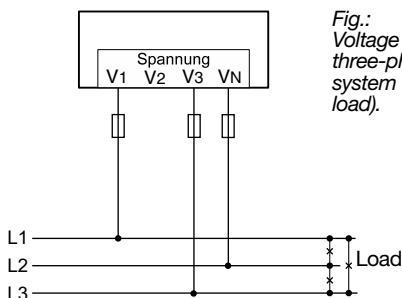

Fig.: Voltage measurement in a three-phase 3-conductor system (asymmetrical load).

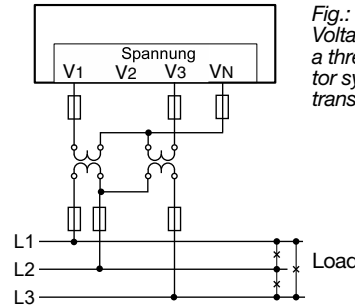

Fig.: Voltage measurement in a three-phase 3-conductor system with voltage transformer.

The measurement device is suitable for TN, TT and IT networks (IT variant)!

i INFORMATION

The device only allows the setting of **one voltage transformer ratio for all phases!**

The **voltage transformer ratios** can be conveniently configured via:

- The device menu.
- The GridVis® software.

For information on voltage transformer configuration, see the section „12.4.1 Current and voltage transformers“ on page 46.

For information on overrange, see the section „13.7 Overage“ on page 61.

Connection variant “Voltage measurement with functional earthing (FE)”

For a measurement in a grounded 3-phase system without N, connect the PE as a functional earth (FE) to the voltage measurement input V_N of the device. Make sure to use the color “pink” (DIN EN 60445/VDE 0197) for the functional earth conductor and to observe the limits for the voltage measurement.

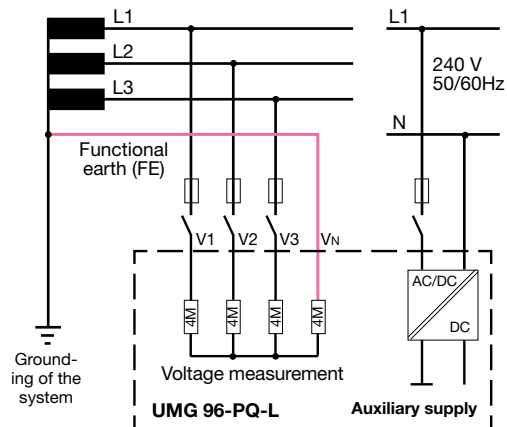

Fig. Connection variant - Voltage measurement in a grounded 3-phase system.

Do not use the protective earthing present in your system as functional a earthing!

7.5 Current measurement

The device:

- Is designed for the connection of current transformers with secondary currents of $\dots/1$ A and $\dots/5$ A.
- Is only approved for current measurement via current transformers.
- Does not measure DC currents.

The factory-set current transformer ratio is 5/5 A and must be adapted to the current transformers used as needed.

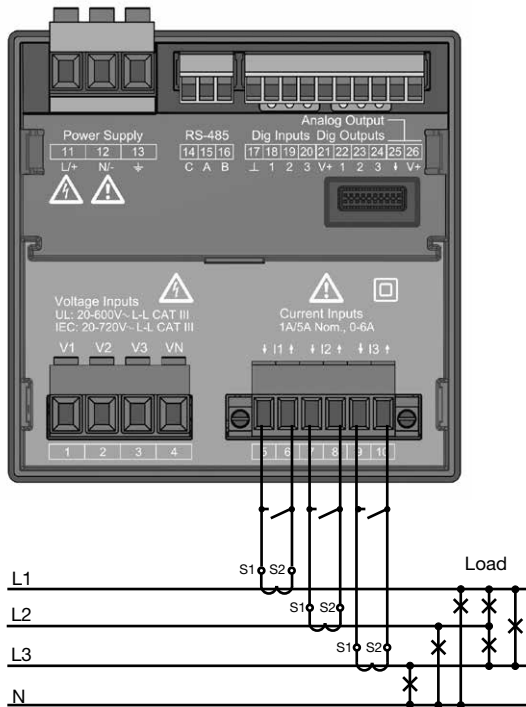

Fig. Connection example, "Current measurement via current transformer".

! WARNING

Risk of injury due to electrical voltage at current transformers!

Current transformers which are operated exposed on the secondary side can carry hazardous live high voltage peaks which can lead to serious bodily injury or death.

Therefore please abide by the following:

- Switch off your installation before commencing work! Check to be sure it is de-energized!
- Avoid exposed operation of the current transformers.
- Short circuit unloaded current transformers.
- Before interrupting the supply of power, it is essential to short the secondary connections of the current transformers.
- If there is a test switch which automatically short-circuits the secondary current transformer lines, it is sufficient to set it to the "Test" position, provided that the short-circuiters have been checked beforehand.
- Only use current transformers with basic insulation according to IEC 61010-1:2010.
- Make sure to mount the screw terminals for the current transformer connection, which are included in the scope of delivery, on the meter and fasten them with the enclosed screws!
- Even current transformers rated as safe for exposed operation are dangerous to touch if they are operated exposed.
- Observe the documentation for the current transformers!

! WARNING

Risk of injury due to electrical voltage!

At high measuring currents, temperatures of up to 80 °C (176 °F) can occur at the connections.

Use wiring that is designed for an operating temperature of at least 80 °C (176 °F)!

! WARNING

Risk of injury due to electrical voltage!

Severe bodily injury or death can result from:

- Touching bare or stripped leads that are energized.
- Device inputs that pose a hazard when touched.

Disconnect your system from the power supply before starting work! Check to be sure there is no voltage! Ground the system!

Use the ground connection points with the ground symbol to do so!

i INFORMATION

The device only allows the setting of **one current transformer ratio for all phases!**

You can configure **current transformer ratios** conveniently via

- The device menu.
- The GridVis® software.

For information on current transformer configuration, see the section „12.4.1 Current and voltage transformers“ on page 46.

7.5.1 Current direction

You can correct the current direction for each phase individually via the serial interfaces provided. This means that in the case of incorrect connection, no subsequent reconnection of the current transformers is necessary.

7.5.2 Summation current measurement

For a summation current measurement via two current transformers, first set their total ratio on the device. The setting of the current transformer ratios is described in section 12.4.1 on page 46.

Example:

The current is measured via two current transformers. Both current transformers have a ratio of 1000/5 A. The summation measurement is carried out with a summation current transformer of 5+5/5 A.

The device must then be adjusted as follows:

Primary current: 1000 A + 1000 A = 2000 A

Secondary current: 5 A

7.5.3 Ammeter

If you want to measure the current not only with the UMG, but also with an ammeter, connect the ammeter to the UMG in series.

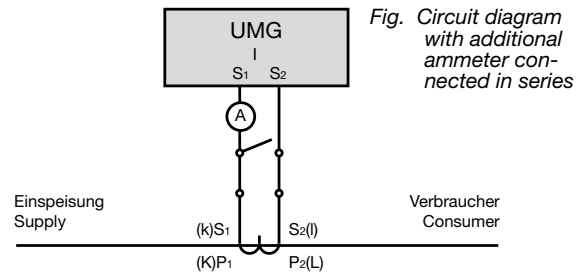
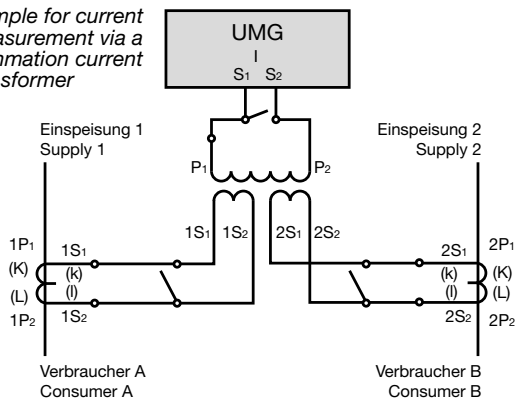
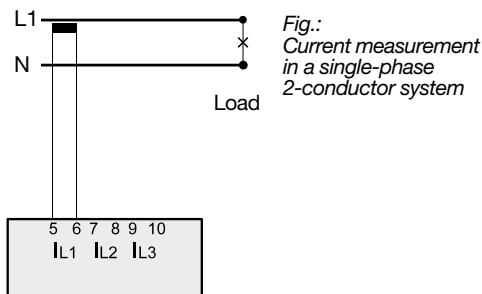
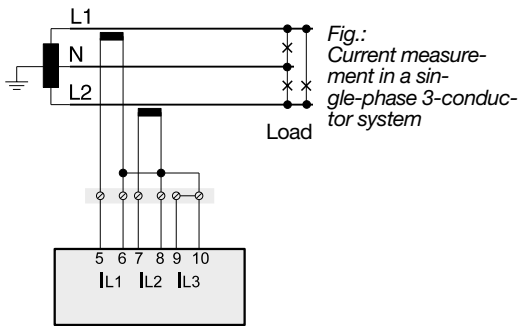
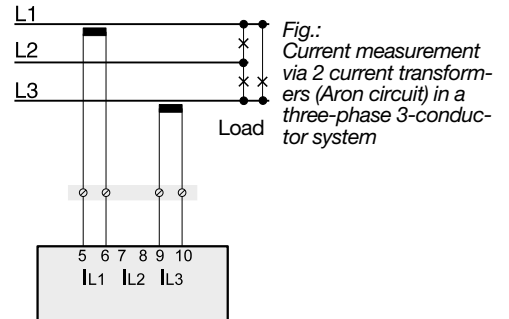
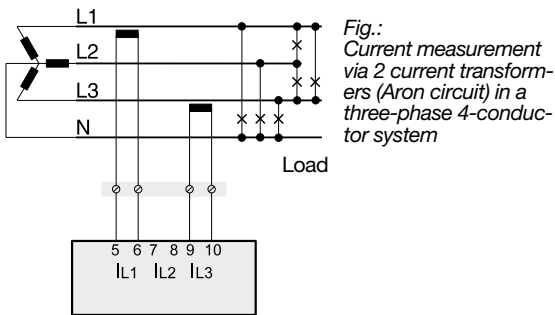
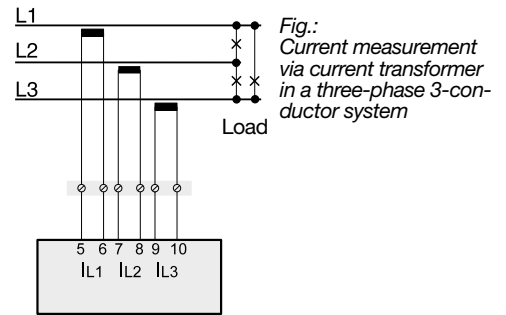
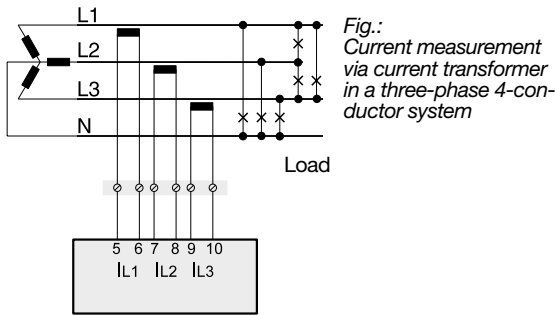

Fig. Example for current measurement via a summation current transformer



7.5.4 Connection variants for current measurement



i INFORMATION

You can configure current transformer ratios

- The device menu.
- The GridVis® software.

See section „12.4.1 Current and voltage transformers“ on page 46.

If the measuring range is exceeded, the device display shows the warning **Overrange with specification of the current or voltage circuit.**

For information on overrange, see the section „13.7 Overrange“ on page 61.

8. Connection and PC connections

8.1 Connection variants

When connecting the device to a PC, there are several possibilities:

1. Connection via an interface converter:

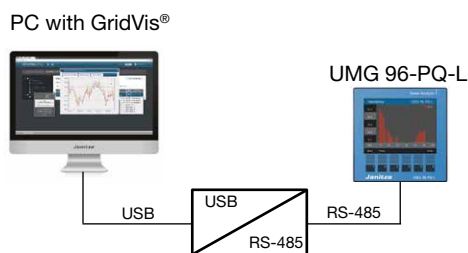
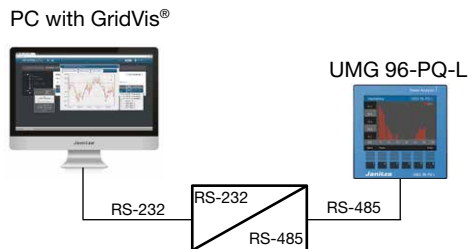

1. Use of the UMG 96-PQ-L (server device) via a UMG with gateway functionality (e.g. UMG 512 client device):

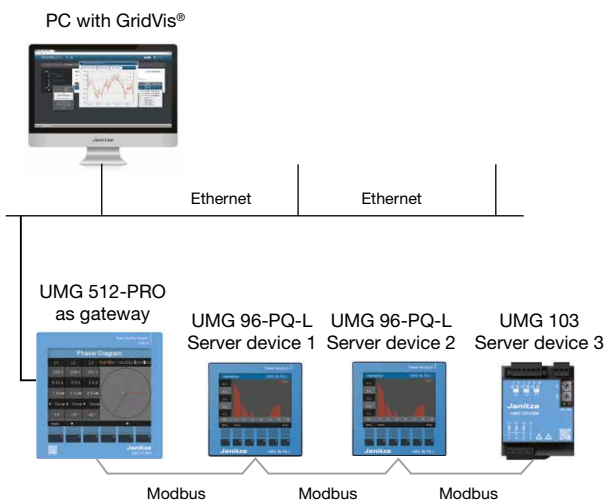

i INFORMATION

- As an option to these connection possibilities, an expansion module for the UMG 96-PQ-L offers an Ethernet interface for communication.
- Information on the Expansion module with Ethernet interface can be found in the usage information on the module.

! CAUTION

Material damage due to incorrect network settings.

Incorrect network settings can cause faults in the IT network.

Ask your network administrator about the correct network settings for your device.

8.2 RS-485 interface

The device communicates with the Modbus RTU protocol via an RS-485 interface (3-pole plug contact).

Recommended cable type:

- Unitronic Li2YCY(TP) 2x2x0.22 (Lapp cable)

Connection capacity of the terminal:

- 0.2 - 1.5 mm²
(see the chapter "Technical Data")

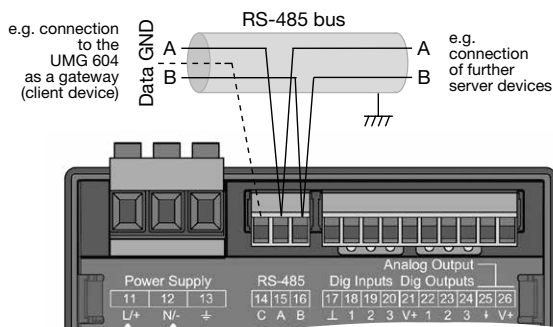

Fig. RS-485 interface, 3-pole plug contact

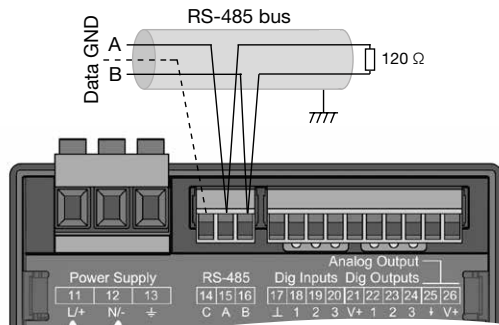

Fig. RS-485 interface, 3-pole plug contact with termination resistor (part no. 52.00.008)

i INFORMATION

- CAT cables are not suitable for bus wiring! Use the recommended cable types (see above).
- A segment of an RS-485 bus structure contains up to 32 nodes/devices. Connect more than 32 nodes/devices with repeaters.
- The device does not contain an integrated termination resistor (see section „8.4 Termination resistors“ on page 36).
- In an RS-485 bus structure, please observe the address settings for your server and client devices in the respective documentation.

8.3 Shielding

Provide a twisted and shielded cable for connections via the interfaces and observe the following points for shielding:

- Ground the shields of all cables leading into the cabinet at the cabinet entrance.
- Connect the shield to a noiseless ground and ensure a large surface area with good conductivity.
- Do NOT connect the shield to terminal C (GND)
- Mechanically restrain the cables before the grounding clamp to prevent damage from cable movement.
- Use suitable cable glands, for example PG glands, to lead the cable into the switchboard cabinet.

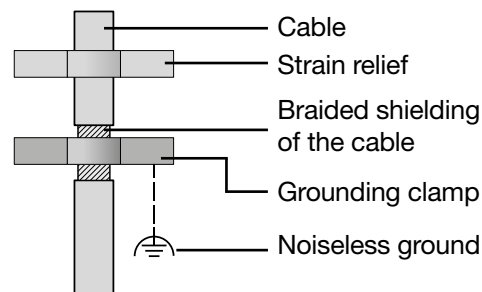

Fig. Shielding design for cabinet entry.

! WARNING

Transmission error and risk of injury due to electrical fault!

Atmospheric discharge can cause transmission errors and hazardous voltages on the device.

Therefore please abide by the following:

- Connect the shielding to functional earth (PE) at least once.
- In the case of larger sources of interference, frequency converters in the switchboard cabinet, connect the shielding to functional earth (PE) as close as possible to the device.
- Observe the maximum cable length of 1200 m (3960 ft.) at a baud rate of 38.4 k.
- Use shielded cables.
- Route interface cables spatially separated or additionally insulated from mains voltage-carrying system components.



8.4 Termination resistors

At the beginning and end of a segment, the cable is to be terminated with resistors (120 Ω, 1/4 W).

i INFORMATION

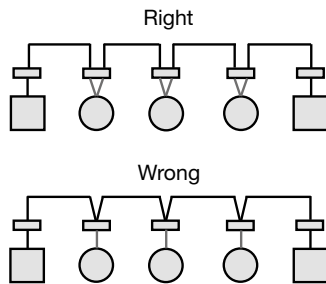
The device does not contain an integrated termination resistor!



	Terminal strip in the switchboard cabinet.
	Device with RS-485 interface. (Without termination resistor)
	Device with RS-485 interface. (With termination resistor on the device)

8.5 Bus structure

In a bus structure:

- Connect all devices in line.
- Each device has its own address.
- One segment contains up to 32 nodes/devices. At the beginning and end of a segment, the cable must be terminated with resistors (bus termination, 120 ohms, 1/4 W)!
- With more than 32 participants, use repeaters (line amplifiers) to connect segments!
- Devices with bus termination switched on must be powered.
- It is recommended that the client device be placed at the end of a segment. If the server device is replaced with the bus termination switched on, the bus is out of operation.
- The bus can become unstable if a server device with bus termination switched on is replaced or is de-energized.
- Devices that are not involved in the bus termination can be replaced without the bus becoming unstable.

Fig. Representation of a bus structure *

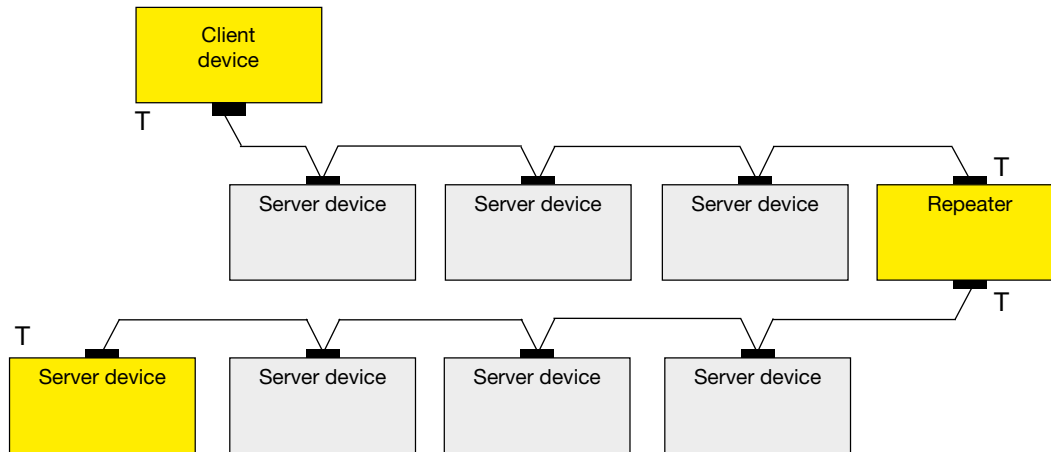

Power supply necessary

Client device - e.g. UMG 604-PRO

T Bus terminator on

Server device - UMG 96PA

* In a **Modbus system** the Modbus organization (modbus.org) uses the terms "client" and "server" to describe Modbus communication, characterized by communication between client devices - formerly master devices - that initiate communication and make requests, and server devices - formerly slave devices - that process the requests and return an appropriate response (or error message).

9. Digital inputs and outputs

The device has:

- 3 digital inputs and
- 3 digital outputs

9.1 Digital inputs

The device has 3 digital inputs for the connection of, for example, one signal generator each. If a signal is present, the corresponding LED lights up green.

The device recognizes an input signal at the digital input if:

- A voltage of at least 18 V and at most 28 V DC (typically at 4 mA) is present.
- A current of at least 0.5 mA and at most 6 mA flows.

Observe the polarity of the supply voltage!

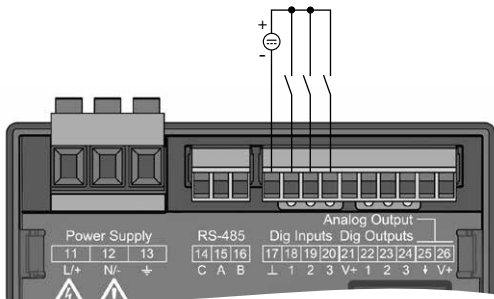

Fig. Connection of digital inputs

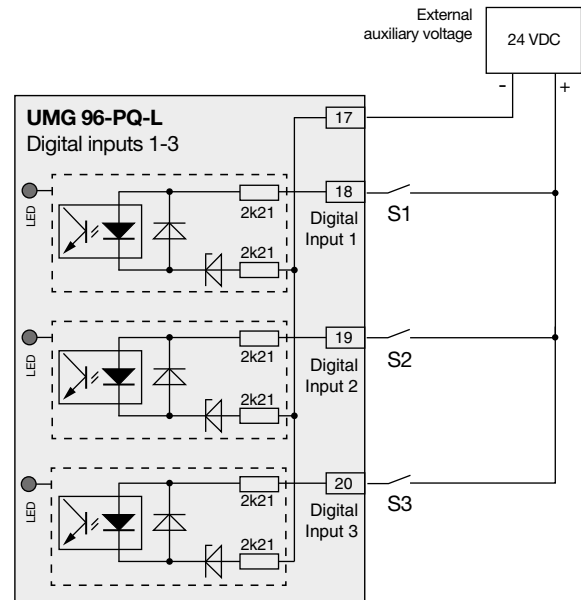

Fig. Example for the connection of the external switching contacts S1-S3 to the digital inputs 1, 2 and 3.

9.1.1 S0 pulse input

Each digital input is designed for the connection of an S0 pulse generator according to DIN EN62053-31.

You need an external auxiliary voltage with an output voltage in the range of 18 .. 28 VDC and a resistor of 1.5 kohms.

⚠ CAUTION

Transmission error and material damage due to electrical malfunction.
 With a cable length of more than 30 m (32.81 yd), there is an increased probability of transmission errors and damage to the device due to atmospheric discharge!
Use shielded cables for the connections to the digital inputs and outputs!

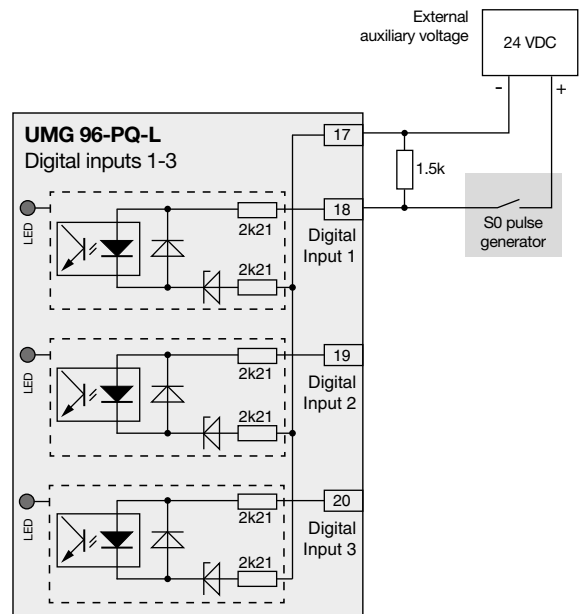

Fig. Example for the connection of an S0 pulse generator to digital input 1.

9.2 Digital outputs

The device has 3 digital outputs, which:

- Are electrically isolated from the evaluation electronics via optocouplers.
- Have a common reference.
- Are not short-circuit proof.
- Require an external auxiliary voltage.
- Can be used as impulse outputs.
- Are able to switch direct and alternating current loads.
- Can be controlled via Modbus.
- Output the results of comparators.

CAUTION

Material damage due to connection errors.

The digital outputs are not short-circuit proof! Connection errors can therefore lead to damage to the connections.

Make sure that the wiring is correct when connecting the outputs.

INFORMATION

- Functions for the digital outputs can be configured easily and clearly in the GridVis® software (see www.janitza.de).
- Use of the GridVis® software requires a connection between the device and the PC via an interface.

CAUTION

Measurement error when used as a pulse output.

When the digital outputs are used as pulse outputs, measurement errors can occur due to residual ripple.

For the supply voltage (DC) of the digital inputs and outputs, use a power supply whose residual ripple is less than 5% of the supply voltage.

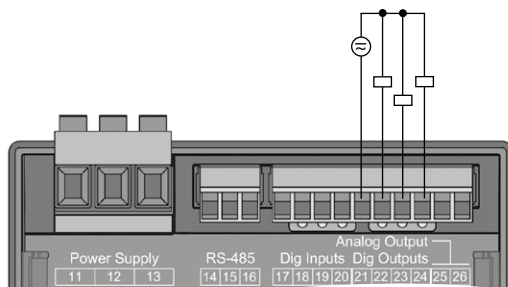

Fig. Connection of digital/pulse outputs

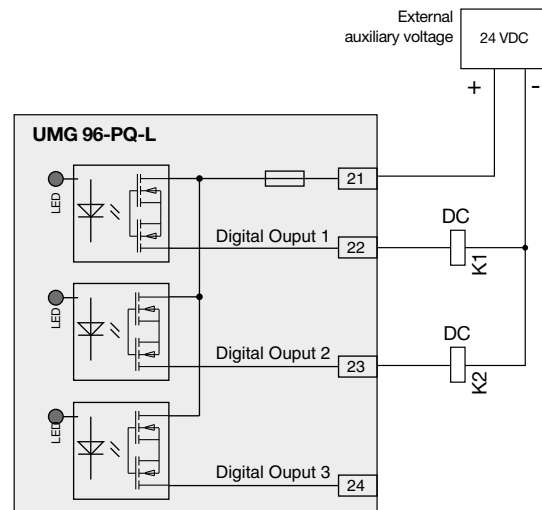

Fig. Connection example of two relays to the digital outputs

9.3 LED status bar

The LED status bar on the back of the device shows the different states of the inputs and outputs.

Digital inputs

The LED assigned to the respective input lights up green if a signal of at least 4 mA is flowing at this interface.

Digital outputs

The respective LED assigned to the output lights up green when the output is set as active - independent of any further connection to this interface.

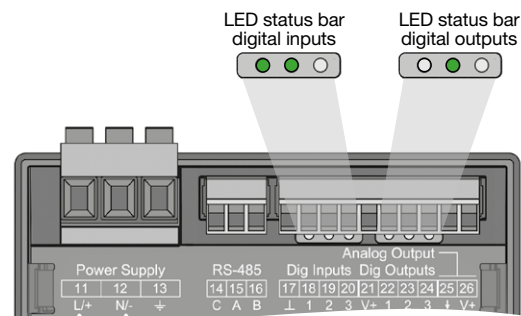

10. Analog outputs

The device has 1 passive analog output which can deliver a current of 0 - 20 mA. An external power supply unit (24 V DC) is required for operation.

The connectable load must not exceed a resistance of 300 ohms.
 If the analog output is loaded with a higher resistance, the output range (20 mA) is restricted.

The measured value assigned to the analog output, the start and end values and the output range 4 - 20 mA or 0 - 20 mA must be set using the GridVis® software (for more information, refer to section „13.15 Configuration of the analog output“ on page 74)

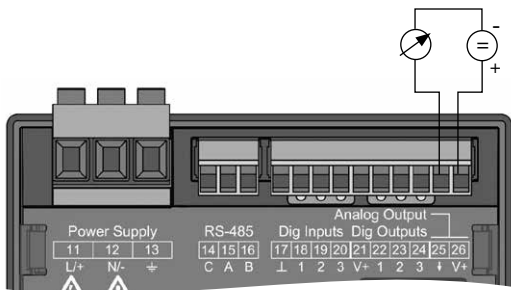
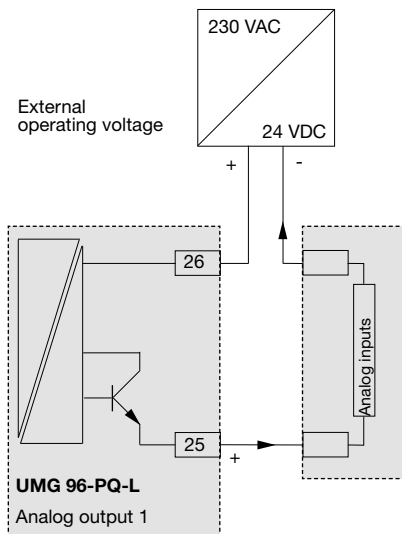

Fig. Analog output connection



11. Operation

The device is operated via 6 function buttons which have different functions:

- Selecting measuring displays.
- Navigation within the menus.
- Editing device settings.

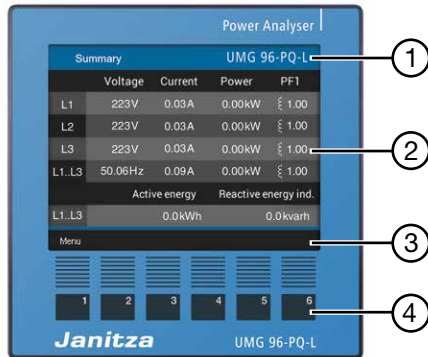

Fig. 96-PQ-L measuring display "Summary"

Item	Function/Designation
1	Title displayed
2	Measured values
3	Labeling of the function buttons
4	Function buttons

Tab.: Operating the device

11.1 Button function

Button	Function
1	<ul style="list-style-type: none"> • Display Menu • Exit Menu • Cancel action (<i>Esc</i>)
2	<ul style="list-style-type: none"> • Go to the start screen. • Select position (to the left "◀"). • Configuration of a measuring display as the start screen (press until message appears).
3	<ul style="list-style-type: none"> • Select menu item or position (down "▼") • Change (selection, number -1).
4	<ul style="list-style-type: none"> • Select menu item or position (up "▲") • Change (selection, number +1)
5	<ul style="list-style-type: none"> • Select position (to the right "▶")
6	<ul style="list-style-type: none"> • Confirm selection (<i>Enter</i>)

11.2 Measuring display "Summary"

Start screen, UMG 96-PQ-L:

After restoration of network power, the **UMG 96-PQ-L** starts with the measuring display *Summary*.

The measuring display *Summary* contains the device name and an overview of important measured values. In the delivery condition, the device name consists of the type and the serial number of the measurement device.

Button 2 (*Home*) takes you back to the start screen *Summary* from any display (default setting).

The image shows the 'Summary' display of the UMG 96-PQ-L power analyser. The display is divided into several sections. At the top, it says 'Summary UMG 96-PQ-L'. Below this is a table with columns for Voltage, Current, Power, and PF1. The table lists data for L1, L2, L3, and L1..L3. Below the table, there are sections for 'Active energy' and 'Reactive energy ind.' with values for L1..L3. At the bottom, there is a 'Menu' button.

Fig. Measuring display "Summary" - measurement in a three-phase four-wire network (default setting).

i INFORMATION

- The representation above of the measuring display "Summary" depends on the network system configuration of your measurement device. In this regard, please take note of section „12.4.2 Connection variant“ on page 47.
- To configure a new start screen, please refer to section „11.5 Configuring a new start screen“ on page 43.

11.3 Menu

Button 1 opens the menu of your measurement device:

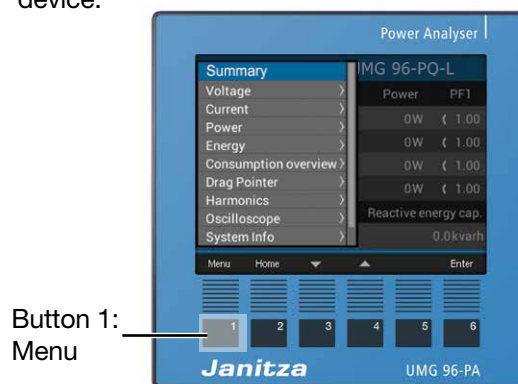
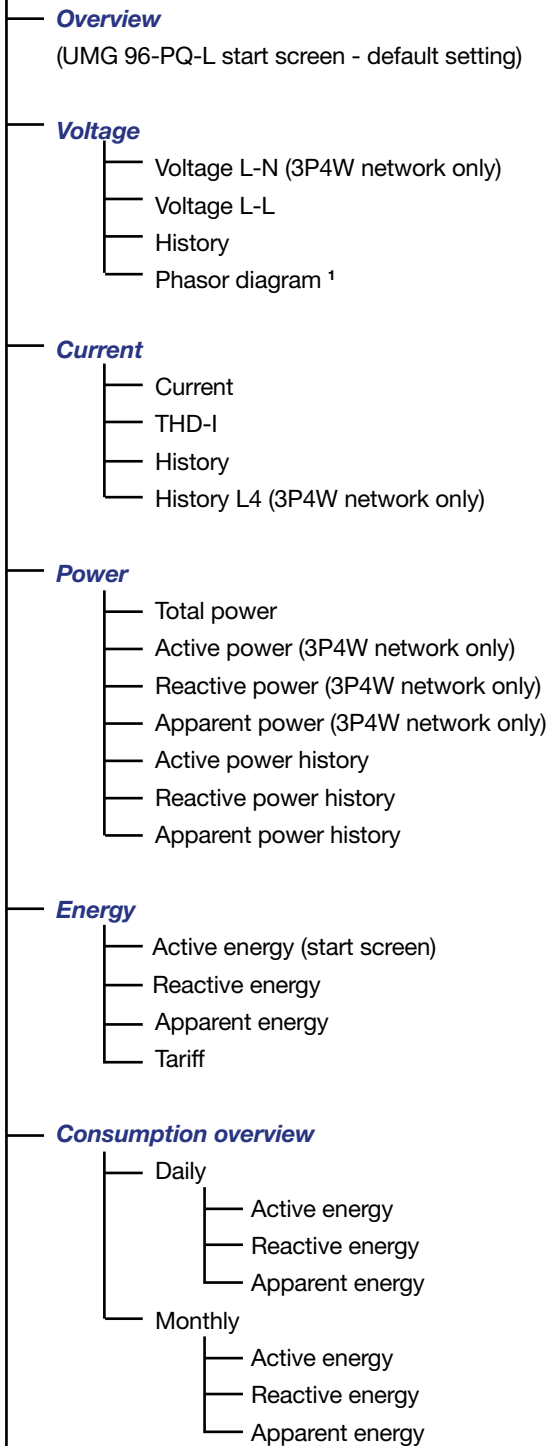

Fig. UMG 96-PQ-L "Summary"

11.4 Overview of menu displays

Menu



Drag indicator

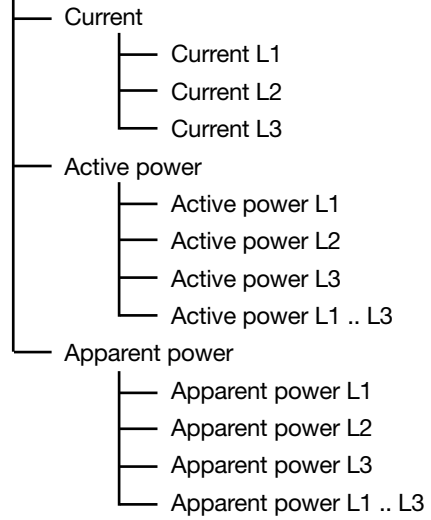

Harmonics

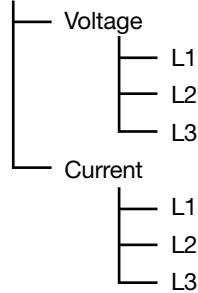

Oscilloscope

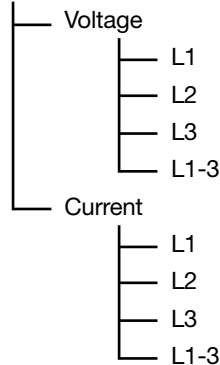

Events

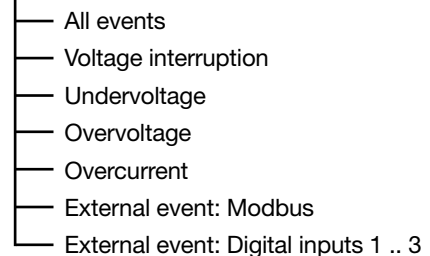

¹... 3P4W network system - star
3P3W network system - triangle

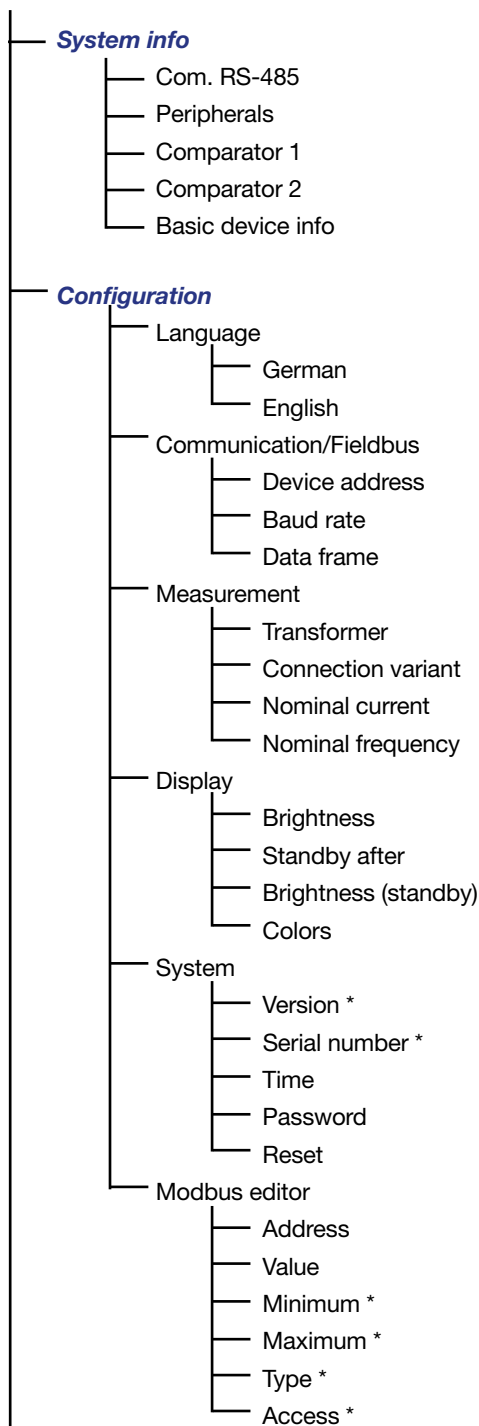

Select the menu item:

- Use *buttons* 3 (▼) and 4 (▲) to select the menu item.
- Confirm this with *button* 6 (Enter).
- Use *button* 1 (Esc) to leave the selection.
- Use *button* 2 (Home) to go to the start screen “Summary” (default setting).

i INFORMATION

- **Ex works, the UMG 96-PQ-L has the Password 00000 (no password).**
- The measurement device locks the device configuration for 10 min. if the password is entered incorrectly 5 times.
- Write down your password and keep it safe!
- Without the password you cannot configure your device! Notify the device manufacturer’s Support if the password is lost!

11.5 Configuring a new start screen

i INFORMATION

- **In the default setting of the measurement device, the display “Summary” is configured as the start screen.**
- Any **measuring display** of the device can be configured as the new start screen by pressing and holding *button* 2 (Home). To do so, go to the corresponding **measuring display** and press *button* 2 (Home) until the message “**Home display reset**” appears.

i INFORMATION

The entries in the menu display overview depend on the network system configuration of your measurement device (three-phase 4-wire system or three-phase 3-wire system). In this regard, please take note of section „12.4.2 Connection variant“ one page 47

* ... not configurable

12. Configuration

12.1 The Configuration window

The *Configuration* menu of the device contains all parameters in which you make settings. The device requires the supply voltage for configuration. To do so, proceed as described in 13.1 on page 58:

- Use button 2 (*Home*) to go to the start screen *Summary* (default setting).
- Open the menu with button 1 (*Menu*).
- Use buttons 3 (▼) and 4 (▲) to select the menu item “Configuration” and confirm with button 6 (*Enter*).

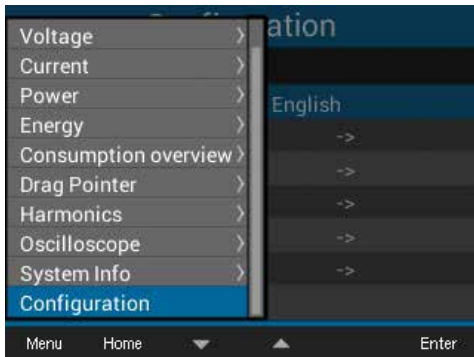

Fig. “Configuration” menu item

- The *Configuration* window appears.

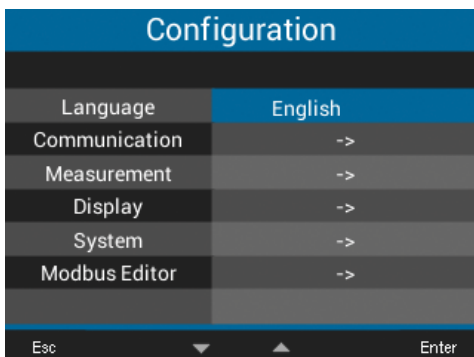

Fig. Configuration window with activated language item.

i INFORMATION

Password-protected devices require entry of a password before configuration! If your device is password protected, enter your password to access the *Configuration* window (see section „Setting the password“ on page 52).

12.2 Language

Use the *Language* item of the *Configuration* window to configure the language for the device's user interface:

- Open the *Configuration* window as previously described.
- Use buttons 3 (▼) and 4 (▲) to select the item *Language* and confirm with button 6 (*Enter*).
- The item *Language* is shown in yellow letters.

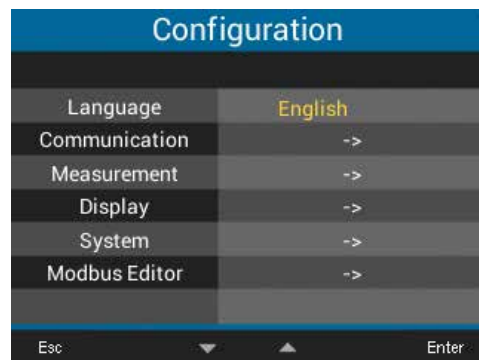

Fig. The Language Configuration window

- Use buttons 3 (▼) and 4 (▲) to select the language (*German* or *English*) and confirm with button 6 (*Enter*).
- The user interface entries change to the selected language.
- Use button 1 (*Esc*) to return to the menu.
- Then press button 2 *Home* to go to the start screen.

12.3 Communication

Use the *Communication* item of the *Configuration* window to configure parameters for the RS-485 interface of your device.

- Open the *Configuration* window as previously described.
- Use buttons 3 (▼) and 4 (▲) to select the item *Communication* and confirm with button 6 (*Enter*).
- The *Communication* window appears with the parameters:
 - Device address.
 - Baud rate.
 - Data frame.

Communication	
Field bus	
Device address	1
Baud rate	115200
Framing	1 stopbit
Esc	Enter

Fig. Communication window for fieldbus parameters (RS-485 interface)

- Use the *Communication* window to configure the parameters for the fieldbus (RS-485 interface), such as Device address, Baud rate and Data frame by selecting the respective item and confirming with button 6 (*Enter*).
- Depending on the parameter selected, the corresponding entry is shown in “yellow”.
- Use buttons 2 (◀) and 5 (▶) to change the position of the digit to be set for each item and use buttons 3 (▼) and 4 (▲) to change the digit (-1/+1).
- Confirm your entries with button 6 (*Enter*) or end the action by pressing button 1 (*Esc*).
- To return to the start screen, press button 1 twice (*Esc*) and then press button 2 (*Home*).

Settings

- **Device address:**
Select a device address for the device with which the device can be addressed in the bus structure. Each device address exists only once in a bus structure!
Setting range: 1 - 250
Default value: 1
- **Baud rate:**
Select a uniform baud rate for all devices in the bus structure!
Setting range: Auto, 9600, 19200, 38400, 57600, 115200 kbps
Default value: Auto

- **Data frame:**
Select a uniform data framework for all devices in the bus structure.
- **Setting range:**
 - “odd” (parity *odd* , with 1 stop bit)
 - “even” (parity *even*, with 1 stop bit)
 - “1 stop bit” (parity *none*, with 1 stop bit).
 - “2 stop bits” (parity *none*, with 2 stop bits).
 - Default value: 1 stop bit(no parity).

CAUTION

Material damage due to incorrect network settings.

Incorrect network settings can cause faults in the IT network.

Consult your network administrator for the correct network settings for your device.

12.4 Measurement

In the “Measurement” menu, configure the ratio of the current and voltage transformers (primary to secondary side), the connection variants, the nominal current and the nominal frequency.

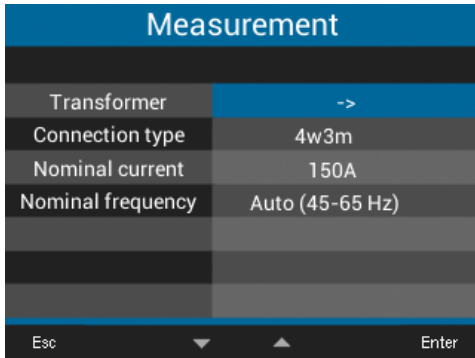

Fig. Measurement window with the entries transformer, connection variant, nominal current, nominal frequency

12.4.1 Current and voltage transformers

i INFORMATION

Before configuring the current and voltage transformer ratios, be certain to connect the transformers in compliance with the specifications on the device rating plate and the technical data!

- Open the *Configuration* window as previously described.
- Use buttons 3 (▼) and 4 (▲) to select the item *Measurement* and confirm with button 6 (Enter).
- The *Measurement* window appears.
- Use buttons 3 (▼) and 4 (▲) to select the item *Transformer* and confirm with button 6 (Enter).

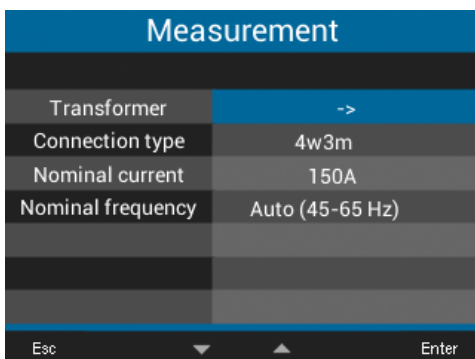

Fig. Measurement window with the item Transformer activated.

- The *Measurement* window appears with the settings for the current and voltage transformers (primary and secondary).

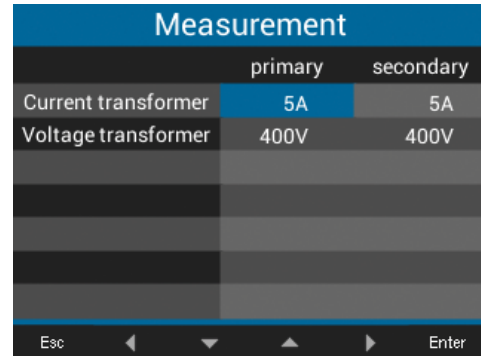

Fig. Measurement window with the entries for the transformers

- Use buttons 2 (◀), 3 (▼), 4 (▲) and 5 (▶) to select the entry for the primary or secondary side of the transformer to be set and confirm with button 6 (Enter).
- The selected item is shown “yellow”.
- Use buttons 2 (◀) and 5 (▶) to change the position of the digit to be set for each item and use buttons 3 (▼) and 4 (▲) to change the digit (-1/+1).
- Confirm your entries with button 6 (Enter) or end the action by pressing button 1 (Esc).
- To return to the start screen, press button 1 three times (Esc) and then press button 2 (Home).

Transformer settings:

- Current transformer (primary):
Setting range: 1 - 10000 A
Default value: 5 A
- Current transformer (secondary):
Setting range: 1 - 5 A
Default value: 5 A
- Voltage transformer (primary):
Setting range: 100 - 60000 V
Default value: 400 V
- Voltage transformer (secondary):
Setting range: 100 - 400 V
Default value: 400 V

Connection variant 3w2m

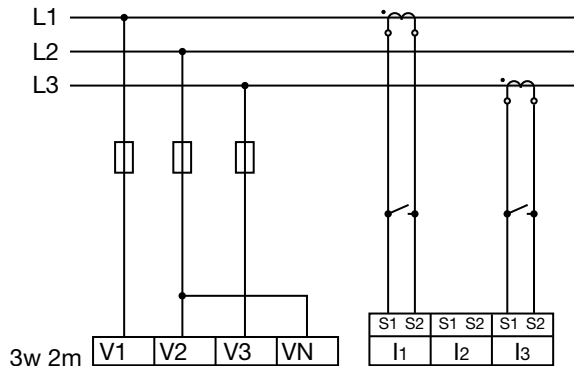

Fig. Connection variant 3w2m - measurement in a three-phase 3-conductor network with asymmetrical load.

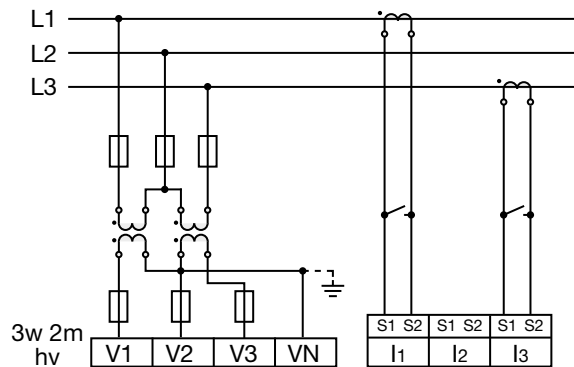

Fig. Connection variant 3w2m hv - measurement via 2 voltage transformers in a three-phase 3-conductor network with asymmetrical load.

12.4.3 Nominal current

For a defined operation of the device, you need the nominal current in addition to the settings of the current and voltage transformer ratios.

- Open the *Configuration* window as previously described.
- Use buttons 3 (▼) and 4 (▲) to select the item *Measurement* and confirm with button 6 (Enter).
- The *Measurement* window appears.
- Use buttons 3 (▼) and 4 (▲) to select the item *Nominal current* and confirm with button 6 (Enter).

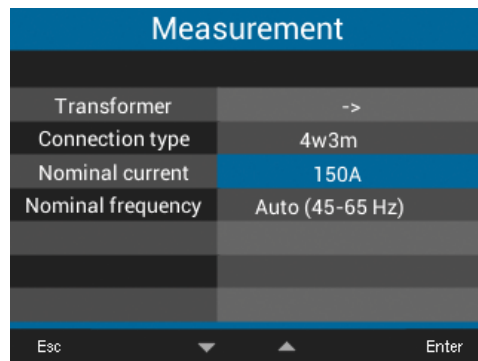

Fig. Measurement window with the item *Nominal current* activated.

- The item for the *Nominal current* is shown “yellow”.
- Use buttons 2 (◀) and 5 (▶) to change the position of the digit to be set for each item and use buttons 3 (▼) and 4 (▲) to change the digit (-1/+1).
- Confirm your entries with button 6 (Enter) or end the action by pressing button 1 (Esc).
- To return to the start screen, press button 1 twice (Esc) and then press button 2 (Home).

Nominal current settings:
 Setting range: 0 - 999999 A
Default value: 150 A

12.4.4 Nominal frequency

The device requires the mains frequency for the measurement and calculation of measured values. The device is suitable for measurements in networks with a frequency range of 45 - 65 Hz.

- Open the *Configuration* window as previously described.
- Use buttons 3 (▼) and 4 (▲) to select the item *Measurement* and confirm with button 6 (Enter).
- The *Measurement* window appears.
- Use buttons 3 (▼) and 4 (▲) to select the item *Nominal frequency* and confirm with button 6 (Enter).

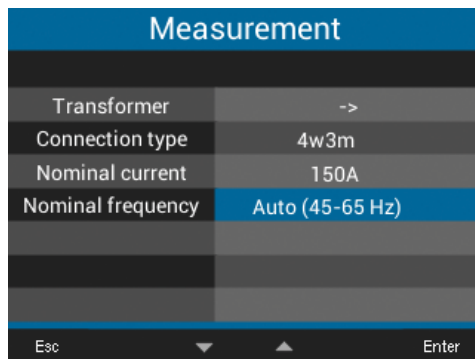

Fig. Measurement window with the item *Nominal frequency* activated.

- The item for the *Nominal frequency* is shown “yellow”.
- Select your frequency range with buttons 3 (▼) and 4 (▲).
- Confirm your entries with button 6 (Enter) or end the action by pressing button 1 (Esc).
- To return to the start screen, press button 1 twice (Esc) and then press button 2 (Home).

Setting ranges for **Nominal frequency**:

- Auto (45-65 Hz) - Standard setting
- 60 Hz (const. frequency)
- 50 Hz (const. frequency)

i INFORMATION

Measurement devices with the setting **Auto** need about 5 seconds to determine the mains frequency. During this time, the measured values **do not** maintain the guaranteed measurement uncertainty.

To determine the mains frequency, the measurement device requires a voltage $> 20V_{rms}$ (4-wire measurement) or a voltage $L1-L2 > 34V_{rms}$ (3-wire measurement) on voltage measurement input V1.

i INFORMATION

If the mains frequency is outside the range of 45-65 Hz:

- There is no error or warning alert.
- When a constant frequency (50/60 Hz) is indicated, the corresponding setting is used.
- When automatic frequency detection is selected (Auto), the last determined frequency in the range of 45-65 Hz is used.

The determination of the frequency runs over a period of 10 seconds. The frequency does **not** represent a 200 ms measured value!

12.5 Display

Use the item *Display* of the measurement device to configure the following display settings:

- Brightness,
 - Standby after,
 - Brightness (standby) and
 - Colors.
- Open the *Configuration* window as previously described.

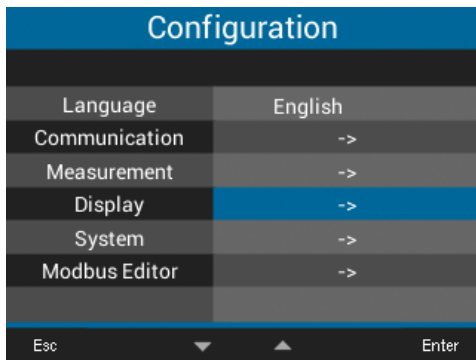

Fig. Configuration window with *Display* item activated.

- Use buttons 3 (▼) and 4 (▲) to select the item *Display* and confirm with button 6 (Enter).
- The *Display* window appears.

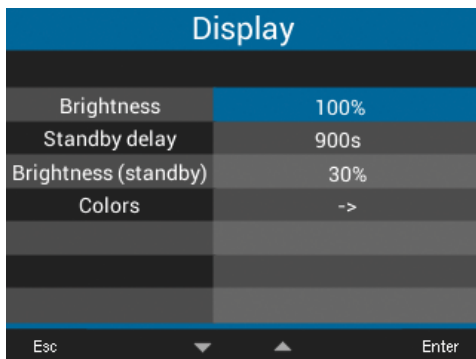

Fig. Display window

- Use buttons 3 (▼) and 4 (▲) to select the corresponding item of the *Display* window and confirm with button 6 (Enter).
- The entries for Brightness, Standby after and Brightness (Standby) are shown “yellow”. The item Colors leads to the *Colors* window.
- Use buttons 2 (◀) and 5 (▶) to change the position of the digit to be set for each item and use buttons 3 (▼) and 4 (▲) to change the digit (-1/+1).

- Confirm your entries with button 6 (Enter) or end the action by pressing button 1 (Esc).
- To return to the start screen, press button 1 twice (Esc) and then press button 2 (Home).

12.5.1 Brightness

Display brightness of the measurement device.

- Setting range: 30% - 100%
- Default value: 70%

with 30% = dark
100% = very bright

12.5.2 Standby after

Time in seconds after which the display brightness is set to the *Brightness (Standby)* that has been configured.

- Setting range: 60 s - 3600 s
- Default value: 900 s

12.5.3 Brightness (standby)

Display brightness to which the meter switches after the standby time has expired.

- Setting range: 20% - 60%
- Default value: 30%

with 20% = dark
60% = very bright

12.5.4 Colors

Colors for the display of current and voltage in the graphical visualizations.

- Open the *Configuration* window as previously described.
- Use buttons 3 (▼) and 4 (▲) to select the item *Display* and confirm with button 6 (Enter).
- The *Display* window appears.
- Use the buttons 3 (▼) and 4 (▲) to select the item *Colors* and confirm with button 6 (Enter).
- The *Colors* window appears.



Fig. Colors window

- Use buttons 2 (◀), 3 (▼), 4 (▲) and 5 (▶) to select the color for the voltage or current of the phase to be set and confirm with button 6 (Enter).
- The selected color is shown framed in blue.
- Use buttons 3 (▼) and 4 (▲) to select the desired color and confirm with button 6 (Enter) or end the action with button 1 (Esc).
- To return to the start screen, press button 1 three times (Esc) and then press button 2 (Home).

12.6 System

In the *System* window, the user of the measurement device can:

- View device-specific system settings.
- Configure a password.
- Delete or reset measured values and device parameters.
- Open the *Configuration* window as previously described.
- Use buttons 3 (▼) and 4 (▲) to select the item *System* and confirm with button 6 (Enter).

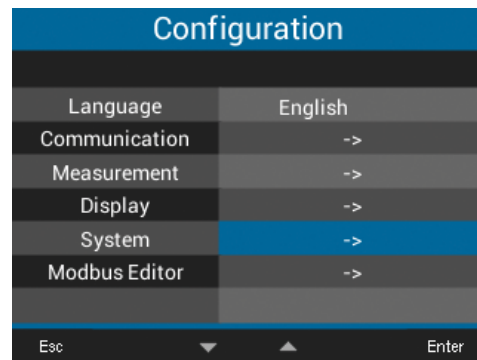

Fig. Configuration window with the System item activated.

- The *System* window appears.

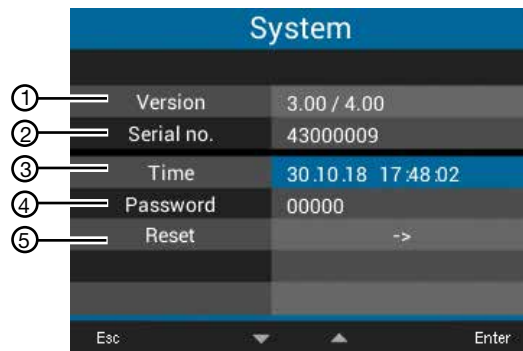

Fig. System window

Item	Function/Designation
1	Firmware version
2	Serial number of the measurement device
3	Date/time
4	Password function
5	Reset function

Tab.: Entries in the System window

12.6.1 Firmware/Serial number

The firmware and the serial number of the measurement device are required for support requests or registration on the homepage (www.janitza.de).

12.6.2 Date/time

Setting the date and time. You can change the settings for synchronization, the date and time zones via

- the GridVis® software or
- the Modbus addresses

(See section “14.12 Synchronization” on page 53).

12.6.3 Password

Use a password to block access to the configuration. The device can only be configured after entering the password.

The password consists of a number combination of up to 5 digits.

Setting ranges:

- 1-99999 = with password
- 00000 = without password

Default value:

00000 = without password

The UMG 96-PQ-L is delivered ex works with the password 00000 (no password) configured.

For a password change, you need the current password!

i INFORMATION

- The measurement device locks the device configuration for 10 min. if the password is entered incorrectly 5 times.
- Write down your password and keep it safe!
- Without the password you cannot configure your device! Notify the device manufacturer's Support if the password is lost!

Setting the password

- Open the *Configuration* window as previously described.
- Use buttons 3 (▼) and 4 (▲) to select the item *System* and confirm with button 6 (Enter).
- The *System* window appears.
- Use buttons 3 (▼) and 4 (▲) to select the item *Password* and confirm with button 6 (Enter).
- The entry for the *Password* is shown “yellow”.

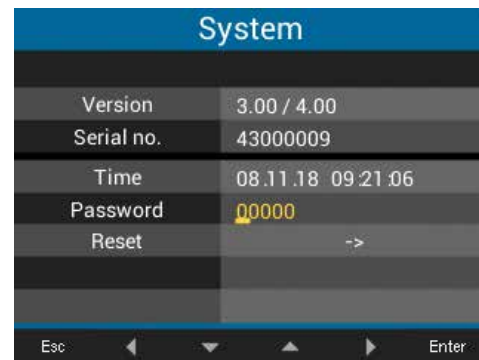

Fig. System window with the item Password activated

- Use buttons 2 (◀) and 5 (▶) to change the position of the digit to be set for each item and use buttons 3 (▼) and 4 (▲) to change the digit (-1/+1).
- Confirm your entries with button 6 (Enter) or end the action by pressing button 1 (Esc).
- To return to the start screen, press button 1 twice (Esc) and then press button 2 (Home).

12.6.4 Reset

This function is used to delete and reset measured values and device parameters.

Energy

You can delete all energy meters in the device simultaneously. It is not possible to select certain energy meters.

- Open the *Configuration* window as previously described.
- Use buttons 3 (▼) and 4 (▲) to select the item *System* and confirm with button 6 (Enter).
- The *System* window appears.
- Use buttons 3 (▼) and 4 (▲) to select the item *Reset* and confirm with button 6 (Enter).
- The *Reset* window appears.

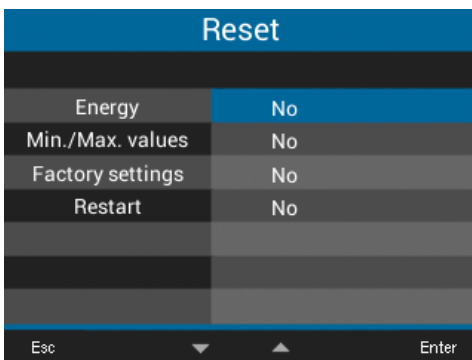

Fig. Reset window, resetting the energy meters

- Use buttons 3 (▼) and 4 (▲) to select the item *Energy* and confirm with button 6 (Enter).
- The entry for the *Energy* is shown “yellow”.
- Use buttons 3 (▼) and 4 (▲) to select “Yes” or “No”.
- Confirm your entries with button 6 (Enter) or end the action by pressing button 1 (Esc).
- To return to the start screen, press button 1 three times (Esc) and then press button 2 (Home).

Minimum and maximum values

With this function, the device user deletes all min. and max. values in the device simultaneously. It is not possible to select certain energy meters.

i INFORMATION

Before commissioning, delete any production-related contents of the energy meters, Min./Max. values and records!

- Open the *Configuration* window as previously described.
- Use buttons 3 (▼) and 4 (▲) to select the item *System* and confirm with button 6 (Enter).
- The *System* window appears.
- Use buttons 3 (▼) and 4 (▲) to select the item *Reset* and confirm with button 6 (Enter).
- The *Reset* window appears.

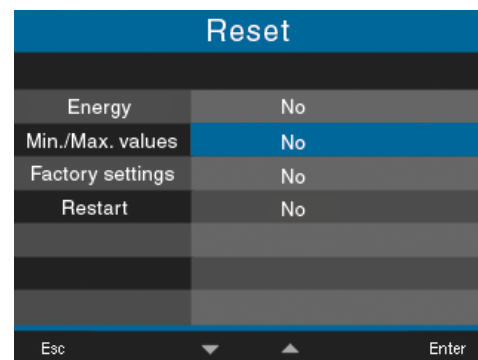

Fig. Reset window, delete min/max values

- Use buttons 3 (▼) and 4 (▲) to select the item *Min./max. values* and confirm with button 6 (Enter).
- The entry *Min./Max. values* is shown “yellow”.
- Use buttons 3 (▼) and 4 (▲) to select “Yes” or “No”.
- Confirm your entries with button 6 (Enter) or end the action by pressing button 1 (Esc).
- To return to the start screen, press button 1 three times (Esc) and then press button 2 (Home).

Standard factory settings

This function resets all settings, such as configurations and recorded data, to the factory settings.

- Open the *Configuration* window as previously described.
- Use buttons 3 (▼) and 4 (▲) to select the item *System* and confirm with button 6 (Enter).
- The *System* window appears.
- Use buttons 3 (▼) and 4 (▲) to select the item *Reset* and confirm with button 6 (Enter).
- The *Reset* window appears.
- Use buttons 3 (▼) and 4 (▲) to select the item *Standard factory setting* and confirm with button 6 (Enter).



Fig. Reset window, standard factory settings

- The item *Standard factory setting* is shown “yellow”.
- Use buttons 3 (▼) and 4 (▲) to select “Yes” or “No”.
- Confirm your entries with button 6 (Enter) or end the action by pressing button 1 (Esc).
- Use button 6 (Enter) to confirm the warning message or end the action with button 1 (Menu).
- Pressing button 6 (Enter) resets the device to the standard factory settings.

Restart

This function restarts the measurement device.

- Open the *Configuration* window as previously described.
- Use buttons 3 (▼) and 4 (▲) to select the item *System* and confirm with button 6 (Enter).
- The *System* window appears.
- Use buttons 3 (▼) and 4 (▲) to select the item *Reset* and confirm with button 6 (Enter).
- The *Reset* window appears.

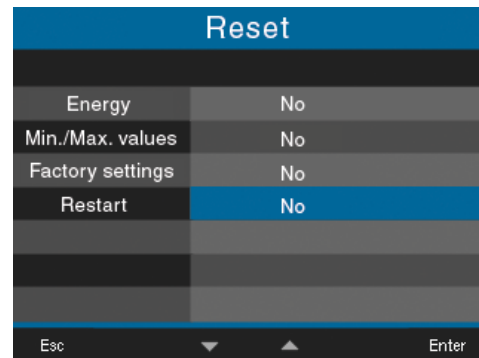

Fig. Reset window, restart device

- Use buttons 3 (▼) and 4 (▲) to select the item *Restart* and confirm with button 6 (Enter).
- The item *Restart* appears in “yellow”.
- Use buttons 3 (▼) and 4 (▲) to select “Yes” or “No”.
- Confirm your entries with button 6 (Enter) or end the action by pressing button 1 (Esc).
- Pressing button 6 (Enter) restarts the device.

12.7 Modbus editor

The function **Modbus Editor** is used to configure various functions or to read out measured values directly on the measurement device, without parametrization software or a network connection. Your measurement device does not require a network connection for this.

i INFORMATION

Optionally, you can configure Modbus addresses easily and conveniently in the GridVis® software.

You can use the Modbus address list (download at www.janitza.de) to configure the **analog output** of the measurement device, for example, via the device keyboard.

Example of configuring the measured value for the analog output:

To assign a measured value to the analog output of your measurement device, write the Modbus address of the measured value (see the table of frequently used measured values) to the

Modbus address 30001

To configure a start value for your measured value, write the start value to the

Modbus address 30002

A final value for your measured value can be entered in

Modbus address 30004

To assign the output ranges to the analog output of a device, write as follows to the

Modbus address 30006

- a 0 for the output range 0-20 mA;
- a 1 for the output range 4-20 mA.

i INFORMATION

Further information on the analog outputs can be found in chapter „10. Analog outputs“ on page 40 and in section „13.15 Configuration of the analog output“ on page 74.

Table of frequently used measured values

Frequently used measured values and their Modbus addresses for output on the **analog output (Modbus address 30001)**:

Modbus address	Measured value
19026	Active power, sum L1-L3, instantaneous value
19042	Reactive power, sum L1-L3, instantaneous value
19012	Current L1, instantaneous value
19014	Current L2, instantaneous value
19016	Current L3, instantaneous value
1050	Cos phi sum L1-L3, instantaneous value
For measurement devices with RCM module	
20053	Neutral conductor current I4, instantaneous value
20055	Residual current RCM 1 (I5), instantaneous value
20057	Residual current RCM 2 (I6), instantaneous value
20061	Temperature, instantaneous value

Tab.: Modbus addresses of frequently required measured values.

i INFORMATION

A continuation of the table can be found in section „19.1 Modbus addresses of frequently used measured values“ on page 116.

You can access the Modbus editor as follows:

- Open the *Configuration* window as previously described.
- Use buttons 3 (▼) and 4 (▲) to select the item *Modbus editor* and confirm with button 6 (Enter).

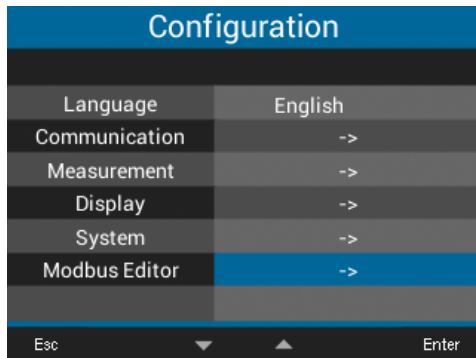

Fig. Configuration window, Modbus editor

- The *Communication* window appears with the *Modbus editor*.

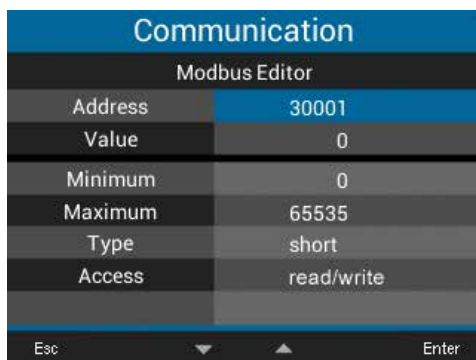

Fig. Communication window, Modbus editor

- Use buttons 3 (▼) and 4 (▲) to select the item *Address* or *Value* and confirm with button 6 (Enter).
- The selected item is shown “yellow”.
- Use buttons 2 (◀) and 5 (▶) to change the position of the digit to be set for each item and use buttons 3 (▼) and 4 (▲) to change the digit (-1/+1).
- Confirm your entries with button 6 (Enter) or end the action by pressing button 1 (Esc).
- To return to the start screen, press button 1 twice (Esc) and then press button 2 (Home).

Example for the measured value *Active power*:

- In the *Configuration* window, select the item *Modbus editor* and confirm with button 6 (Enter).
- The *Communication/Modbus Editor* window appears with the items *Address* and *Value*.
- Select the item *Address* and press button 6 (Enter).
- The item *Address* is shown “yellow”.
- Use buttons 2 (◀), 5 (▶), 3 (▼) and 4 (▲) to configure the number 30001.
- Confirm the entry with button 6 (Enter).
- Then select the item *Value* and press button 6 (Enter).
- The item *Value* is shown “yellow”.
- Use buttons 2 (◀), 5 (▶), 3 (▼) and 4 (▲) to configure the number 19026 for the measured value *Active power sum*, L1-L3.
- Then configure the *Start* and *End value* of the active power in the addresses 30002 and 30004. For example, start value 500 W and end value 1000 W. Please note that the measured value variables must always be entered in the basic unit (e.g. W, A, V).

Further information on this example can be found in section „13.15 Configuration of the analog output“ on page 74.

***i* INFORMATION**

- Measured values and Modbus addresses for the analog outputs can be configured easily and clearly in the GridVis® software (see www.janitza.de).
- Using the GridVis® software requires a connection between the measurement device and a PC (server) running the GridVis® software (see chapter „8. Connection and PC connections“ on page 34).
- Also observe the documentation for the RCM modules.

12.8 Events

i INFORMATION

Please note!

- You must configure events in the GridVis® software.
- Only Meters with firmware version 3.3 or higher have the "Events" function for recording faults in the supply or power grid.
- Further information on the "Events function" can be found on Page 86 and in the online GridVis® software help.

In the GridVis® software, you can easily and clearly configure all the important parameters for recording events, such as:

- Nominal values
- Event types
- Measured values
- Limit values
- Hysteresis

In addition, the GridVis® software visualizes recorded events in an event browser and provides assistance concerning the events in the form of informational texts and graphics.

The screenshot displays the 'Device configurator' for a 'Basic Device' UMG 96-PQ-L. The device details include IP-Address: 192.168.3.69, MAC-Address: 00:0E:6B:0D:00:12, Firmware: Core: 3.30 (Extension: 3.30) (Modul: 2.16), Mo..., Serial Number: 2700-0025 (Modul: 4500-0018), and Hardware Revision: 1, UMG96PQL RCM-EL. The 'Measurement' tab is active, showing a 'Power Quality' configuration panel. The 'Voltage' section is selected, displaying three event types: Voltage outage, Over voltage, and Under voltage. Each event type has a toggle switch and associated threshold and hysteresis values.

Event Type	Threshold	Hysteresis
Voltage outage	-95 % = 11.5 V	2 % = 4.6 V
Over voltage	+10 % = 253.0 V	2 % = 4.6 V
Under voltage	-15 % = 195.5 V	2 % = 4.6 V

Fig. Configuration of the events in the GridVis software®

13. Commissioning

13.1 Applying the supply voltage

1. Connect the supply voltage with a terminal on the back of the device.
2. After connection of the supply voltage, the start screen *Summary* appears (default setting) on the display of your measurement device.
3. If no display appears, check whether the supply voltage is within the nominal voltage range.

CAUTION

Material damage due to disregard of the connection instructions!

Disregard of the connection instructions can damage or destroy your device.

Observe the following:

- Observe the voltage and frequency specifications on the rating plate!
- Do not use the device for measuring DC voltage!

INFORMATION

Before commissioning, delete any production-related contents of the energy meters, Min./Max. values and records (see section „Minimum and maximum values“ on page 53)!

13.2 Measured voltage

INFORMATION

In networks with nominal voltages that exceed the specified nominal voltages, connect the voltage measurement inputs via voltage transformers (see section „7.1 Nominal voltages“ on page 25)!

Connect measured voltage:

1. Connect the measured voltage to the terminals of the voltage measurement inputs on the back of the device.
2. After connecting the measured voltage, check the measured values displayed by the device for the voltages L-N and L-L.
Take into account any voltage transformer factors that may be set!

WARNING

Risk of injury due to electrical voltage!

If the device is exposed to surge voltages above the permissible overvoltage category, safety-relevant areas of insulation in the device can be damaged. This means that the safety of the product can no longer be guaranteed.

Only use the device in environments in which the permissible overvoltage category is not exceeded.

13.3 Measured current

The device:

- Is designed for the connection of current transformers with secondary currents of ≈ 1 A and ≈ 5 A.
- Does not measure DC currents.

The factory-set current transformer ratio is 5/5 A and must be adapted to the current transformers used as needed.

1. Short-circuit all current transformer outputs except one.
2. Compare the current displayed on the device with the applied input current.
 - The currents must match after taking the current transformer ratio into account.
 - In the short-circuited current measurement inputs, the device must indicate approx. 0 amperes.

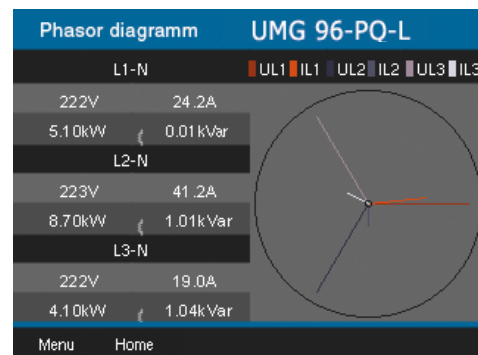

Fig. Phasor diagram

13.4 Frequency

For the measurement and calculation of measured values, the device requires the nominal or mains frequency. The mains frequency can either be specified by the user or determined automatically by the device.

- To determine the mains frequency, the voltage measurement input V1 requires a voltage greater than 20 V_{eff} (4-wire measurement) or an L1-L2 voltage of greater than 34 V_{eff} (3-wire measurement).
- The mains frequency must be in the range from 45 Hz to 65 Hz.
- If the measured voltage is not sufficiently high, the device cannot determine the mains frequency and therefore cannot carry out a measurement.

For further information, see section „12.4.4 Nominal frequency“ on page 49.

13.5 Direction of rotary field

Check the direction of the voltage rotating field in the measuring display of the device.

- Usually it is a “right” rotating field.

UL1-UL2-UL3 = right rotating field
UL1-UL3-UL2 = left rotating field

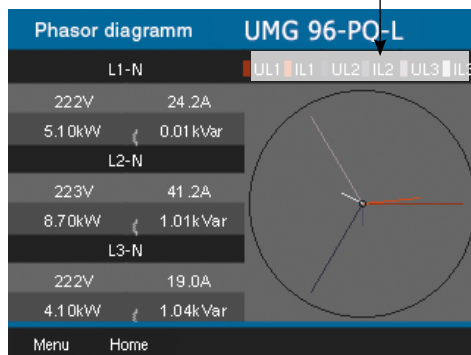

Fig. Phasor diagram window showing the phase sequence according to the direction of the rotary field

To check the voltage rotating field, open the menu display “Phasor diagram”:

- If you are not in the start screen, you can go to this view by pressing button 2 (Home).
- Open the menu with button 1 (Menu).

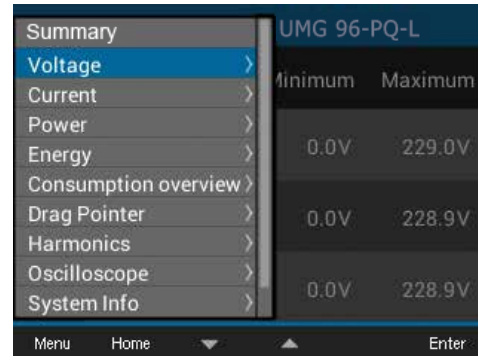

Fig. Voltage menu item

- Use buttons 3 (▼) and 4 (▲) to select the item Voltage and confirm with button 6 (Enter).
- The submenu with the item Phasor diagram appears.

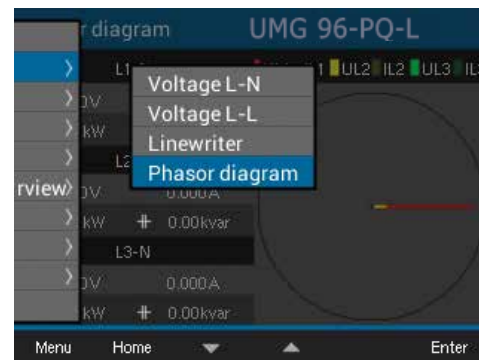

Fig. Submenu item Phasor diagram

- Use buttons 3 (▼) and 4 (▲) to select the item Phasor diagram and confirm with button 6 (Enter).
- The Phasor diagram window appears.

13.5.1 Fundamentals on the phasor diagram

The phasor diagram graphically describes the phase shift or phase angle between the voltage and the current. The phasors rotate at a constant angular speed – proportional to the frequency of the voltage and current – around an origin. The phasor diagram thus shows the momentary state of the variables in an AC circuit.

Representation of ohmic resistance:

- Voltage and current are in phase.

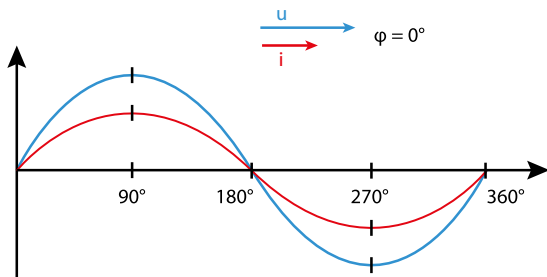

Representation of inductance:

- The voltage is ahead of the current.
- The phase shift for an “ideal coil” is 90°.

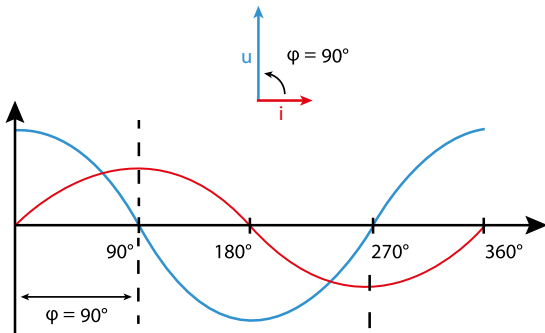

Representation of capacitance:

- The current is ahead of the voltage.
- The phase shift of an “ideal capacitor” is 90°.

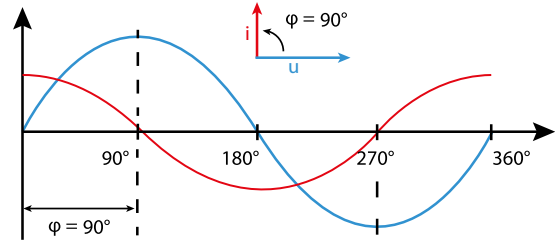

With a combination of the states, the phase angle “current to voltage” can assume values between -90° and +90°.

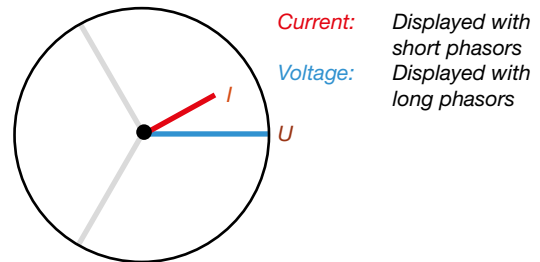

Example phasor diagram (3-phase)

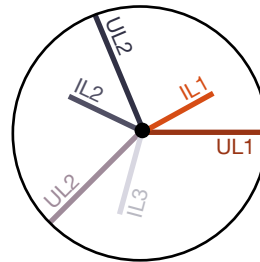

Current and voltage are shifted against each other. The current is ahead the voltage, i.e. the network is capacitively loaded.

13.6 Checking of voltage and current inputs by means of phasor diagram

The phasor diagram can be used to check incorrect connections at the voltage and current inputs.

Example 1

Primarily ohmic load.

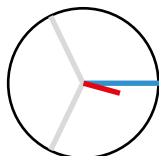

Voltage and current have only a small deviation in the phase position.

- The current measurement input is assigned to the correct voltage measurement input

Example 2

Primarily ohmic load.

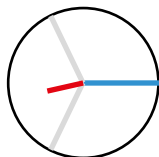

Voltage and current have a deviation of about 180° in the phase position.

- The measured current input is assigned to the correct voltage measurement input.
- In the current measurement under consideration, the connections k and l are reversed or there is a feedback into the supply network.



WARNING

Material damage due to disregard of the connection instructions!

Voltages and currents outside the permissible measuring range can destroy the device.

Comply with the measuring range specifications from the technical data.

13.7 Overrange

If the measuring range is exceeded, a warning appears in the device display, e.g. for the voltage, the warning “Overvoltage” with an indication of the voltage circuit.

The overrange message is displayed as long as the condition is present. Alarms can be acknowledged with button 5 *Alarms*. The measuring range is exceeded if at least one of the voltage or current measurement inputs lies outside its specified measuring range.

Limit values for overrange (200 ms effective values):

$$I = 6 A_{\text{rms}}$$

$$U_{L-N} = 600 V_{\text{rms}}$$

Overvoltage L1 11:34				
	Voltage	Current	Power	PF1
L1	0V	0.000A	0.00kW	< 1.00
L2	0V	0.000A	0.00kW	< 1.00
L3	0V	0.000A	0.00kW	< 1.00
L1..L3	50.00Hz	0.000A	0.00kW	< 1.00
		Active energy		Reactive energy ind.
L1..L3	0.0kWh		0.0kvarh	
Menu			Alarms	

Fig. Example warning message, overvoltage in phase L1.

i INFORMATION

If the measuring range is exceeded, please check your installation and connections. Comply with the connection conditions specified in the technical data.

13.8 Checking the time

To enable correct assignment of times to the measurement data records requires a correct specification of the time. Check and, if needed, correct the time and date settings in the *Configuration / System* menu (see section „12.6.2 Date/time“ on page 52).

13.9 Control of the power measurement

Short-circuit all current transformer outputs except one and check the indicated powers.

- The device must only display power in the phase with the current transformer input that is not short-circuited.
- If this is not the case, check the connection of the measured voltage and measured current.

If the amount of active power is correct, but the sign of the active power is negative, this can have two causes:

1. The connections S1(k) and S2(l) on the current transformer are reversed.
2. Active energy is returned to the grid.

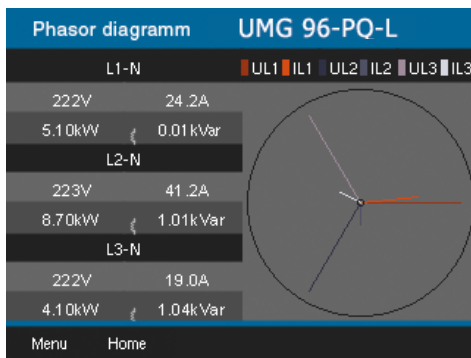

Fig. The phasor diagram shows voltages with long phasors and currents with short phasors.

Call up the phasor diagram with details on the power:

- If you are not in the start screen, you can go to this view by pressing button 2 (Home).
- Open the menu with button 1 (Menu).
- Use buttons 3 (▼) and 4 (▲) to select the item Voltage and confirm with button 6 (Enter).
- The submenu with the item *Phasor diagram* appears.
- Use buttons 3 (▼) and 4 (▲) to select the item *Phasor diagram* and confirm with button 6 (Enter).
- The *Phasor diagram* window appears.

13.10 Control of the communication

The device counts all received (RX), all sent (TX) and all faulty data packets.

Ideally, the number of errors in the Error column will be "0" (see figure below, window *Com. RS-485*).

- If you are not in the start screen, you can go to this view by pressing button 2 (Home).
- Open the menu with button 1 (Menu).
- Use buttons 3 (▼) and 4 (▲) to select the item *System Info* from the menu and confirm with button 6 (Enter).
- The following submenu appears:

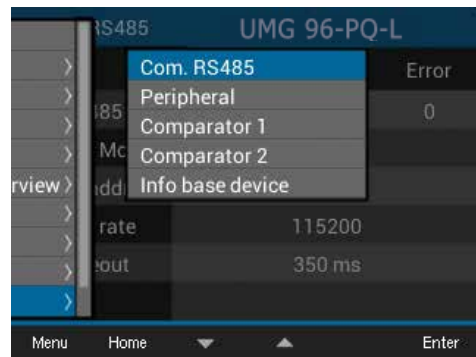

Fig. System Info submenu with Com. RS-485 item activated.

- Use buttons 3 (▼) and 4 (▲) to select the menu item *Com. RS-485* and confirm with button 6 (Enter).
- The *Com. RS-485* window appears with the parameters for the RS-485 communication interface.

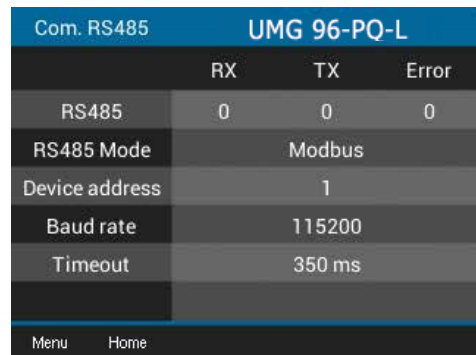

Fig. Display of the parameters that are set for the RS-485 communication interface.

13.11 Delete min./max. values

In the measuring displays for voltage, current and power, the device offers the function of deleting *Min./Max. values* using button 6 (*Enter*). The *Min./Max. values* can be deleted for the following measured values:

In the submenu **Voltage:**

- Voltage L-N
- Voltage L-L

In the window **Current:**

- Current
- THD-I (Total harmonic distortion - current)

In the window **Power:**

- Total power
- Active power
- Reactive power
- Apparent power

- If you are not in the start screen, you can go to this view by pressing button 2 (*Home*).
- Open the menu with button 1 (*Menu*).
- Use buttons 3 (▼) and 4 (▲) to select the item Voltage, Current or Power and confirm with button 6 (*Enter*).

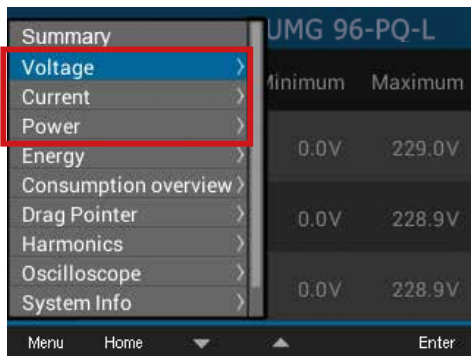

Fig. Voltage, current and power menus

The following description explains the *Delete min./max. values* function using the example of the measuring display *Voltage L-N*. Deleting the *Min./Max. values* for current and power requires the same procedure.

- The submenu for *Voltage* appears.
- In the submenu, select the item *Voltage L-N* with buttons 3 (▼) and 4 (▲) and confirm with button 6 (*Enter*).
- The voltage measuring display appears with the measured values L1-N, L2-N and L3-N.
- To delete the *Min./Max. values*, press button 6 (*Enter*).
- The *Min./max. values* submenu appears.
- In the *Min./Max. values* submenu, use buttons 3 (▼) and 4 (▲) to select the item *Delete* or end the action with the item *Cancel*.
- Confirm your action by pressing button 6 (*Enter*).

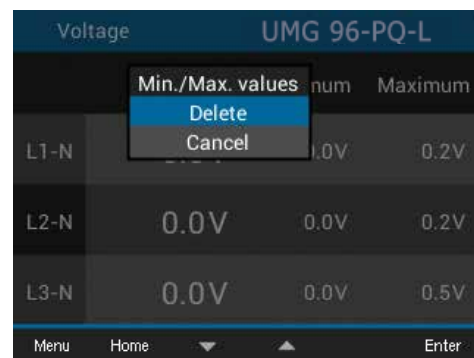

Fig. Measuring display, voltage L-N with menu Delete/Cancel min./max. values

13.12 Harmonics current (harmonics)

Harmonics current (harmonics) are caused, for example, by equipment with non-linear characteristics. These additional frequencies represent the integral multiple of a fundamental oscillation and show how the equipment affects the mains. Possible effects of harmonics are, for example:

- Additional heating of operating equipment.
- An additional current on the neutral conductor.
- An overload and a reduced service life of electrical consumers.

Harmonic loads are the main cause of invisible power quality problems involving enormous costs for servicing and investments for the replacement of defective equipment.

The device measures the fundamental oscillation of the voltage in the range of 45 - 65 Hz. The calculated harmonics of the voltages and currents refer to this fundamental oscillation.

The **UMG 96-PQ-L** calculates harmonics up to 65 times the fundamental oscillation.

- If you are not in the start screen, you can go to this view by pressing button 2 (*Home*).
- Open the menu with button 1 (*Menu*).
- Use buttons 3 (▼) and 4 (▲) to select the item Harmonics and confirm with button 6 (*Enter*).
- A selection list appears with voltage and current.
- Use buttons 3 (▼) and 4 (▲) to select Voltage, for example, and confirm with button 6 (*Enter*).
- A further selection list appears with the entries L1, L2 and L3.
- Use buttons 3 (▼) and 4 (▲) to select the respective phase (e.g. L1) and confirm with button 6 (*Enter*).
- The *Harmonics* window of the selected measured value appears.

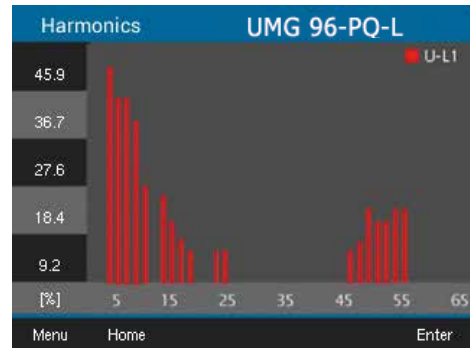

Fig. Measuring display for harmonics (e.g. Voltage L1)

13.13 Communication in the bus system

13.13.1 RS-485

The device sends and receives data via the RS-485 interface. For example, the device receives data from the parameter and measured value list via a MODBUS RTU protocol with CRC check.

Modbus functions (server device)

03 Read Holding Registers
 04 Read Input Registers
 06 Preset Single Register
 16 (10Hex) Preset Multiple Registers
 23 (17Hex) Read/Write 4X Registers

The order of the bytes is high before low byte (Motorola format).

Transmission parameters

Data bits: 8
 Parity: odd
 even
 none (1 stop bit)
 none (2 stop bits)

Stop bits (UMG 96-PQ-L): 1 / 2
 External stop bits: 1 / 2

Number formats

short 16 bit ($-2^{15} .. 2^{15} - 1$)
 Float 32 bit (IEEE 754)

For further information on configuring the RS-485 interface on the device, see section „12.3 Communication“ on page 44. For explanations of the connection and of the PC connection of the device via the interface, see section „8.2 RS-485 interface“ on page 35.

Example: Reading the voltage L1-N

The voltage L1-N is located in the list of parameters and measured values at address 19000 in the FLOAT format.

In this example 01 is assumed as the device address.

The “Query Message” then looks as follows:

Designation	Hex	Comment
Device address	01	Address=1
Function	03	“Read Holding Reg”
Start address Hi	4A	19000dec = 4A38hex
Start address Lo	38	
No. of values Hi	00	2dec = 0002hex
No. of values Lo	02	
Error check (CRC)	-	

The “response” of the device can then look as follows:

Designation	Hex	Comment
Device address	01	Address=1
Function	03	
Byte counter	06	
Data	00	00hex=00dec
Data	E6	E6hex=230dec
Error check (CRC)	-	

The voltage L1-N sent from address 19000 is 230 V.

13.14 Digital inputs/outputs

Your device has three digital outputs and three digital inputs.

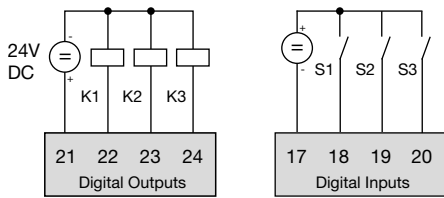

Fig. Digital outputs and inputs

- You configure the digital inputs and outputs using the GridVis® software
- The GridVis® software is available for download from our website (www.janitza.de).

13.14.1 Digital inputs

The digital inputs are used to send information to your device from other devices which have a digital output (pulse counter). There is also the option to configure digital inputs as function inputs (function mode). As a function input, each digital input has its own function. A function input **cannot** be configured as a pulse counter!

Using the configuration window of the GridVis® software, you can configure the digital inputs in the “Peripherals” area:

Function mode (On/Off mode)

- Function assigned to the digital input.

Pulse counter

- Value type of the incoming signal (e.g. electrical energy, gas/water consumption, CO2 ...)
- Pulse valency for measured or power values.
- Length of the averaging time.

The states of the digital inputs each have their own Modbus address. For each digital input, the last 16 switching operations (events) are logged with a time stamp.

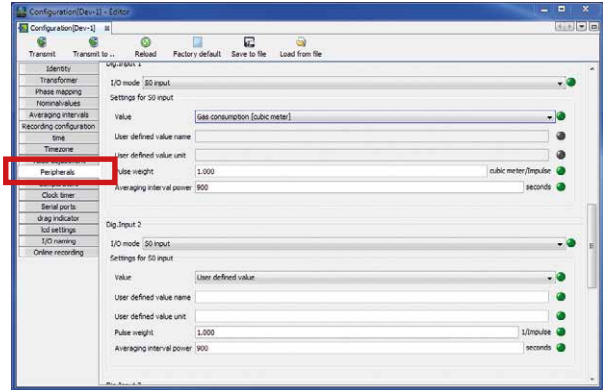

Fig. Configuration of the digital inputs via the GridVis® software

Function mode (On/Off mode)

A separate function can be assigned to each digital input:

- Digital input 1: Configuration as tariff switching (HT/LT).
- Digital input 2: Configuration for a synchronization of the device clock with the selection of minute or hour synchronization. The synchronization is also possible via a Modbus address.
- Digital input 3: Configuration as a reset input for the synchronous values of the drag indicator function. The synchronization of the drag indicator is also possible via a Modbus address.

Pulse counter

All digital inputs can be operated with a frequency of 25 Hz. The pulse duration (pulse width) and the pulse pause must be greater than 20 ms.

The typical pulse duration for S0 pulses is 30 ms.

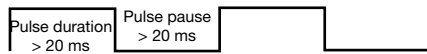

The maximum number of pulses per hour is calculated based on the minimum pulse duration and the minimum pulse pause:

Pulse length (pulse duration)	Pulse pause (pulse pause)	Max. pulses/h
20 ms	20 ms	90000 pul./h
30 ms	30 ms	60000 pul./h
50 ms	50 ms	36000 pul./h
100 ms	100 ms	18000 pul./h
500 ms	500 ms	3600 pul./h
1 s	1 s	1800 pul./h
10 s	10 s	180 pul./h

Fig. Examples for the maximum number of pulses per hour.

The pulse counters can be configured with simultaneous measured-value or power calculation. The pulses are counted as a 64-bit number and will overflow after approx. 1.17×10^{10} years of continuous operation (25 Hz).

Pulse valency

A pulse valency can be assigned to each digital input. With the pulse valency you specify which measured value or power value (e.g. energy) should correspond to one pulse.

i INFORMATION

The pulse interval is proportional to the power within the selected settings.

Measured value calculation:

$$\text{Measured value} = \text{pulse} \times \text{pulse valency}$$

Power value calculation:

$$\text{Power value} = \frac{\text{Pulse} \times \text{pulse valency}}{\text{Time [s]}}$$

Since the pulse interval can be very large, continuous calculation of the measured or power values is not possible. Consequently, only average values are calculated. The calculation of the average values for the measured value calculation results from the number of pulses per period multiplied by the pulse valency. For the calculation of the mean power values, this value must be divided by a configurable time value.

The period is assigned to the respective digital input and can be set to between 1 and 60 minutes. After the period has expired, the value can be called up via Modbus.

An external synchronization can be connected for each digital input, whereby one synchronization pulse completes a period and starts a new one. A capture time of 30 seconds is permanently preset for the external synchronization. If there is still no synchronous pulse after the period has expired, the software waits a maximum of 30 seconds and then synchronizes. All further periods are then synchronized by the software.

A period of 15 minutes is set at the factory.

The calculation result of the S0 power value is only available at the end of the period.

i INFORMATION

There is a selection of energy values derived from power values available in the GridVis® software for the configuration of pulse counters.

13.14.2 Digital outputs

Different functions can be assigned to the 3 digital outputs:

- Digital output 1¹⁾
 - Pulse output for active energy
 - Output for timer switch
 - Modbus remote output
- Digital output 2
 - Pulse output for reactive energy
 - Output for comparator group 1
 - Output for timer switch
 - Modbus remote output
- Digital output 3
 - Output for comparator group 2
 - Output for timer switch
 - Modbus remote output

Using the configuration window of the GridVis[®] software, you can define the digital outputs in the “Peripherals” area:

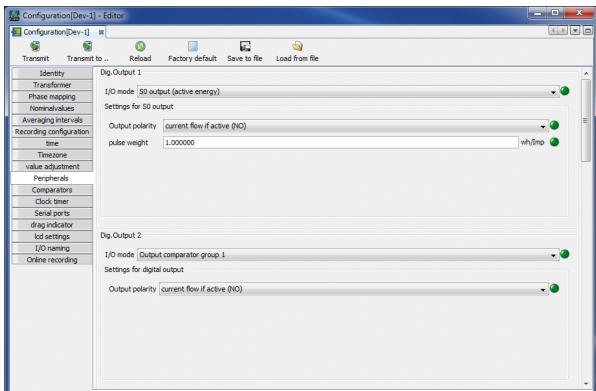

Fig. Configuration of the digital outputs via the GridVis[®] software

Pulse output

Digital output 1 and 2 can be used to output pulses for counting active and reactive energy. To do so, a pulse is applied to the output after a certain, configurable amount of energy has been reached.

To use a digital output as a pulse output, you must make various settings in the configuration menu using the GridVis[®] software:

- Pulse width
- Mode for the digital input: S0 output
- Output polarity: Normally open, normally closed
- Pulse valency

Pulse valency

The pulse valency indicates how much energy (Wh or varh) corresponds to one pulse.

The pulse valency is determined by the maximum connected load and the maximum number of pulses per hour.

If you indicate the pulse valency with:

- With a positive sign, pulses are only output if the measured value also has a positive sign.
- With a negative sign, pulses are only output if the measured value also has a negative sign.

i INFORMATION

Since the **Active energy meter** operates with a reverse running stop, the device only sends pulses when electrical energy is consumed.

Since the **Reactive energy meter** operates with a reverse running stop, the device only sends pulses when there is an inductive load.

Determine pulse valency

1. Set the pulse length according to the requirements of the connected pulse receiver. With a pulse length of 30 ms, for example, the device can emit a maximum of 60,000 pulses (see table „Examples for the maximum number of pulses per hour.“ one page 69) per hour.

Determine maximum connected load:

Example:

Current transformer = 150/5 A
Voltage L-N = max. 300 V

Power per phase = 150 A x 300 V
= 45 kW

Power with 3 phases = 45 kW x 3
Max. Connected load = 135 kW

2. Calculate pulse valency:

$$\text{Pulse valency} = \frac{\text{Max. connected load}}{\text{Max. number of pulses/h}} \quad [\text{Wh/pulse}]$$

$$\text{Pulse valency} = 135 \text{ kW} / 60000 \text{ pulses/h}$$

$$\text{Pulse valency} = 0.00225 \text{ kWh/pulse}$$

$$\text{Pulse valency} = 2.25 \text{ Wh/pulse}$$

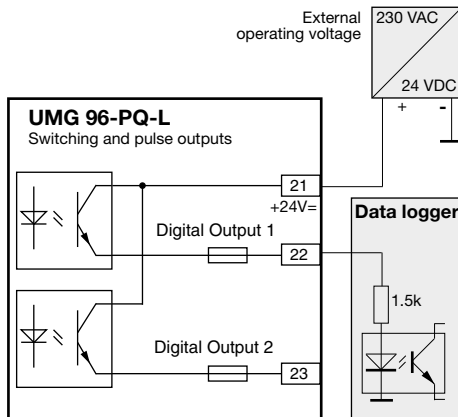

Fig. Connection example for wiring as a pulse output.

CAUTION

Measurement error when used as a pulse output.

When the digital outputs are used as pulse outputs, measurement errors can occur due to residual ripple.

For the supply voltage of the digital inputs and outputs, use a power supply whose residual ripple is less than 5% of the supply voltage.

Timer switch output

64 independent weekly timers can be configured in the device with:

- A resolution of 1 minute.
- A definable active period within one day. The active day within the week can be chosen.

Example:

Time 9:25 to 11:45 on Sunday, Monday and Friday.

The weekly timers can be configured as

- Tariff switching (1 and 2)
- Setting the digital outputs 1 to 3
- "no function"

The status can be called up via Modbus. The states of the timers at the digital output are linked with "OR".

The weekly timers can be configured via the GridVis® software in the menu item "Timer" in the "Configuration" window.

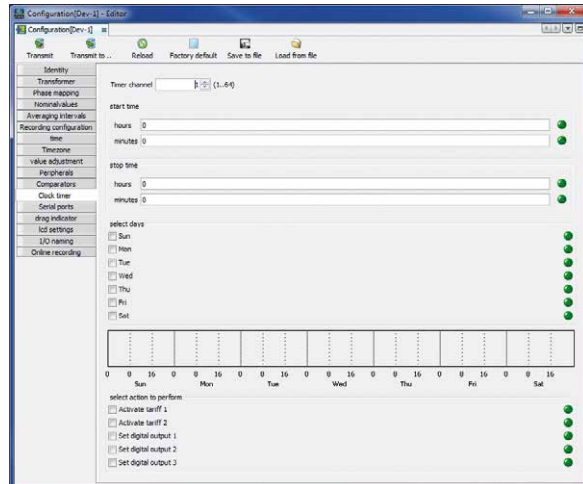

Fig. Configuration of the weekly timer (GridVis® software)

Output for Modbus remote

Switches the outputs via a Modbus address.

Configure the digital outputs as Modbus remote outputs in the GridVis® software as follows:

- Open the device configuration in GridVis®.
- Set the mode of the digital outputs under "Peripherals" to "Modbus Remote Output".
- Specify the output polarity with:
 - Current flow active (normally open contact)
 - Current flow inactive (normally closed contact)

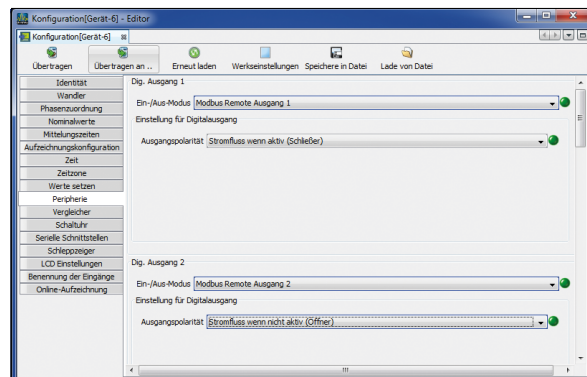

Fig. Configuration of the digital outputs as "Modbus Remote" in the GridVis® software

Output for comparator group

Two comparator groups (comparator 1 and 2) each with 3 comparators (A - C) are available for monitoring limit values.

The results of comparators A to C can be linked with “AND” or “OR”.

The logic result of comparator group 1 can be assigned to digital output 2 and the logic result of comparator group 2 can be assigned to digital output 3.

The comparators can be configured exclusively via the GridVis® software in the “Comparator” configuration area.

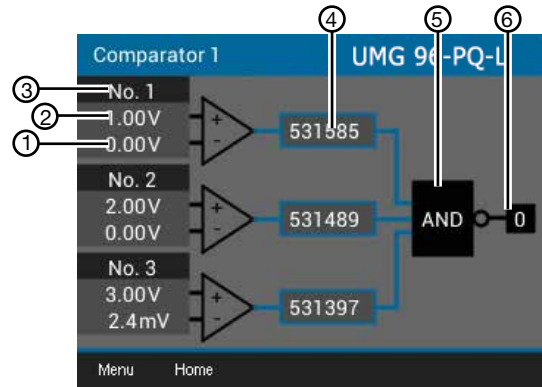

Fig. “Comparators” in the “Peripherals / Comparators” menu

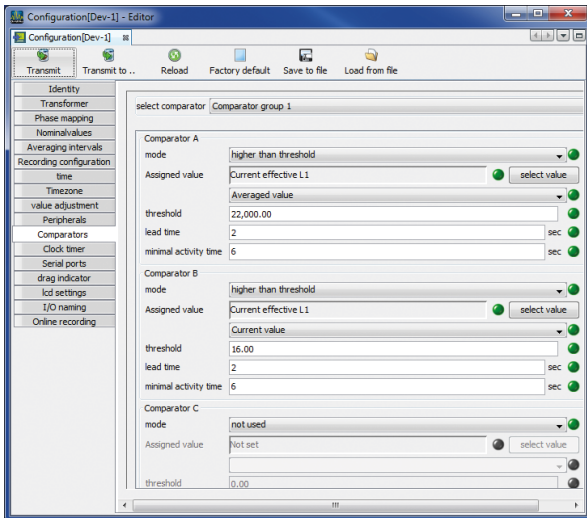

Fig. Configuration of the comparators in the GridVis® software

Read out comparator settings on the device:

- Open the menu with button 1.
- Use buttons 3 (▼) and 4 (▲) to select the item *Peripherals*.
- Confirm using button 6 (Enter).
- The submenu appears.
- Use buttons 3 (▼) and 4 (▲) to select the item *Comparator 1* for comparator group 1 and *Comparator 2* for comparator group 2.
- Confirm using button 6 (Enter).

Item	Function/Designation
1	Actual value
2	Limit value
3	Comparator
4	Comparator running time
5	Logic
6	Status

Tab.: Comparator entries

Comparator running time

Comparator running times are time counters that add up continuously for a set comparator output. This means that if the condition of the comparator is fulfilled and the lead time has expired, the counter increases by the corresponding amount of time. The minimum initialization time is not considered here!

Comparator with limit violation set

- The set limit value is compared with the measured value.
- If there is a limit violation for at least the duration of the lead time, the comparator result is changed.
- The result is retained at least for the duration of the minimum initialization time and at most for the duration of the limit violation. If there is no longer a limit violation and the minimum initialization time has expired, the result is reset.

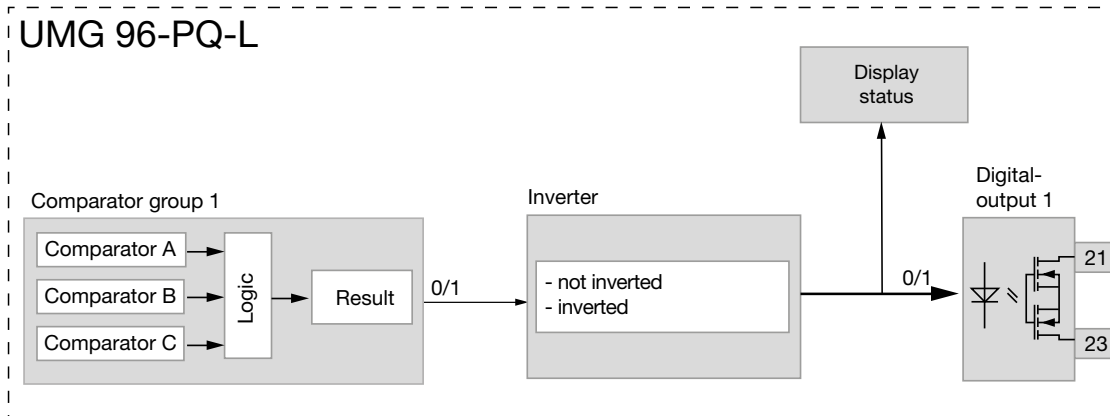
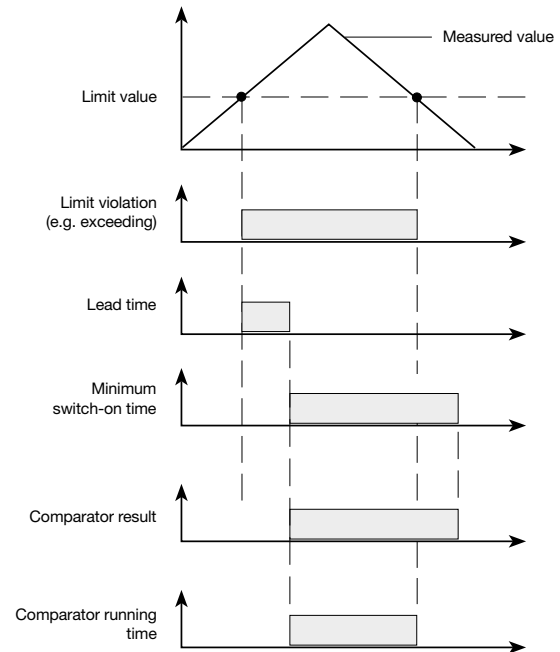

Fig. Block diagram "Use of digital output 2 for limit value monitoring"

13.15 Configuration of the analog output

The device has an analog output that can output a maximum current of 20 mA. An external 24 VDC power supply unit is required for operation.

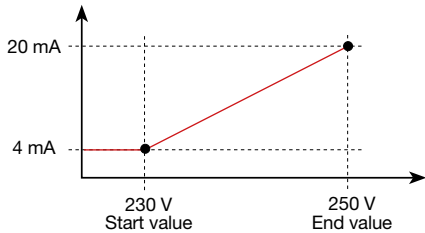

Fig. Principle of analog output with voltage monitoring

The configuration of the analog output can be carried out in a user-friendly manner using the GridVis® software. To do so, enter the assigned measured value, the start and end value and the output range in the device configuration under

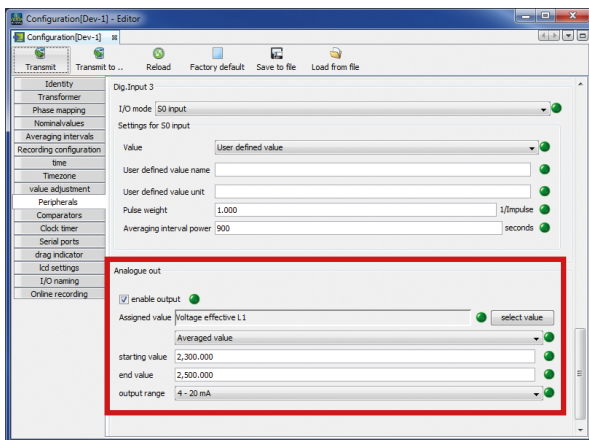

Fig. Configuration of the analog output in the GridVis® software

i INFORMATION

Information on configuring the analog output via the device keyboard can be found in section „12.7 Modbus editor“ on page 55.

“Peripherals”.

Examples:

Allocation of active power L1 (output range 4 - 20 mA)

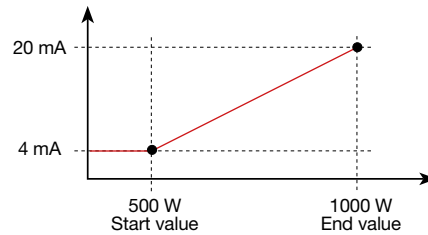

- With an active power of 500 W, the current at the analog output is 4 mA; with an active power of 1000 W --> 20 mA. The measured active power is proportional to the current at the analog output.

Assignment of the calculated active power factor $\cos \varphi$ (math.) (output range 4 - 20 mA).

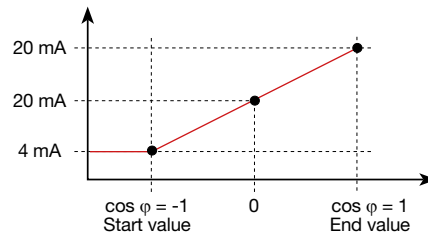

- Monitoring of the active power factor $\cos \varphi$ (math.) with:
 $\cos \varphi$ (math.) > 0 active power, applied.
 $\cos \varphi$ (math.) < 0 active power, delivered.

13.16 Drag indicator function

The “Drag indicator” function describes the 3 highest average values of value types over a defined period (time base).

- The device displays the measured maximum average values in the Drag Indicator menu (see section „13.16.4 Drag indicator - Measurement device displays“ on page 79).
- The average values determined can be called up via the GridVis® software and via a parameter with a time stamp.
- The period duration (time base), synchronization and capture time can be set in the GridVis® software or by setting the corresponding parameters.
- The average value calculation is made from the measured values of the following value types:
 - Current L1
 - Current L2
 - Current L3
 - Active power L1
 - Active power L2
 - Active power L3
 - Active power sum (L1...L3)
 - Apparent power L1
 - Apparent power L2
 - Apparent power L3
 - Apparent power sum (L1...L3)

Period duration (time base):

Individually configurable period duration in seconds for the calculation of the average values over this period (duration of measured value recording). If internal synchronization is selected, the average values are recalculated after the set period of time has elapsed.

Synchronization mode:

A synchronization determines a start time for the calculation periods of the average values.

You can optionally start a synchronization via

- the internal device clock (*internal synchronization*);
- the setting of a parameter (*via Modbus*);
- digital input 3 (*external synchronization*).

Capture time:

The individually configurable *Capture time* describes a time window in which an incoming pulse synchronizes the point in time. If the device receives a pulse outside the capture time, the calculated average values are deleted and the time is reset.

Note: The setting for the capture time – e.g. in the GridVis® software – describes half the time window of the total capture time!

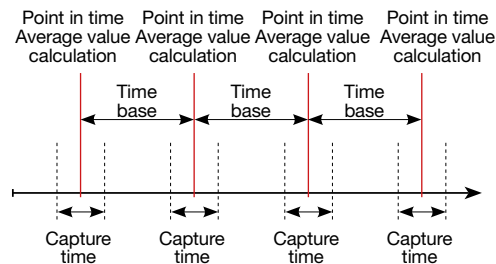

Fig. Principle of synchronization

13.16.1 Internal synchronization

The average values are calculated after the configurable period of time (time base) has expired. The internal synchronization takes place at the full minute if this is a multiple of the time base.

Time base [min]	Sync 1 (time)	Sync 2 (time)	Sync 3 (time)	Sync 4 (time)
2	09:00:00	09:02:00	09:04:00	09:06:00
5	09:00:00	09:05:00	09:10:00	09:15:00
15	09:00:00	09:15:00	09:30:00	09:45:00

Fig. Examples of internal synchronization with different time bases

i INFORMATION

For an *internal synchronization*, the options *Synchronization via Modbus* **AND** *Synchronization via digital output 3* must both be deactivated!

13.16.2 External synchronization

An external synchronization for the calculation of the 3 highest average values is performed:

- via digital input 3 (e.g. via a pulse generator) or
- via a Modbus command.

External synchronization scenarios:

“No pulse despite setting”

If there is no pulse via digital input 3 or a Modbus command, the measured values are stored as with an internal synchronization – but not only at each full minute!

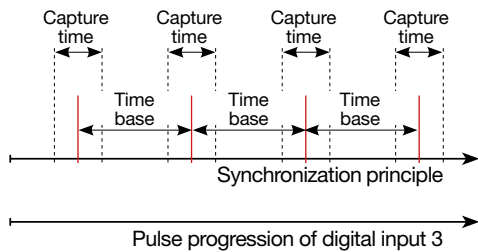

Fig. Principle of synchronization with “No pulse despite setting”

Example	Maximum value	Value	Time stamp
Effective current L1	Drag indicator 1	3.51 A	09:13:07
Effective current L1	Drag indicator 2	2.52 A	09:08:07
Effective current L1	Drag indicator 3	1.52 A	09:03:07

Fig. Example of drag indicator storage with a time stamp (with set time base of 5 min)

“One pulse”

If the device receives a pulse or a Modbus command once outside the capture time, the measured values added up to that point are reset for the calculation of the average value and the time. The time is redefined as a relative zero point and a new calculation is performed!

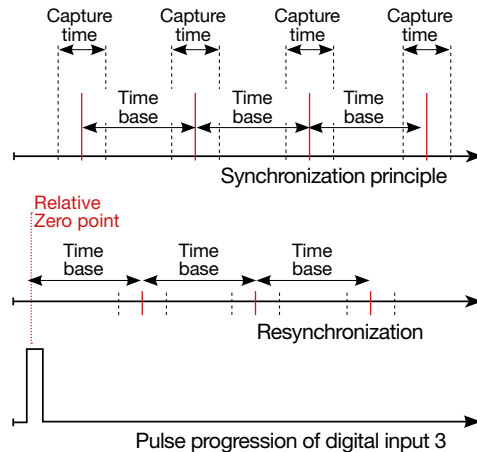

Fig. Principle of synchronization with “One impulse outside the capture time”

Example:

Example	Maximum value	Value	Time stamp
Active power L1	Drag indicator Consumption 1	396.73 W	09:18:47
Active power L1	Drag indicator Consumption 2	207.34 W	09:13:47
Active power L1	Drag indicator Consumption 3	80.59 W	09:08:47

Fig. Example of drag indicator storage with a time stamp (with set time base of 5 min)

The power increases with time. The values are reset to 0 by the pulse (09:06:47) outside the capture time. A new summation of the intermediate values begins from this point on. As no further impulse is received, the average value is calculated after the set time (time base).

“Periodic pulses”

If the device receives periodic pulses via digital input 3 or periodic Modbus commands, there are different scenarios.

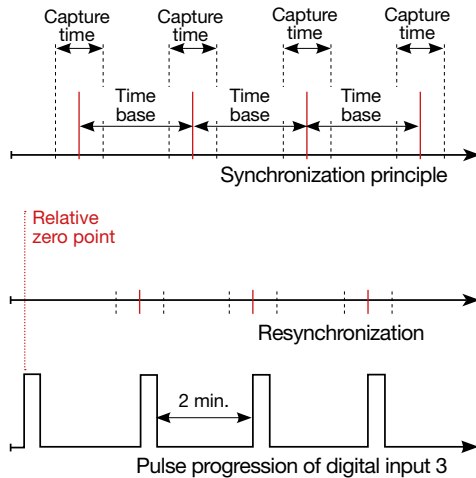
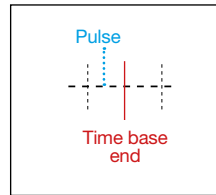

Fig. Principle of synchronization with “periodic pulses” to digital input 3

Scenario “Pulse before time base, within the capture time”:

- Perform value calculation now.
- The time is set to 0 (new relative zero point).
- Delete summed intermediate values.

***i* INFORMATION**

With periodic synchronization, the time is synchronized with each pulse!

Scenario “Pulse outside the capture time”:

- Summed intermediate values are set to 0.
- The time is set to 0 (new relative zero point).
- There is no value calculation.

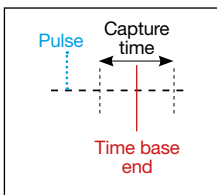
**Scenario “Pulse after time base, but within the capture time”:**

- Summed intermediate values are set to 0.
- The time is set to 0 (new relative zero point).
- There is no value calculation.

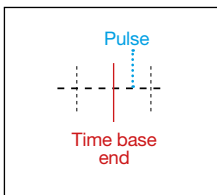

13.16.3 Synchronization priority

An external synchronization takes place according to different priorities:

- Priority 1:
Modbus synchronization
For this, set the “Enable flag” (addr.: 822) using the Modbus tool or select the “Synchronization via Modbus” option in the GridVis® software in the drag indicator configuration area.
- Priority 2:
Synchronization via digital input 3
For this, set the Modbus parameter “FUNC_SYNC_RECORD” (addr. 30048) to the value 4, or select the option “Drag indicator synchronization” in the GridVis® software in the peripherals (digital input 3) configuration area.
Note: Do NOT select the option “Synchronization via Modbus” in the drag indicator configuration!
- Priority 3:
Internal synchronization

Modbus address	Function	Configuration range
820	Set trigger flag for drag indicator synchronization	0 .. 1
821	Time base in seconds	60 .. 65535
822	Enable flag of the Modbus trigger	0 .. 1
823	Capture time in seconds	0 .. 255
30048	Configuration of the inputs	0 .. 4*

* 0 = FUNC_NONE;
1 = FUNC_TARIFF;
2 = FUNC_SYNC_CLOCK_MIN;
3 = FUNC_SYNC_CLOCK_H;
4 = FUNC_SYNC_RECORD

Fig. Table of Modbus addresses for a synchronization

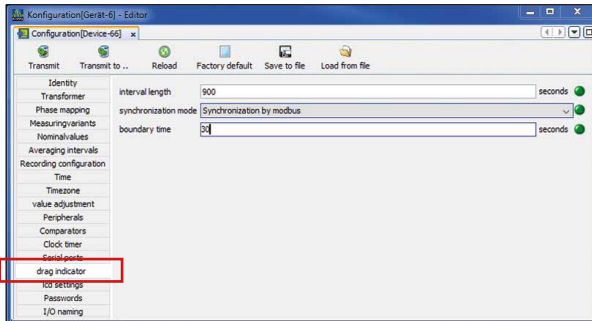

Fig. Drag indicator configuration in the GridVis® software

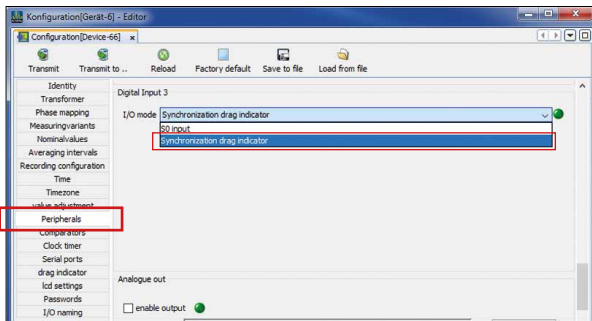

Fig. Configuration “Synchronization via digital input 3 in the GridVis® software”

13.16.4 Drag indicator - Measurement device displays

As already described in section “13.16 Drag indicator function”, the drag indicator function shows the **3 highest average values of value types over a defined period (time base)**.

The drag indicators of the respective measured value types can be called up on the measurement device display under *Menu > Drag indicator*. To do so, proceed as follows:

- If you are not in the start screen, you can go to this view by pressing button 2 (*Home*).

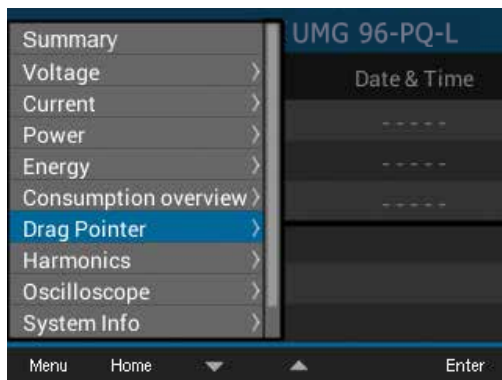

Fig. Drag indicator menu item

- Open the menu with button 1 (*Menu*).
- Use buttons 3 (▼) and 4 (▲) to select the item Drag indicator and confirm with button 6 (*Enter*).
- The submenu with the entries *Current*, *Active power* and *Apparent power* appears.



Fig. Drag indicator display with the submenu items *Current*, *Active power* and *Apparent power*.

- Use buttons 3 (▼) and 4 (▲) to select, for example, the item *Current* and then in the drop-down menu, for example, the item *L2*.
- Confirm using button 6 (*Enter*).
- The *Current L2* window appears with the following measured values:

Current L2		UMG 96-PQ-L	
Drag Pointer	Value	Date & Time	
1.	5.033A	27.07.20	11:38
2.	4.158A	27.07.20	11:40
3.	3.825A	27.07.20	11:37
Menu		Home	
		Delete	

Fig. Drag indicator display - *Current L2 (effective)* - of the 3 last maximum values with a time stamp.

In addition to the drag indicators of the **Currents L1, L2, L3**, the measurement device also shows you the drag indicators for **Active power** (applied and delivered) and **Apparent power - individually for phases L1, L2, L3 and for the totals L1 - L3**.

Active power Σ		UMG 96-PQ-L	
Drag Pointer	Value	Date & Time	
1. Con.	3487W	27.07.20	11:38
2. Con.	2886W	27.07.20	11:40
3. Con.	2201W	27.07.20	11:37
1. Del.	1395W	27.07.20	11:43
2. Del.	1395W	27.07.20	11:44
3. Del.	1188W	27.07.20	11:42
Menu		Home	
		Delete	

Fig. Drag indicator display - *active power sum (applied and delivered)* - of the last 3 maximum values with a time stamp.

Apparent pwr Σ		UMG 96-PQ-L	
Drag Pointer	Value	Date & Time	
1.	3487VA	27.07.20	11:38
2.	2886VA	27.07.20	11:40
3.	2201VA	27.07.20	11:37
Menu		Home	
		Delete	

Fig. Drag indicator display - *Apparent power sum* - of the last 3 maximum values with a time stamp.

13.16.5 Delete drag indicator

In each drag indicator display of the device - current, active and apparent power - a dialog box for deleting the drag indicator values appears when button 6 is pressed:

The screenshot shows the 'Active power Σ' screen of the UMG 96-PQ-L device. The main display is a table with three columns: 'Drag Pointer', 'Value', and 'Date & Time'. The table contains six rows of data, grouped into 'Con.' (Consolidation) and 'Del.' (Deletion) categories. A dialog box is overlaid on the table, showing 'Min./Max. values' and two buttons: 'Delete' and 'Cancel'. The 'Enter' button on the bottom right of the screen is highlighted with a red box.

Drag Pointer	Value	Date & Time
1. Con.	0.000W	14.07.20 10:50
2. Con.	0.000W	22.08.20 14:15
3. Con.	0.000W	22.08.20 14:55
1. Del.	0.000W	14.07.20 10:50
2. Del.	0.000W	22.08.20 16:15
3. Del.	0.000W	22.08.20 14:15

Fig. Dialog box for deleting the drag indicator values

i INFORMATION

The deletion of current, active power or apparent power drag indicator values of one phase also causes the deletion of the drag indicator values for the other phases of the respective category. If, for example, you delete the drag indicator "Current" of phase L1, the device also deletes the drag indicator "Current" for phases L2 and L3!

13.17 Recordings

You can configure measured value recordings for the measurement device easily and conveniently in the GridVis® software.

The default settings of the measurement device already include recording profiles (recording sets with integrated measured values) for 2 memory partitions:

- Memory **Partition A** = 4 recording sets.
- Memory **Partition B** = 3 recording sets.

Additional measured values can be added to the recording profiles of the default settings.

In the GridVis® software, you can configure up to 7 recording profiles (recording sets) per memory partition. Among other things, the recording sets cover the requirements of EN 50160, which defines and specifies measured values according to the characteristics of voltage in public electricity supply networks.

Further notes on configuration:

- The minimum averaging time for measured value recordings on memory partition A is 60 s (default setting, 600 s).

- The minimum averaging time for measured value recordings on memory partition B is 3 s (default setting, 600 s).
- The measurement device allows 7 recordings per partition with 30 measured values each.
- Within the recording configuration, measured values are defined via a time base according to the types Average value, Sample, Maximum or Minimum.
 - Average value type: Arithmetic mean value of the measured values over a defined period of time.
 - Maximum and Minimum type: Maximum or minimum values of a specified time period.
 - Sample type: Measured value at the end of the specified time period.

Note:

A recording of work values is only possible with the type Sample.

The following pages show the recording profiles (recording sets with integrated measured values) configured in the default settings of the measurement device. A detailed description of the measured value recordings can be found in the online help of the GridVis® software.

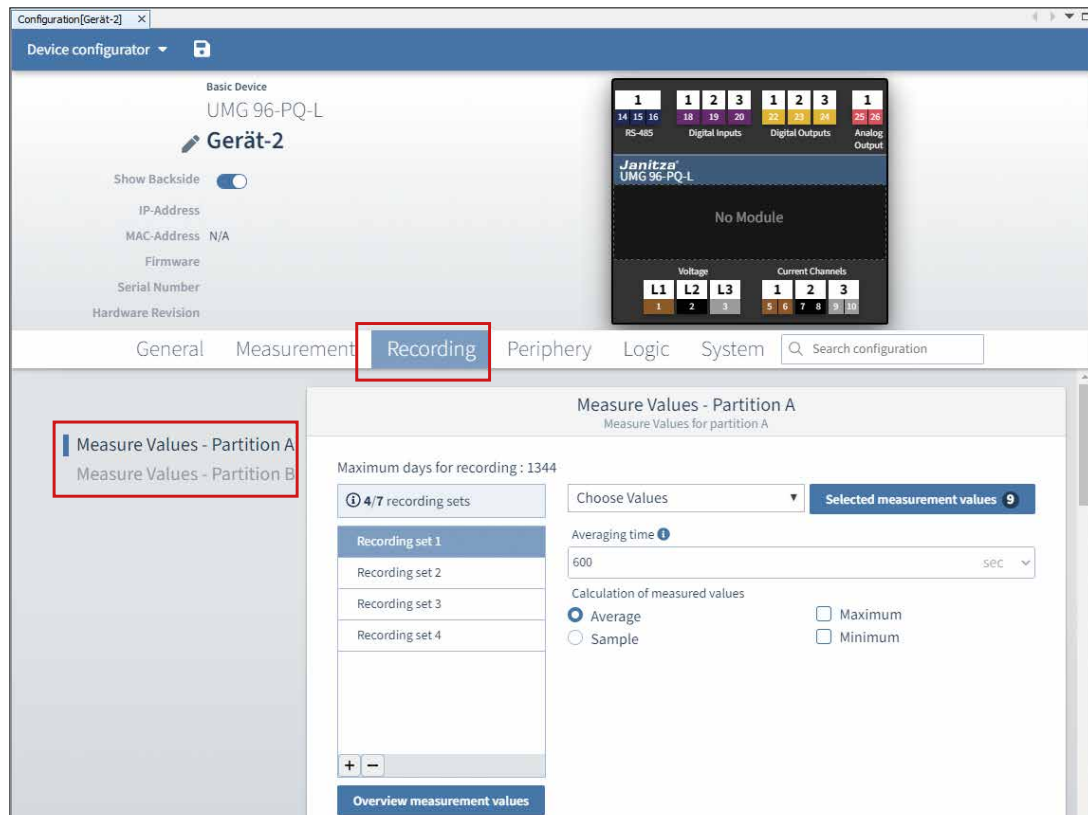

Fig. Recording configuration of memory partition A in the GridVis® software

i INFORMATION

Please note before configuration!

The lower the averaging time that is set, the greater the volume of data in the respective partitions of the measurement device and in the database of the GridVis® software. In this regard, note the indication of "Recording duration in days":

- High recording duration = low data volume.
- Low recording duration = high data volume.

A full partition has a data volume of 24 MB, and a readout via the RS-485 interface can take several hours.

Recommendation: Use the RCM-EL module for reading out large data volumes! Regular reading of your data does not require any action.

13.17.1 Default settings, memory partition A

The measurement device uses memory partition A for recording measured values relevant for energy management systems.

Recording profile 1 (9 measured values)

On the time base of 600 seconds (averaging time), the meter records the following measured values (arithmetic mean values):

- Effective voltage L1
- Effective voltage L1-L3
- Effective voltage L2
- Effective voltage L2-L1
- Effective voltage L3
- Effective voltage L3-L2
- THD voltage [%] L1
- THD voltage [%] L2
- THD voltage [%] L3

Recording profile 2 (20 measured values)

On the time base of 600 seconds (averaging time), the meter records the following measured values (arithmetic mean values):

- Reactive power fundamental oscillation L1
- Reactive power fundamental oscillation L2
- Reactive power fundamental oscillation L3
- Reactive power fundamental oscillation sum L1..L3
- Cos phi (math.) L1
- Cos phi (math.) L2
- Cos phi (math.) L3
- Cos phi (math.) Sum L1..L3
- Apparent power L1
- Apparent power L2
- Apparent power L3
- Apparent power, sum L1..L3
- Effective current L1
- Effective current L2
- Effective current L3
- Effective current, sum L1..L3
- Active power L1
- Active power L2
- Active power L3
- Active power, sum L1..L3

Recording profile 3 (4 measured values)

On the time base of 900 seconds (averaging time), the meter records the following measured values (sample):

- Active energy applied, overall tariff L1
- Active energy applied, overall tariff L2
- Active energy applied, overall tariff L3
- Active energy applied, overall tariff, sum L1..L3

Recording profile 4 (8 measured values)

On the time base of 3600 seconds (averaging time), the meter records the following measured values (sample):

- Active energy applied, overall tariff L1
- Active energy applied, overall tariff L2
- Active energy applied, overall tariff L3
- Active energy applied, overall tariff, sum L1..L3
- Inductive reactive energy, overall tariff L1
- Inductive reactive energy, overall tariff L2
- Inductive reactive energy, overall tariff L3
- Inductive reactive energy, overall tariff, sum L1..L3

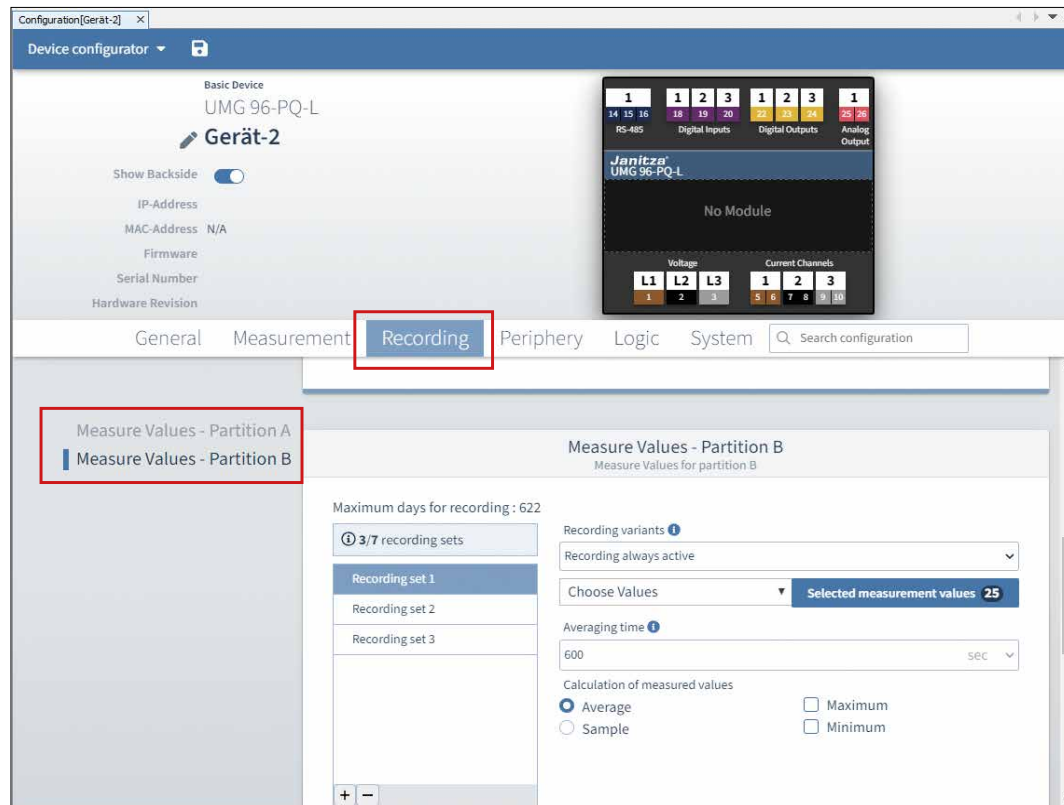

Fig. Recording configuration of memory partition B in the GridVis[®] software

13.17.2 Default settings, memory partition B

The meter uses memory partition B for recording measured values relevant for power quality (PQ – quality of supply).

The recording on memory partition B has 3 recording variants (configurable via the GridVis[®] software):

1. **Recording always active**
The meter records the selected measured values 24 hours a day, 7 days a week.
2. **Event triggered recording**
The meter starts recording when an event occurs and records the selected measured values for 15 min. If another event occurs during these 15 min, recording starts again. This recording variant is recommended for recording event-relevant measured values with a low time base.

3. Manually started/stopped recording

Start or stop the recording of the selected measured values with the Start/Stop button in the GridVis software or via Modbus register 533 (start = value 1, stop = value 2). This recording mode is recommended for recording many measured values at a low time base over a certain period of time.

Recording profile 1 (25 measured values)

On the time base of 600 seconds (averaging time), the meter records the following measured values (arithmetic mean values):

- 1st voltage harmonic, L1
- 2nd voltage harmonic, L1
- 3rd voltage harmonic, L1
- 4th voltage harmonic, L1
- 5th voltage harmonic, L1
- 6th voltage harmonic, L1
- 7th voltage harmonic, L1
- 8th voltage harmonic, L1
- 9th voltage harmonic, L1
- 10th voltage harmonic, L1
- 11th voltage harmonic, L1
- 12th voltage harmonic, L1
- 13th voltage harmonic, L1
- 14th voltage harmonic, L1

- 15th voltage harmonic, L1
- 16th voltage harmonic, L1
- 17th voltage harmonic, L1
- 18th voltage harmonic, L1
- 19th voltage harmonic, L1
- 20th voltage harmonic, L1
- 21st voltage harmonic, L1
- 22nd voltage harmonic, L1
- 23rd voltage harmonic, L1
- 24th voltage harmonic, L1
- 25th voltage harmonic, L1

Recording profile 2 (25 measured values)

On the time base of 600 seconds (averaging time), the meter records the following measured values (arithmetic mean values):

- 1st voltage harmonic, L2
- 2nd voltage harmonic, L2
- 3rd voltage harmonic, L2
- 4th voltage harmonic, L2
- 5th voltage harmonic, L2
- 6th voltage harmonic, L2
- 7th voltage harmonic, L2
- 8th voltage harmonic, L2
- 9th voltage harmonic, L2
- 10th voltage harmonic, L2
- 11th voltage harmonic, L2
- 12th voltage harmonic, L2
- 13th voltage harmonic, L2
- 14th voltage harmonic, L2
- 15th voltage harmonic, L2
- 16th voltage harmonic, L2
- 17th voltage harmonic, L2
- 18th voltage harmonic, L2
- 19th voltage harmonic, L2
- 20th voltage harmonic, L2
- 21st voltage harmonic, L2
- 22nd voltage harmonic, L2
- 23rd voltage harmonic, L2
- 24th voltage harmonic, L2
- 25th voltage harmonic, L2

Recording profile 3 (25 measured values)

On the time base of 600 seconds (averaging time), the meter records the following measured values (arithmetic mean values):

- 1st voltage harmonic, L3
- 2nd voltage harmonic, L3
- 3rd voltage harmonic, L3
- 4th voltage harmonic, L3
- 5th voltage harmonic, L3
- 6th voltage harmonic, L3
- 7th voltage harmonic, L3
- 8th voltage harmonic, L3
- 9th voltage harmonic, L3
- 10th voltage harmonic, L3
- 11th voltage harmonic, L3
- 12th voltage harmonic, L3
- 13th voltage harmonic, L3
- 14th voltage harmonic, L3
- 15th voltage harmonic, L3
- 16th voltage harmonic, L3
- 17th voltage harmonic, L3
- 18th voltage harmonic, L3
- 19th voltage harmonic, L3
- 20th voltage harmonic, L3
- 21st voltage harmonic, L3
- 22nd voltage harmonic, L3
- 23rd voltage harmonic, L3
- 24th voltage harmonic, L3
- 25th voltage harmonic, L3

13.17.3 Use cases – Recording examples

Use case 1

The meter is read out daily. Recording runs on both memory partitions 24 hours a day, 7 days a week. For example, the meter records the conventional measured values for energy management such as current, voltage, power, energy.

Use case 2

The meter is read out daily. In addition to the conventional measured values for energy management, measured values are to be recorded over specific time periods or on an event-driven basis with a low time base.

Application case 3

The meter is read out once a year (e.g. meters in distribution substations). The meter user uses both partitions in order to obtain a very high recording depth overall. This use case occurs, for example, with utilities that record for up to 4 years.

Application case 4

The meter is read out once a year (e.g. meters in distribution substations). For example, the meter user uses partition A for recording long-term data (approx. 1400 days) such as current, voltage, power, energy, THD and cos phi, plus partition B for PQ data such as the 1st - 65th harmonics (81 days). Thus, in addition to the recording of all long-term data, the meter user also has the PQ data for a possible error case retroactively for 81 days.

13.18 Internal and external events

The meter has the "Events" function for recording faults in the supply or power grid (**as of firmware 3.3**). The meter differentiates between internal and external events during detection:

- **Internal events** – direct triggering of event logging for:
 - Voltage interruption (U_{off})
 - Undervoltage (U_{min}).
 - Overvoltage (U_{max}).
 - Overcurrent (I_{max}).
- **External events** – triggering of event logging with a 20 s lead time and 20 s lag time via:
 - Modbus.
 - Digital inputs 1, 2 and 3.

An **internal event** exists when set limit values for current and voltage are exceeded or undershot. When doing so, the meter compares the set limit values with the **full-wave RMS values** from the measuring channels.

Event Type	Date & Time
All events	
Voltage interrupt.	06.10.21 16:48:30.660
Undervoltage	06.10.21 16:48:30.660
Overvoltage	06.10.21 16:48:30.660
Overcurrent	06.10.21 16:48:30.660
Ext. Modbus	06.10.21 16:48:30.660
Ext. Dig. In	06.10.21 16:48:30.660
UMIN	06.10.21 16:48:30.640
UMIN	06.10.21 16:48:30.640

Fig. Events submenu

i INFORMATION

You must configure all parameters for recording internal and external events for the UMG 96-PQ-L in the GridVis® software. The GridVis® software visualizes recorded events in an event browser (cf. Page 57).

- The meter captures
- The full-wave RMS values with a resolution of 20 ms for events.
 - 204.8 sample points per full wave at 50 Hz and 170.6 sample points at 60 Hz.
 - The type of event, the duration, the deviation, the date and the RMS value.
 - 6000 events "Qualitatively" and 200 "Quantitatively" and shows them in the display.

The meter initializes the event logging according to the configuration in the GridVis® software.

You must configure limit values and the hysteresis for **internal events** in percent of the nominal value for:

- The voltage interruption
- The undervoltage
- The bus overvoltage
- The bus overcurrent

If an event has occurred, the meter records the associated measured value with the **lead time (20 s) and lag time (20 s)** and the corresponding number of full waves.

The length of the RMS recording is determined by the number of full-wave RMS values up to the start of the event (lead time) and by the number of full-wave RMS values after the start of the event (lag time).

After a detected event, the meter display shows a sequence segment of the event in the time span of 2.5 s before and after the trigger time (cf. example 1 on Page 87).

In the case of longer events (> 20 s), the meter starts another recording sequence (with lead and lag time) at the end time of the event. The meter display does not show a sequence segment of the end time of the event (see example 2 on page 87)!

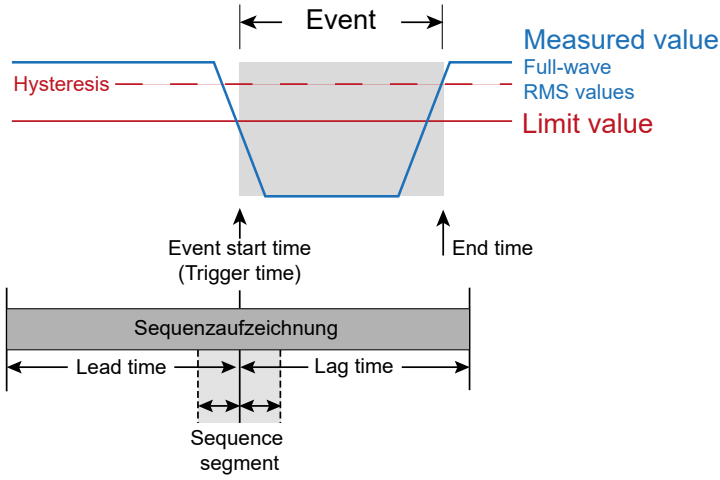

Example 1 of an event with sequence recording (lead and lag time) and a sequence segment (displayed visualization)

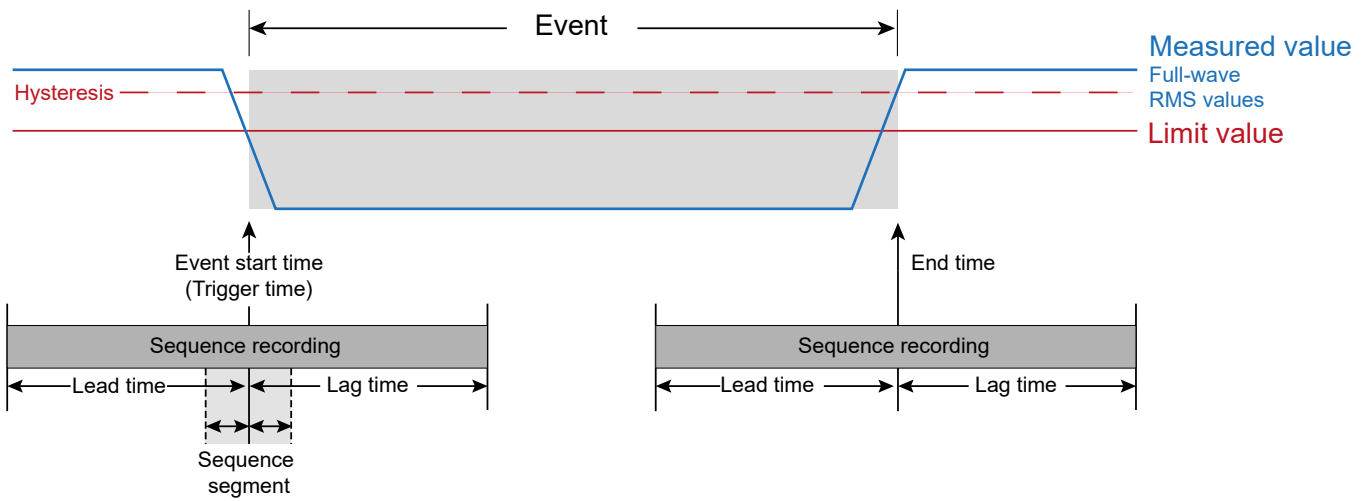

Example 2 of an event (> 20 s) with sequence recording (lead and lag time), sequence segment (displayed visualization) and sequence recording at the end time (lead and lag time)

The **external event logging via the digital inputs and via Modbus** starts with corresponding "triggers".

The **external event logging via Modbus** appears with a time stamp in the event list of the meter.

When a Modbus event occurs, the meter starts sequence recording, which provides 20 ms values with a lead and lag time of 20 s each for the current and voltage.

You must configure the external Modbus event in the GridVis® software or write a 1 to Modbus register 806.

The meter identifies an event via Modbus and displays it in the meter display as follows:

All events			UMG 96-PQ-L		
Phase	Events	Date & Time			
---	MODBUS	21.10.21 07:59:36,489			
---	MODBUS	21.10.21 07:59:29,801			
---	MODBUS	21.10.21 07:59:29,000			
---	MODBUS	20.10.21 12:51:28,947			
L1..L3	UMAX	19.10.21 15:09:52,859			
L3	UMAX	19.10.21 15:09:52,859			
Menu	Home				Enter

Fig. Event list – entries of the Modbus events.

The **external event logging via the digital inputs** appears with a time stamp in the event list of the meter.

- "triggers" the meter on a rising, falling or changing edge of the input signal.

You must configure the digital inputs in the GridVis® software (function mode of the digital inputs: External event logging) or in the following Modbus addresses:

Digital input	Modbus address	Entry (short)	Function
Dig. In. 1	30046	5	Rising edge
		6	Falling edge
		7	Changing edge
Dig. In. 2	30047	5	Rising edge
		6	Falling edge
		7	Changing edge
Dig. In. 3	30048	5	Rising edge
		6	Falling edge
		7	Changing edge

Modbus addresses for event configuration

The meter identifies an event at the corresponding digital input and displays it in the meter display as follows:

Ext. Dig. In			UMG 96-PQ-L Test		
Phase	Value	Date & Time			
---	Dig. In. 3	26.10.21 15:50:11,532			
---	Dig. In. 2	26.10.21 15:50:11,114			
---	Dig. In. 1	26.10.21 15:50:11,114			
---	Dig. In. 1	26.10.21 15:50:10,527			
---	Dig. In. 2	26.10.21 15:50:10,519			
---	Dig. In. 1	26.10.21 15:50:09,705			
Menu	Home				Enter

Fig. Event list – entries of the events on the respective digital input.

With "Event logging via the digital inputs", external devices that have a digital output send signals to the digital inputs of your meter.

This signal is sent, for example, by devices (signal generators) that detect voltage dips when loads such as capacitors, motors, etc. with high starting currents or inrush currents are added to circuits (cf. „9.1 Digital inputs“ on page 38).

13.19 Event lists

The meter records events in event lists for

- All events
- Voltage interruptions
- Undervoltage
- Overvoltage
- Overcurrent
- External Modbus event (Ext. Modbus)
- External digital input event (Ext. Dig. In)

The event list shows events (event types), if necessary on several display pages.

Proceed as follows to display and evaluate a specific event on the meter:

- If you are not in the start screen, you can go to this view by pressing button 2 (*Home*).
- Open the menu with button 1 (*Menu*).
- Use buttons 3 (▼) and 4 (▲) to select the item *Event* and confirm with button 6 (*Enter*).
- The submenu with the following event lists appears.

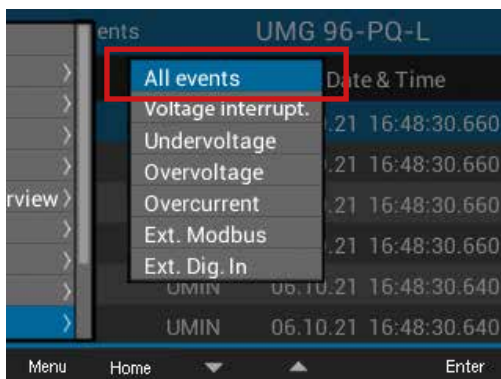

Fig. Events submenu

- Use buttons 3 (▼) and 4 (▲) to select your event type, e.g. the entry *All events*.
- Press button 6 (*Enter*).
- The *All events* window appears with an indication of the phase, event type, date and time of all events.

All events		UMG96-PQ-L-2700-0035	
Phase	Events	Date & Time	
L1..L3	UMIN	11.10.21	17:25:18,508
L3	UMIN	11.10.21	17:25:18,589
L2	UMIN	11.10.21	17:25:18,589
L1	UMIN	11.10.21	17:25:18,589
L1..L3	UMAX	11.10.21	17:25:18,508
L3	UMAX	11.10.21	17:25:18,589

Fig. Event list with all events

- To display and evaluate an event, use buttons 3 (▼) and 4 (▲) to select the corresponding event (hold down button 3 (▼) or 4 (▲)).
- Confirm the selected list entry with button 6 (*Enter*).
- The window for evaluation of your event appears (in the example, the sequence of an undervoltage event Umin).

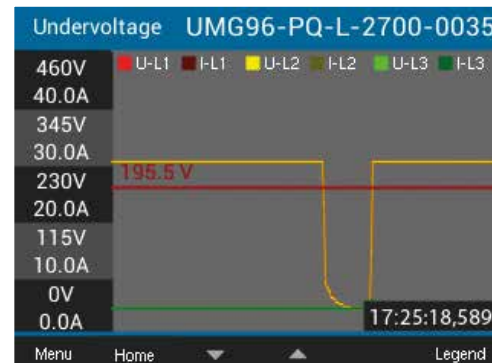

Fig. Sequence visualization of the undervoltage event

- Use button 6 (*Legend*) to show or hide the legend of the measuring channels.
- Use buttons 3 (▼) and 4 (▲) to switch the display to the previous or next event.
- Use button 1 (*Menu*) to go back through the displays step by step and button 2 (*Home*) to return to the start screen (*Overview*).

13.20 Tariff switching

The recording of electrical energy values (active, reactive and apparent energy) is done via internal meters for two tariffs each.

Switching between the tariffs (HT/LT) is supported by:

- Modbus,
- digital input 1 (see section “Digital inputs”) or
- the weekly timer (see section “Timer switch output”)

Tariff		UMG 96-PQ-L		
Tariff	Active E. [kWh]	Reactive E. [kVAh]	Apparent E. [kVAh]	
1	0	0	0	
2	0	10	10	
1 + 2	0	10	10	

Fig. Device display of the sum (L1..L3) of active, reactive and apparent energy according to tariffs

i INFORMATION

Configure tariff switching using the GridVis® software!

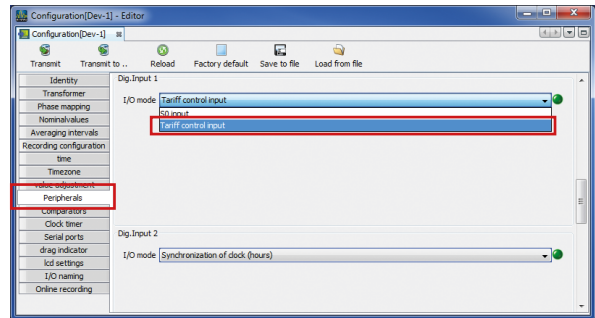

Fig. Configuration of digital input 1 as a tariff control input in the GridVis® software

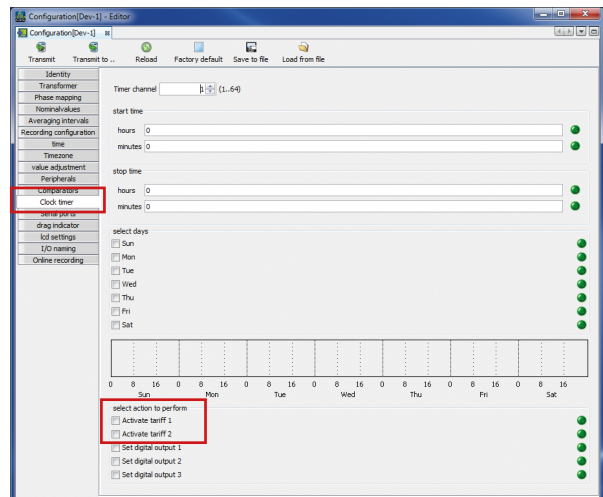

Fig. Timer configuration in the GridVis® software

13.21 Alarms for “Low battery voltage” and “Set time”

i INFORMATION

The device:

- Sets the time to the factory setting when the supply voltage is disconnected and the battery is simultaneously spent or after the battery is changed, meaning it is therefore considered “not set”!
- Saves correct data records only when the time is set!

To ensure that a battery change is carried out without loss of data, the device issues a warning with the alarm “**Battery voltage low**”:

Battery level low 10:05				
	Voltage	Current	Power	PF1
L1	223V	0.03A	0.00kW	1.00
L2	223V	0.03A	0.00kW	1.00
L3	223V	0.03A	0.00kW	1.00
L1..L3	50.06Hz	0.09A	0.00kW	1.00
Active energy		Reactive energy ind.		
L1..L3	0.0kWh		0.0kvarh	
Menu	Alarms			

Figures: Device alarm “Battery voltage low”

i INFORMATION

If the alarm “Battery voltage low” appears on the device display, replace the battery as described in the section „**16.6 Clock/Battery**“ on page 109!

After a battery replacement, an alarm appears on the device display stating “**Please set time**”.

Please set the time 10:00				
	Voltage	Current	Power	PF1
L1	223V	0.03A	0.00kW	1.00
L2	223V	0.03A	0.00kW	1.00
L3	223V	0.03A	0.00kW	1.00
L1..L3	50.06Hz	0.09A	0.00kW	1.00
Active energy		Reactive energy ind.		
L1..L3	0.0kWh		0.0kvarh	
Menu	Alarms			

Figures: Device alarm “Please set time”

Configure the time (date, time) as described in section 12.6 on page 51.

14. Overview of measuring displays

Use button 1 (*Menu*) of your meter to open the menu. The menu with the following items appears:

Summary	>
Voltage	>
Current	>
Power	>
Energy	>
Consumption overview	>
Drag Pointer	>
Harmonics	>
Oscilloscope	>
Events	>
System Info	>
Configuration	>

To access the measuring displays, use buttons 3 (▼) and 4 (▲) to select the corresponding menu item and confirm with button 6 (*Enter*).

i INFORMATION

A graphical presentation of the menu structure can be found in section „11.4 Overview of menu displays“ on page 42

14.1 Menu overview (Start screen)

Network analysis (Start screen)

Summary		UMG 96-PQ-L			
	Voltage	Current	Power	PF1	
L1	223V	0.03A	0.00kW	1.00	
L2	223V	0.03A	0.00kW	1.00	
L3	223V	0.03A	0.00kW	1.00	
L1..L3	50.06Hz	0.09A	0.00kW	1.00	
Active energy		Reactive energy ind.			
L1..L3	0.0kWh		0.0kvarh		
Menu					

Three-phase 4-conductor system: Display of

- Voltage L1-N, L2-N, L3-N, frequency;
- Current L1, L2, L3 and sum of L1..L3;
- Power L1, L2, L3 and sum of L1..L3;
- Power factor and sum of L1..L3;
- Sum of active and reactive energy L1-L3

Summary		UMG 96-PQ-L			
	Voltage	Current	Power	PF1	
L1-L2	0V	0.000A	---	---	
L2-L3	0V	0.000A	---	---	
L3-L1	0V	0.000A	---	---	
L1..L3	50.00Hz	0.000A	0.00kW	1.00	
Active energy		Reactive energy cap.			
L1..L3	-0.0kWh		0.0kvarh		
Menu					

Three-phase 3-conductor system: Display of

- Voltage L1-L2, L2-L3, L3-L1, frequency;
- Current L1, L2, L3 and vectorial sum of L1..L3;
- Sum values: Power; power factor; active and reactive energy L1-L3

14.2 Voltage menu

Voltage L-N

Voltage		UMG 96-PQ-L		
	Value	Minimum	Maximum	
L1-N	223.2V	1.7V	223.5V	
L2-N	223.1V	1.7V	223.4V	
L3-N	223.2V	1.7V	223.5V	
Menu	Home			Min/Max

Display of voltage L1-N, L2-N, L3-N and their min. / max. values

Voltage L-L

Voltage		UMG 96-PQ-L		
	Value	Minimum	Maximum	
L1-L2	1.3V	0.1V	223.8V	
L2-L3	2.0V	0.1V	223.7V	
L1-L3	0.0V	0.0V	0.0V	
Menu	Home			Min/Max

Display of voltage L1-L2, L2-L3, L1-L3 and their min. / max. values

History

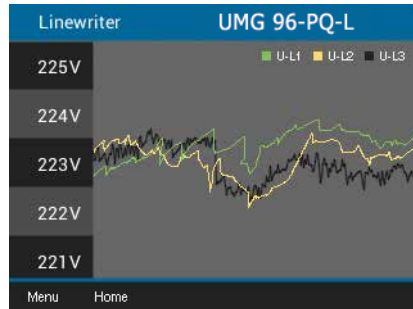

Display of voltage history of L1-N, L2-N, L3-N

Phasor diagram (star) (Three-phase 4-conductor system)

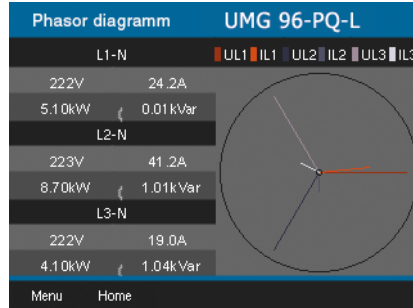

Display of voltage history of L1-N, L2-N, L3-N

Phasor diagram (triangle) (Three-phase 3-conductor system)

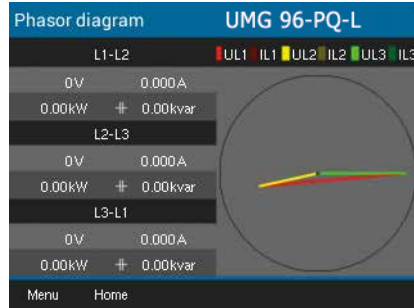

Display of voltage history of L1-L2, L2-L3, L3-L1

14.3 Current menu

Current

Current		UMG 96-PQ-L	
	Value	Max. avg.	Max.
L1	0.03 A	0.0 A	0.0 A
L2	0.03 A	0.0 A	0.0 A
L3	0.02 A	0.0 A	0.0 A

Display of current L1, L2, L3 and their min. / max. values

THD-I

THD I		UMG 96-PQ-L	
	Value	Minimum	Maximum
L1	16.19%	15.84%	16.43%
L2	16.19%	15.78%	16.46%
L3	16.23%	15.82%	16.41%

Display of distortion factors for the current (THD-I) L1, L2, L3 and their min. / max. values

History

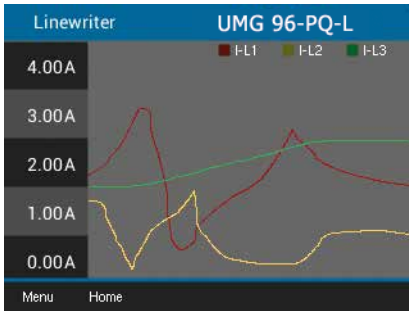

Display of current histories L1, L2, L3

14.4 Power menu

Total power

Power		UMG 96-PQ-L	
	Value	Minimum	Maximum
P	-0.1 W	-0.1 W	0.1 W
Q	19.6 VAr	0.0 VAr	19.7 VAr
S	19.9 VA	0.1 VA	23.1 VA

Displays sum (L1..L3) of active, reactive and apparent power and their min./max. values

Active / reactive / apparent power (Three-phase 4-conductor system only)

Active power		UMG 96-PQ-L	
	Value	Minimum	Maximum
L1	-0.0 W	-0.0 W	0.5 W
L2	-0.0 W	-0.5 W	0.0 W
L3	-0.0 W	-0.0 W	0.0 W

Display of power values (active, reactive or apparent power) L1-N, L2-N, L3-N and their min./ max. values

History of active / reactive / apparent power

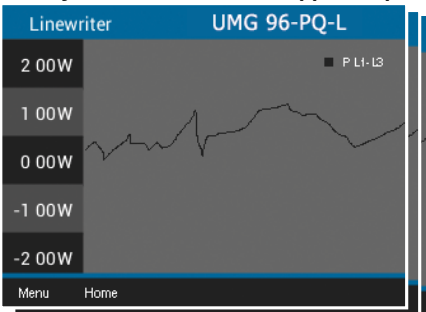

Displays the history of active, reactive or apparent power (sum L1..L3)

14.5 Energy menu

Active, reactive, apparent energy

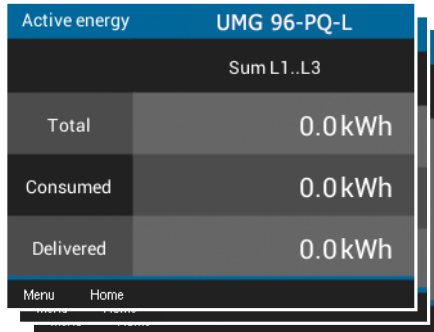

Displays sum (L1..L3) of active, reactive and apparent energy

Tariff

Tariff UMG 96-PQ-L			
Tariff	Active en. [kWh]	Reactive en. [kvarh]	Apparent en. [kVAh]
1	0	0	0
2	0	0	0
1 + 2	0	0	0

Displays the sum (L1..L3) of active, reactive and apparent energy according to tariffs

14.6 Consumption overview menu

Active, reactive, apparent energy / Daily

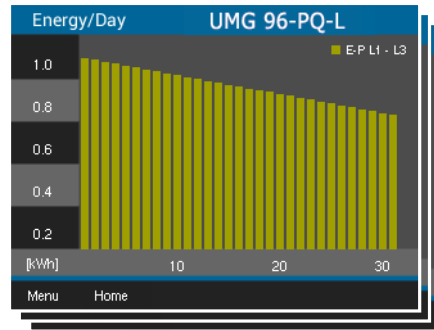

Display of the active, reactive or apparent energy "Daily" (per day of the current month)

Active, reactive, apparent energy / Monthly

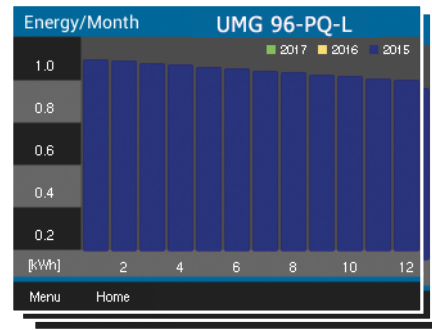

Display of the active, reactive or apparent energy "Monthly" (per month of the last three years)

14.7 Drag indicator menu

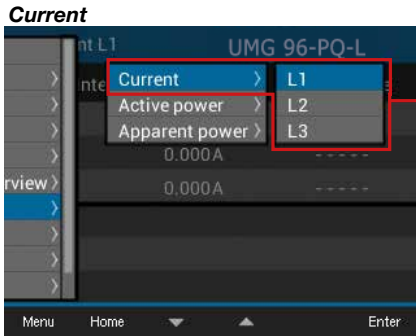

Current L1, L2, L3

Current L1		UMG 96-PQ-L	
Drag Pointer	Value	Date & Time	
1.	5.033A	27.07.20	11:38
2.	4.158A	27.07.20	11:40
3.	3.825A	27.07.20	11:37

Menu Home Delete

Drag indicator display of the currents L1, L2 and L3 with the 3 maximum values and a time stamp.

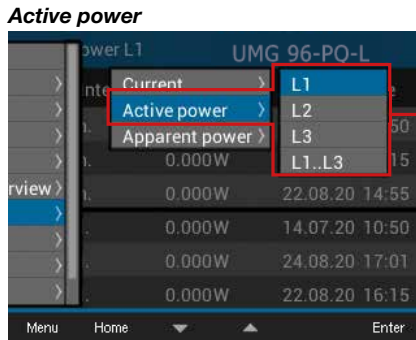

Active power (Appl. and Del.) L1, L2, L3

Active power L1		UMG 96-PQ-L	
Drag Pointer	Value	Date & Time	
1. Con.	1395W	14.07.20	10:50
2. Con.	1188W	01.08.20	09:58
3. Con.	0.000W	-----	
1. Del.	395W	14.07.20	10:50
2. Del.	270W	01.08.20	09:58
3. Del.	0.000W	-----	

Menu Home Delete

Drag indicator display of the active powers L1, L2 and L3 (App. and Del.) with the 3 maximum values and a time stamp.

Active power sum (Appl. and Del.) L1..L3

Active power Σ		UMG 96-PQ-L	
Drag Pointer	Value	Date & Time	
1. Con.	3487W	27.07.20	11:38
2. Con.	2886W	27.07.20	11:40
3. Con.	2201W	27.07.20	11:37
1. Del.	1395W	27.07.20	11:43
2. Del.	1395W	27.07.20	11:44
3. Del.	1188W	27.07.20	11:42

Menu Home Delete

Drag indicator display of the active power sum L1..L3 (App. and Del.) with the 3 maximum values and a time stamp.

Apparent power



Apparent power L1, L2, L3

Apparent pwr L1 UMG 96-PQ-L		
Drag Pointer	Value	Date & Time
1.	739VA	27.07.20 11:38
2.	818VA	27.07.20 11:40
3.	737VA	27.07.20 11:37

Drag indicator display of the apparent powers L1, L2 and L3 with the 3 maximum values and a time stamp.

Apparent power, sum L1..L3

Apparent pwr Σ UMG 96-PQ-L		
Drag Pointer	Value	Date & Time
1.	3487VA	27.07.20 11:38
2.	2886VA	27.07.20 11:40
3.	2201VA	27.07.20 11:37

Drag indicator display of the apparent power sum L1..L3 with the 3 maximum values and a time stamp.

14.8 Harmonics menu

Voltage L1 / L2 / L3

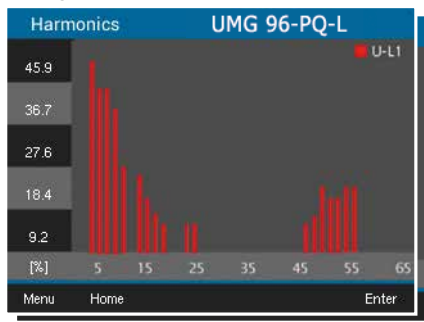

Display of the harmonics up to the 65th harmonic (voltage L1, L2, L3)

Current L1, L2, L3

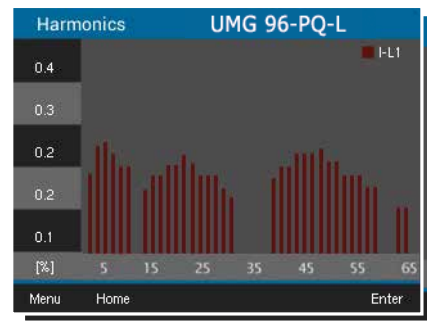

Display of the harmonics up to the 65th harmonic (current L1, L2, L3)

14.9 Oscilloscope menu

Voltage L1 / L2 / L3

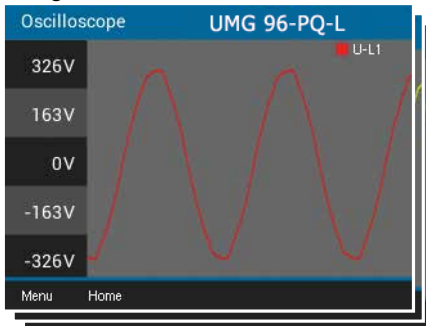

Display oscillogram of voltage L1, L2 or L3

Voltage L1..L3

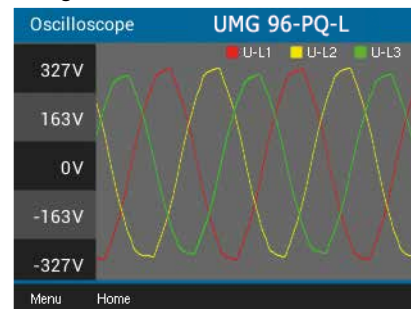

Display oscillogram of voltages L1, L2 and L3

Current L1, L2, L3

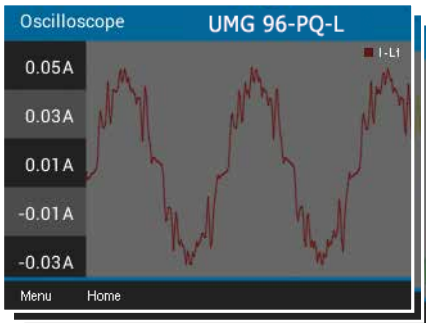

Display oscillogram of the currents L1, L2 or L3

Current L1..L3

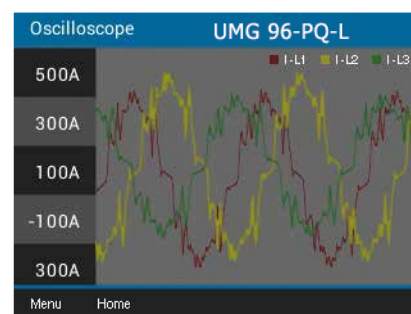

Display oscillogram of the currents of L1, L2 and L3

14.10 Events menu

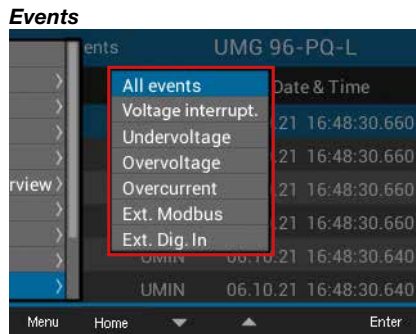

i INFORMATION

Please note:

Depending on the configured **connection variant** (cf. section „12.4.2 Connection variant“ one page 47), the meter has different displays for events and sequences.

All events

Phase	Events	Date & Time
L1..L3	UMIN	11.10.21 17:25:18,508
L3	UMIN	11.10.21 17:25:18,589
L2	UMIN	11.10.21 17:25:18,589
L1	UMIN	11.10.21 17:25:18,589
L1..L3	UMAX	11.10.21 17:25:18,508
L3	UMAX	11.10.21 17:25:18,589

Menu Home Enter

Display list of all events in the three-phase 4-wire system

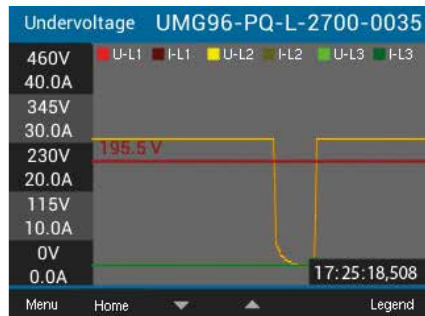

Display – sequence of an undervoltage in the three-phase 4-wire system

All events

Phase	Events	Date & Time
---	MODBUS	02.11.21 14:20:24,000
L1..L3	UMAX	02.11.21 14:13:07,960
L3-L1	UMAX	02.11.21 14:13:07,960
L2-L3	UMAX	02.11.21 14:13:07,960
L1-L2	UMAX	02.11.21 14:13:07,960

Menu Home Enter

Display list of all events in the three-phase 3-wire system



Display – sequence of an overvoltage in the three-phase 3-wire system

Voltage interruption event

Voltage interrupt. UMG96-PQ-L-2700-0035		
Phase	Value	Date & Time
L1..L3	9.8 V	11.10.21 17:25:10,520
L3	6.9 V	11.10.21 17:25:10,520
L2	7.1 V	11.10.21 17:25:10,500
L1	7.1 V	11.10.21 17:25:10,500
L1..L3	10.6 V	11.10.21 17:08:40,200
L3	3.8 V	11.10.21 17:08:40,200

Display list of voltage interruptions

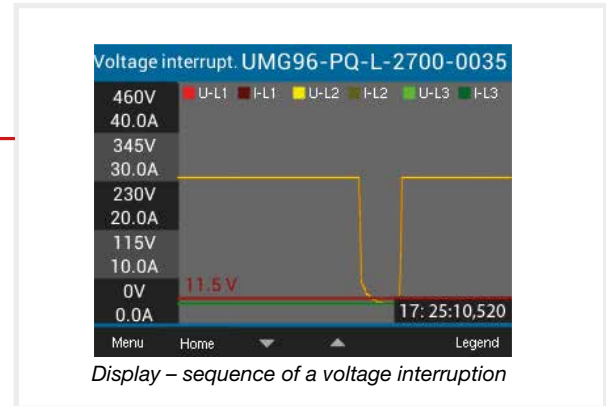

Display – sequence of a voltage interruption

Undervoltage event

Undervoltage UMG96-PQ-L-2700-0035		
Phase	Value	Date & Time
L1..L3	165.0 V	11.10.21 17:25:18,589
L3	68.7 V	11.10.21 17:25:18,589
L2	68.1 V	11.10.21 17:25:18,589
L1	68.1 V	11.10.21 17:25:18,589
L1..L3	110.6 V	11.10.21 17:25:13,527
L3	68.9 V	11.10.21 17:25:13,527

Display list of the undervoltage events

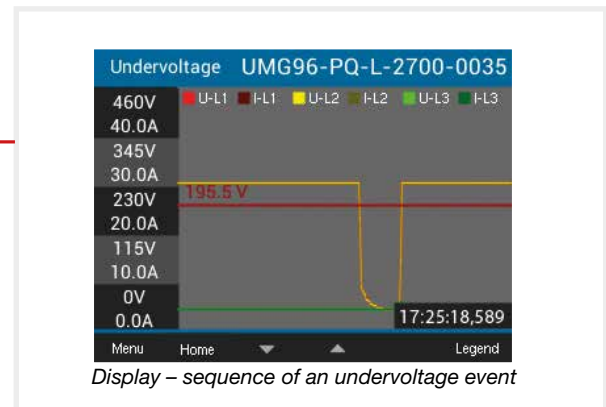

Display – sequence of an undervoltage event

Overvoltage event

Overvoltage UMG 96-PQ-L		
Phase	Value	Date & Time
L3	259.7 V	28.10.21 11:03:14,939
L2	259.6 V	28.10.21 11:03:14,939
L1	260.0 V	28.10.21 11:03:14,939
L1..L3	260.0 V	28.10.21 10:59:14,940
L3	259.9 V	28.10.21 10:59:14,940
L2	259.9 V	28.10.21 10:59:14,940

Display list of the overvoltage events

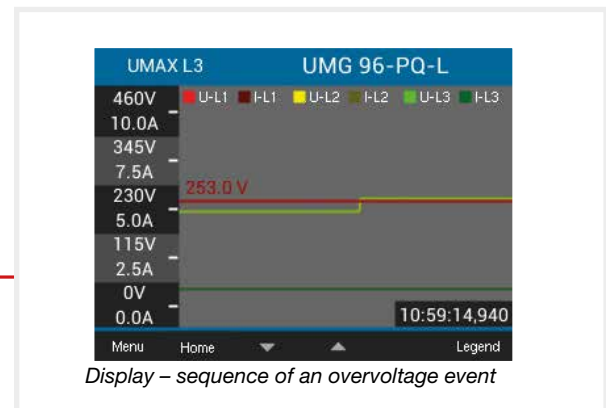

Display – sequence of an overvoltage event

Overcurrent event

Overcurrent UMG 96-PQ-L		
Phase	Value	Date & Time
L1..L3	6.00 A	28.10.21 11:12:10,340
L3	5.92 A	28.10.21 11:12:10,340
L1	5.84 A	28.10.21 11:12:10,340
L2	6.00 A	28.10.21 11:12:10,340
L1..L3	6.00 A	28.10.21 11:10:10,340
L3	6.00 A	28.10.21 11:10:10,340

Display list of all overcurrent events

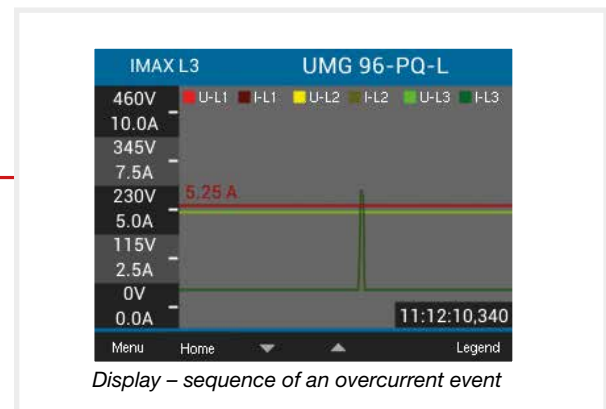

Display – sequence of an overcurrent event

Ext. Modbus event

Ext. Modbus UMG96-PQ-L-2700-0035		
Phase	Value	Date & Time
---	---	11.10.21 17:15:11,411
---	---	11.10.21 17:15:09,489
---	---	11.10.21 17:15:07,476
---	---	11.10.21 17:14:49,000

Display list of the ext. Modbus events

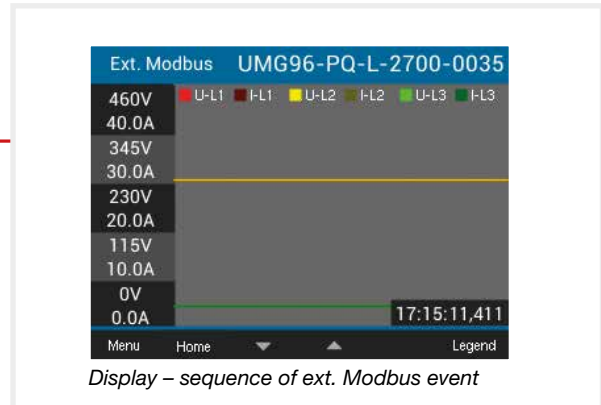

Display – sequence of ext. Modbus event

Ext. digital input event

Ext. Dig. In UMG96-PQ-L-2700-0035		
Phase	Value	Date & Time
---	Dig. In. 0	11.10.21 17:20:10,039
---	Dig. In. 0	11.10.21 17:20:10,039
---	Dig. In. 0	11.10.21 17:19:29,039
---	Dig. In. 0	11.10.21 17:19:29,039
---	Dig. In. 0	11.10.21 17:18:43,039
---	Dig. In. 0	11.10.21 17:18:43,039

Display list of ext. dig. inputs events

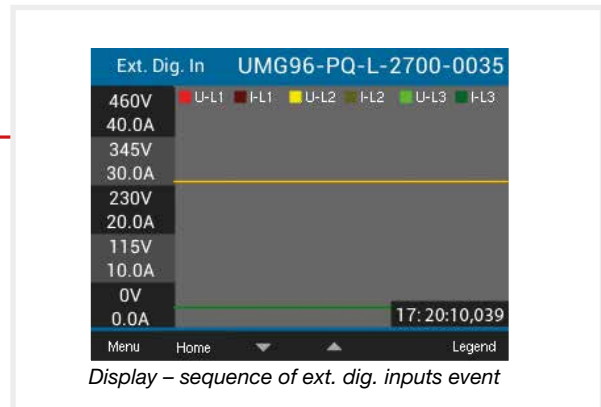

Display – sequence of ext. dig. inputs event

14.11 System Info menu

System Info submenu

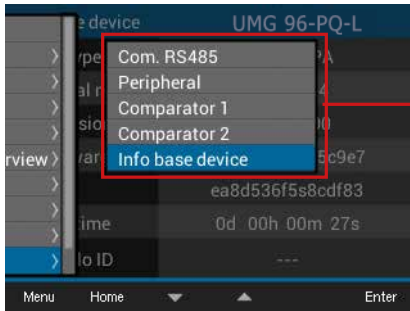

Com. RS-485

Com. RS485		UMG 96-PQ-L		
	RX	TX	Error	
RS485	0	0	0	
RS485 Mode	Modbus			
Device address	1			
Baud rate	115200			
Timeout	350 ms			

Display of received (RX), transmitted (TX) and faulty data packets, RS-485 mode, device address, baud rate and timeout.

Peripherals

Peripheral		UMG 96-PA		
I/O	No. 1	No. 2	No. 3	
Digital in	LOW	LOW	LOW	
Digital out	LOW	HIGH	LOW	
Analog out	0.0mA			

Display of the states of the digital inputs and outputs, value of the analog output.

Comparator 1

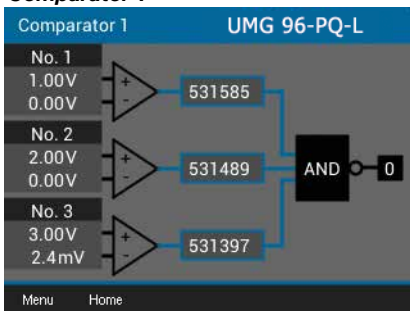

Display of limit value, actual value, comparator running time, logic and status.

Comparator 2

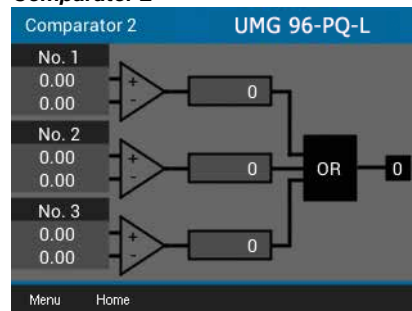

Display of limit value, actual value, comparator running time, logic and status.

Basic device info

Info base device		UMG 96-PQ-L	
Type	UMG 96-PA		
Serial no.	43001234		
Version	3.00 / 4.00		
Software ID	54e134f86a75c9e7		
	ea8d536f5s8cdf83		
Uptime	0d 00h 02m 47s		
Malo ID	---		

Device type, serial number, firmware version, software ID, running time and Malo ID.

15. Overview of displays in the Configuration menu

i INFORMATION

For advanced information on the items in the Configuration menu, see chapter „12. Configuration“ one page 44.

15.1 Language submenu

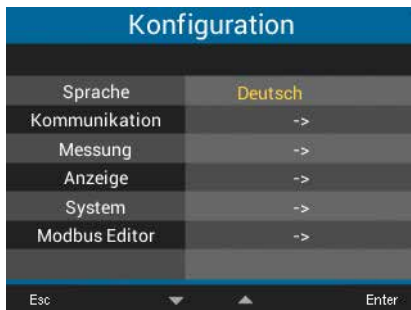
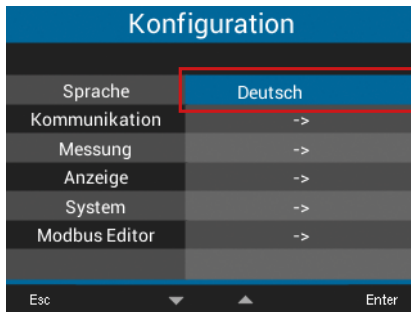

Setting the language to German.

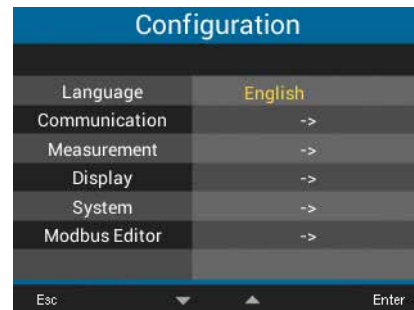

Setting the language to English.

15.2 Communication submenu

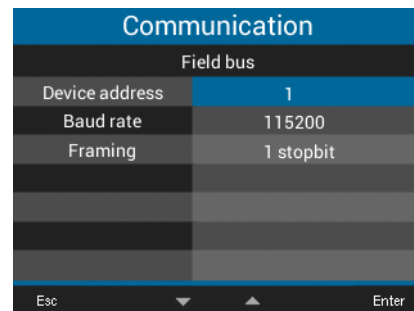
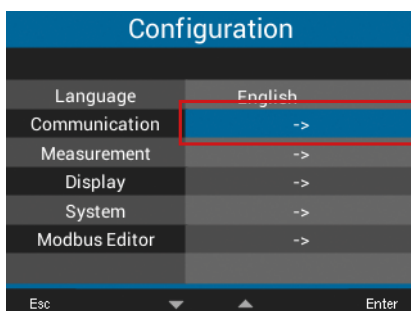

Fieldbus settings device address, baud rate and data frame.

15.3 Measurement submenu

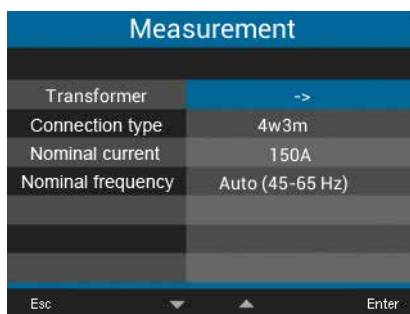
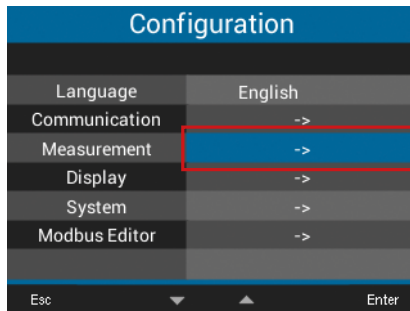

Settings of the transformers, the nominal current and the nominal frequency.

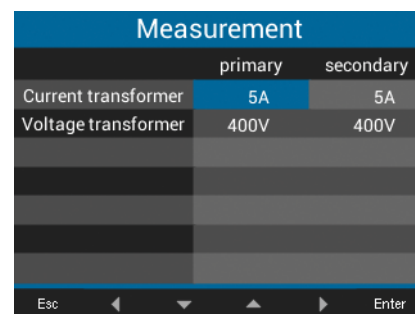

Settings of current and voltage transformers (primary and secondary).

15.4 Display submenu

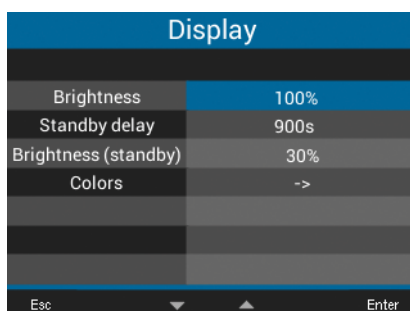
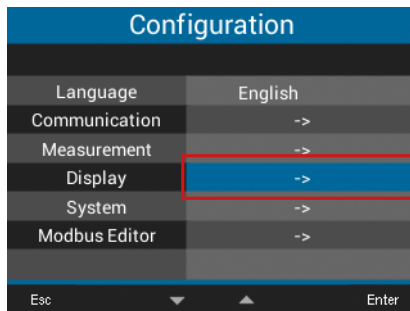

Settings for brightness, standby time after, brightness (standby) and the display colors for voltage and current (L1, L2, L3).



Settings for the display colors of voltage and current (L1, L2, L3).

15.5 System submenu

Configuration	
Language	English
Communication	->
Measurement	->
Display	->
System	->
Modbus Editor	->

System	
Version	3.00 / 4.00
Serial no.	43000009
Time	08.11.18 09:22:09
Password	00000
Reset	->

Firmware version, serial number. Setting the time, password and resetting measured values.

Reset	
Energy	No
Min./Max. values	No
Factory settings	No
Restart	No

Resetting of energy measured values, min. and max. values. Reset to standard factory settings or restart of the measurement device.

15.6 Modbus editor submenu

Configuration	
Language	English
Communication	->
Measurement	->
Display	->
System	->
Modbus Editor	->

Communication	
Modbus Editor	
Address	30001
Value	0
Minimum	0
Maximum	65535
Type	short
Access	read/write

Settings for the Modbus addresses (address, value).

16. Service and maintenance

Prior to outbound delivery, the device is subjected to various safety tests and is marked with a seal. If a device is opened, the safety tests must be repeated. A warranty is only assumed for unopened devices.

16.1 Repair and calibration

Repair and calibration of the device must only be carried out by the manufacturer or an accredited laboratory! The manufacturer recommends calibrating the device every 5 years!



WARNING

Warning of unauthorized tampering or improper use of the device.

Opening, dismantling or unauthorized manipulation of the device which goes beyond the mechanical, electrical or other operating limits indicated can lead to material damage or injury, up to and including death.

- Only electrically qualified personnel are permitted to work on the devices and their components, assemblies, systems and current circuits!
- Always use your device or component only in the manner described in the associated documentation.
- In the event of visible damage, or for the purpose of repair and calibration, return the device to the manufacturer!

16.2 Front panel foil and display

Please note the following for the care and cleaning of the front foil and the display:

INFORMATION

Material damage due to improper care and cleaning of the device.

The use of water or other solvents, such as denatured alcohol, acids, acidic agents for the front foil or the display can damage or destroy the device during cleaning. Water can, for example, penetrate into the device housing and destroy the device.

- Clean the device, the front foil or the display with a soft cloth.
- Use a cloth moistened with clear water for heavy soiling.
- Clean the front panel foil and the display, e.g. fingerprints, with a special LCD cleaner and a lint-free cloth.
- Do not use acids or acidic agents to clean the devices.

16.3 Service

For questions not answered or described in this manual, please contact the manufacturer. Please be certain to have the following information ready to answer any questions:

- Device designation (see rating plate)
- Serial number (see rating plate)
- Software release (see system display)
- Measured voltage and supply voltage
- An exact error description.

16.4 Device adjustment

The manufacturer adjusts the devices before delivery. No readjustment is required when the environmental conditions are complied with.

16.5 Firmware update

For a firmware update, connect your device to a computer and obtain access via the **GridVis®** software:

- Open the Firmware Update Wizard by clicking on “Update Device” in the “Extras” menu.
- Select your update file and perform the update.

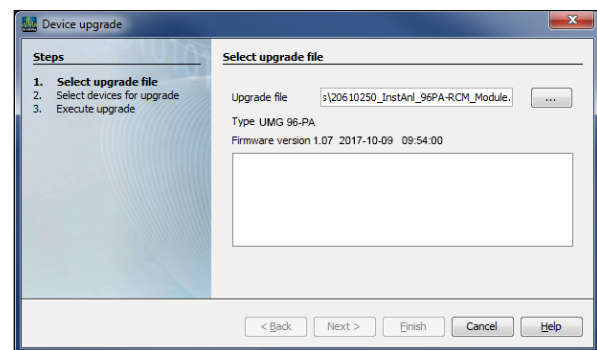

Fig. Updating the device firmware in the GridVis® software

16.6 Clock/Battery

The supply voltage supplies the internal clock of the meter. If the supply voltage fails, the battery takes over the supply of voltage to the clock. The clock provides date and time information, for example for recordings and min. and max. values.

INFORMATION

The device:

- Saves correct data records only when the time is set!
- Sets the time to the factory setting when the supply voltage is disconnected and the battery is simultaneously spent or after the battery is changed, meaning it is therefore considered “not set”.

The life expectancy of the battery is at least 5 years at a storage temperature of +45° C. The typical battery life is 8 to 10 years.

The battery can be replaced via the battery insert on the bottom of the device. **When replacing the battery, make sure that the battery type and polarity are correct** (positive pole points to the rear of the device; negative pole points to the front of the device)!

Pay attention to the following when replacing the battery:



WARNING

Risk of injury due to electrical voltage!

Severe bodily injury or death can result from:

- Touching bare or stripped leads that are energized.
- Device inputs that pose a hazard when touched.

Observe the following when handling your device and when changing the battery, before starting work:

- Disconnect the system/device from the power supply!
- Secure it against being switched on!
- Check to be sure it is de-energized!
- Ground and short circuit!
- Cover or block off adjacent live parts!

INFORMATION

Grease or dirt on the contact surfaces forms a contact resistance which shortens the service life of the battery. Only touch the battery by the edges.

17. Procedure in the event of a malfunction

Failure mode	Cause	Remedy
No display	External fuse for the supply voltage has tripped.	Replace fuse.
No current display.	No measured voltage connected.	Connect measured voltage.
	No measured current connected.	Connect measured current.
Displayed current is too great or too small.	Current measurement on the wrong phase.	Check connection and correct if necessary.
	Current transformer factor incorrectly programmed.	Read and program the current transformer ratio on the current transformer.
	The peak current value at the measuring input was exceeded by current harmonics.	Install current transformers with a higher current transformer ratio.
	The current at the measuring input is too low.	Install current transformers with a lower current transformer ratio.
Displayed voltage is too low or too high.	Measurement on the wrong phase.	Check connection and correct if necessary.
	Voltage transformer programmed incorrectly.	Read the voltage transformer ratio on the voltage transformer and program.
Displayed voltage is too low.	Overrange.	Use a voltage transformer.
	The voltage peak value at the measuring input was exceeded due to harmonics current.	Attention! Make sure that the measuring inputs are not overloaded.
Phase shift, ind./cap.	Current circuit is assigned to the wrong voltage circuit.	Check connection and correct if necessary.
Active power applied / delivered is interchanged.	At least one current transformer connection is reversed.	Check connection and correct if necessary.
	A current circuit is assigned to the wrong voltage circuit.	Check connection and correct if necessary.
Active power too small or too great.	The programmed current transformer ratio is incorrect.	Read and program the current transformer ratio on the current transformer
	The current circuit is assigned to the wrong voltage circuit.	Check connection and correct if necessary.
	The programmed voltage transformer ratio is incorrect.	Read the voltage transformer ratio on the voltage transformer and program.
An input/output is not responding.	The input/output was programmed incorrectly.	Check programming and correct if necessary.
	The input/output was connected incorrectly.	Check connection and correct if necessary.
Display "Overrange"	The measuring range has been exceeded	Check connection and correct if necessary. Correct the current/voltage transformer ratio.
No connection to the device.	RS-485 - Incorrect device address. - Different bus speeds (baud rate) and / or data frames - Incorrect protocol. - No termination.	- Correct the device address. - Correct the speed (baud rate). - Correct the data frame. - Correct the protocol. - Terminate bus with termination resistor.
Despite the above measures, the device does not function.	Device defective.	Send the device and error description to the manufacturer for inspection.

18. Technical data

General	
Net weight (with attached plug-in connectors)	approx. 250 g (0.55 lbs)
Package weight (incl. accessories)	approx. 500 g (1.1 lbs)
Battery	Type Lithium CR2032, 3 V, (UL 1642 approved)
Data memory	64 MB
Backlight service life	40000 h (backlight reduces to approx. 50% over this period)
Impact resistance	IK07 according to IEC 62262

Transport and storage	
The following information applies to devices that are transported or stored in their original packaging.	
Free fall	1 m (39.37 in)
Temperature	-25 °C (-13 °F) to +70 °C (158 °F)
Relative air humidity (non-condensing)	0 to 90% RH

Environmental conditions during operation	
Install the device in a weather-protected and stationary location. Protection class II according to IEC 60536 (VDE 0106, Part 1).	
Rated temperature range	-10 °C (14 °F) ... +55 °C (131 °F)
Relative air humidity (non-condensing)	0 to 75% RH
Operating elevation	0 .. 2000 m (6562 ft) above sea level
Pollution degree	2
Mounting orientation	As desired
Ventilation	No forced ventilation required.
Protection against foreign matter and water - Front - Rear - Front with seal	IP40 according to EN60529 IP20 according to EN60529 IP54 according to EN60529

Supply voltage		
Option 230 V	Nominal range	AC 90 V - 277 V (50/60 Hz) or DC 90 V - 250 V, 300 V CATIII
	Power consumption	max. 4.5 VA / 2 W
Option 24 V	Nominal range	AC 24 V - 90 V (50/60Hz) or DC 24 V - 90 V, 150 V CATIII
	Power consumption	max. 4.5 VA / 2 W
Operating range	+-10% of nominal range	
Internal fuse, not replaceable	Type T1A / 250 V DC / 277 V AC according to IEC 60127	
Recommended overcurrent protective device for the line protection (UL approval)	Option 230 V: 6 - 16 A (Char. B) Option 24 V: 1 - 6 A (Char. B)	

Voltage measurement	
Three-phase 4-conductor systems with rated voltages up to	417 V / 720 V (+-10%) according to IEC 347 V / 600 V (+-10%) according to UL
Three-phase 3-conductor systems with rated voltages up to	600 V (+10%)
Single-phase 2-conductor system with rated voltages up to	480 V (+-10%)
Overvoltage category	600 V CAT III
Rated surge voltage	6 kV
Protection of the voltage measurement	1 - 10 A tripping characteristic B(with IEC/UL approval)
Measuring range L-N	0 ¹⁾ .. 600 V _{rms} (max. overvoltage 800 V _{rms})
Measuring range L-L	0 ¹⁾ .. 1040 V _{rms} (max. overvoltage 1350 V _{rms})
Resolution	0.01 V
Crest factor	2.45 (related to the measuring range)
Impedance	3 M Ω /phase
Power consumption	approx. 0.1 VA
Sampling frequency	13.67 kHz
Sampling frequency (IT variant)	13.98 kHz
Frequency of the fundamental oscillation - Resolution	45 Hz .. 65 Hz 0.01 Hz
Fourier analysis	1st - 65th harmonic

1) The device only determines measured values if a voltage L1-N of greater than 20 V_{eff} (4-conductor measurement) or a voltage L1-L2 of greater than 34 V_{eff} (3-conductor measurement) is applied to voltage measurement input V1.

Current measurement	
Nominal current	5 A
Measuring range	0.005 .. 6 A _{rms}
Crest factor	2 (relative to 6 A _{rms})
Overvoltage category	300 V CAT II
Rated surge voltage	2 kV
Power consumption	approx. 0.2 VA (R _i =5 m Ω)
Overload for 1 s	60 A (sinusoidal)
Resolution	0.1 mA (display 0.01 A)
Sampling frequency	13.67 kHz
Sampling frequency (IT variant)	13.98 kHz
Fourier analysis	1st - 65th harmonic

Serial interface	
RS-485 - Modbus RTU/client device	9.6 kbps, 19.2 kbps, 38.4 kbps, 57.6 kbps, 115.2 kbps

Digital outputs	
3 digital outputs, solid state relays, not short-circuit proof.	
Switching voltage	max. 33 V AC, 40 V DC
Switching current	max. 50 mA _{eff} AC/DC
Response time	approx. 200 ms
Pulse output	max. 50 Hz (energy pulses)

Digital inputs	
3 digital inputs, solid state relays, not short-circuit proof.	
Maximum counter frequency	20 Hz
Input signal applied	18 V .. 28 V DC (typically 4 mA)
Input signal not applied	0 .. 5 V DC, current less than 0.5 mA

Cable length (digital inputs/outputs)	
Up to 30 m (32.81 yd)	Unshielded
Greater than 30 m (32.81 yd)	Shielded

Analog outputs	
External power supply	max. 33 V
Current	0 .. 20 mA
Update time	1 s
Load	max. 300 Ω
Resolution	10 bit

Connecting capacity of the terminals (supply voltage)	
Connectible conductors. Only connect one conductor per terminal point!	
Single core, multi-core, fine-stranded	0.2 - 4.0 mm ² , AWG 28-12
Wire ferrules (non-insulated)	0.2 - 2.5 mm ² , AWG 26-14
Wire ferrules (insulated)	0.2 - 2.5 mm ² , AWG 26-14
Tightening torque	0.4 - 0.5 Nm (3.54 - 4.43 lbf in)
Strip length	7 mm (0.2756 in)

Connecting capacity of the terminals (voltage measurement)	
Connectible conductors. Only connect one conductor per terminal point!	
Single core, multi-core, fine-stranded	0.2 - 4.0 mm ² , AWG 28-12
Wire ferrules (non-insulated)	0.2 - 2.5 mm ² , AWG 26-14
Wire ferrules (insulated)	0.2 - 2.5 mm ² , AWG 26-14
Tightening torque	0.4 - 0.5 Nm (3.54 - 4.43 lbf in)
Strip length	7 mm (0.2756 in)

Connecting capacity of the terminals (current measurement)	
Connectible conductors. Only connect one conductor per terminal point!	
Single core, multi-core, fine-stranded	0.2 - 4 mm ² , AWG 28-12
Wire ferrules (non-insulated)	0.2 - 4 mm ² , AWG 26-12
Wire ferrules (insulated)	0.2 - 2.5 mm ² , AWG 26-14
Tightening torque	0.4 - 0.5 Nm (3.54 - 4.43 lbf in)
Strip length	7 mm (0.2756 in)

Terminal connection capacity (serial interface)	
Connectible conductors. Only connect one conductor per terminal point!	
Single core, multi-core, fine-stranded	0.2 - 1.5 mm ² , AWG 28-16
Wire ferrules (non-insulated)	0.2 - 1.5 mm ² , AWG 26-16
Wire ferrules (insulated)	0.2 - 1.5 mm ² , AWG 26-16
Tightening torque	0.2 - 0.25 Nm (1.77 - 2.21 lbf in)
Strip length	7 mm (0.2756 in)

Connecting capacity of the terminals (digital inputs/outputs, analog output)	
Connectible conductors. Only connect one conductor per terminal point!	
Single core, multi-core, fine-stranded	0.2 - 1.5 mm ² , AWG 28-16
Wire ferrules (non-insulated)	0.2 - 1.5 mm ² , AWG 26-16
Wire ferrules (insulated)	0.2 - 1.5 mm ² , AWG 26-16
Tightening torque	0.2 - 0.25 Nm (1.77 - 2.21 lbf in)
Strip length	7 mm (0.2756 in)

19. Performance characteristics of functions

Function	Symbol	Accuracy class	Measuring range	Display range
Total active power	P	0.5 ⁵⁾ (IEC61557-12)	0 W .. 12.6 kW	0 W .. 999 GW *
Total reactive power	QA, Qv	1 (IEC61557-12)	0 var .. 16.6 kvar	0 var .. 999 Gvar *
Total apparent power	SA, Sv	0.5 ⁵⁾ (IEC61557-12)	0 VA .. 12.6 kVA	0 VA .. 999 GVA *
Total active energy	Ea	0.2 ⁵⁾ (IEC61557-12) 0.2S ⁵⁾ (IEC62053-22)	0 Wh .. 999 GWh	0 Wh .. 999 GWh *
Total reactive energy	ErA, ErV	1 (IEC61557-12)	0 varh .. 999 Gvarh	0 varh .. 999 Gvarh *
Total apparent energy	EapA, EapV	0.5 ⁵⁾ (IEC61557-12)	0 VAh .. 999 GVAh	0 VAh .. 999 GVAh *
Frequency	f	0.05 (IEC61557-12)	45 Hz .. 65 Hz	45.00 Hz .. 65.00 Hz
Phase current	I	0.2 (IEC61557-12)	0 Arms .. 7 Arms	0 A .. 999 kA
Neutral conductor current calculated	INc	1.0 (IEC61557-12)	0.03 A .. 25 A	0.03 A .. 999 kA
Voltage	U L-N	0.2 (IEC61557-12)	10 Vrms .. 600 Vrms	0 V .. 999 kV
Voltage	U L-L	0.2 (IEC61557-12)	18 Vrms .. 1040 Vrms	0 V .. 999 kV
Power factor	PFA, PFV	0.5 (IEC61557-12)	0.00 .. 1.00	0.00 .. 1.00
Short-term flicker, long-term flicker	Pst, Plt	-	-	-
Voltage dips (L-N)	Udip	-	-	-
Voltage swells (L-N)	Uswl	-	-	-
Transient overvoltages	Utr	-	-	-
Voltage interruptions	Uint	-	-	-
Voltage imbalance (L-N) ¹⁾	Unba	-	-	-
Voltage imbalance (L-N) ²⁾	Unb	-	-	-
Voltage harmonics	Uh	Cl. 1 (IEC61000-4-7)	1 .. 65	0 V .. 999 kV
THD of voltage ³⁾	THDu	1.0 (IEC61557-12)	0% .. 999%	0% .. 999%
THD of voltage ⁴⁾	THD-Ru	-	-	-
Current harmonics	Ih	Cl. 1 (IEC61000-4-7)	1 .. 65	0 A .. 999 kA
THD of current ³⁾	THDi	1.0 (IEC61557-12)	0% .. 999%	0% .. 999%
THD of current ⁴⁾	THD-Ri	-	-	-
Mains signal voltage	MSV	-	-	-

1) Referenced to the amplitude.

2) Referenced to the phase and amplitude.

3) Referenced to the fundamental oscillation.

4) Referenced to the effective value.

5) Accuracy class 0.2/0.2S with ../5A transformer.

Accuracy class 0.5/0.5S with ../1A transformer.

*When the maximum total energy values are reached, the display returns to 0 W.

19.1 Modbus addresses of frequently used measured values

Address	Format	RD/WR	Variable	Unit	Comment
19000	float	RD	_ULN[0]	V	Voltage L1-N
19002	float	RD	_ULN[1]	V	Voltage L2-N
19004	float	RD	_ULN[2]	V	Voltage L3-N
19006	float	RD	_ULL[0]	V	Voltage L1-L2
19008	float	RD	_ULL[1]	V	Voltage L2-L3
19010	float	RD	_ULL[2]	V	Voltage L3-L1
19012	float	RD	_ILN[0]	A	Apparent current, L1
19014	float	RD	_ILN[1]	A	Apparent current, L2
19016	float	RD	_ILN[2]	A	Apparent current, L3
19018	float	RD	_I_SUM3	A	Sum; $I_N=I_1+I_2+I_3$
19020	float	RD	_PLN[0]	W	Active power L1
19022	float	RD	_PLN[1]	W	Active power L2
19024	float	RD	_PLN[2]	W	Active power L3
19026	float	RD	_P_SUM3	W	Sum; $P_{sum3}=P_1+P_2+P_3$
19028	float	RD	_SLN[0]	VA	Apparent power L1
19030	float	RD	_SLN[1]	VA	Apparent power L2
19032	float	RD	_SLN[2]	VA	Apparent power L3
19034	float	RD	_S_SUM3	VA	Sum; $S_{sum3}=S_1+S_2+S_3$
19036	float	RD	_QLN[0]	var	Reactive power (mains frequency) L1
19038	float	RD	_QLN[1]	var	Reactive power (mains frequency) L2
19040	float	RD	_QLN[2]	var	Reactive power (mains frequency) L3
19042	float	RD	_Q_SUM3	var	Sum; $Q_{sum3}=Q_1+Q_2+Q_3$
19044	float	RD	_COS_PHI[0]		Fund. power factor, CosPhi; UL1 IL1
19046	float	RD	_COS_PHI[1]		Fund. power factor, CosPhi; UL2 IL2
19048	float	RD	_COS_PHI[2]		Fund. power factor, CosPhi; UL3 IL3
19050	float	RD	_FREQ	Hz	Frequency
19052	float	RD	_PHASE_SEQ		Rotating field; 1=right, 0=none, -1=left
19054*	float	RD	_WH_V[0]	Wh	Active energy L1, applied
19056*	float	RD	_WH_V[1]	Wh	Active energy L2, applied
19058*	float	RD	_WH_V[2]	Wh	Active energy L3, referred
19060	float	RD	_WH_V_HT_SUML13	Wh	Active energy L1..L3
19062	float	RD	_WH_V[0]	Wh	Active energy L1, applied
19064	float	RD	_WH_V[1]	Wh	Active energy L2, applied
19066	float	RD	_WH_V[2]	Wh	Active energy L3, referred
19068	float	RD	_WH_V_HT_SUML13	Wh	Active energy L1..L3, applied, tariff 1
19070	float	RD	_WH_Z[0]	Wh	Active energy L1, delivered
19072	float	RD	_WH_Z[1]	Wh	Active energy L2, delivered
19074	float	RD	_WH_Z[2]	Wh	Active energy L3, delivered
19076	float	RD	_WH_Z_SUML13	Wh	Active energy L1..L3, delivered
19078	float	RD	_WH_S[0]	VAh	Apparent energy L1
19080	float	RD	_WH_S[1]	VAh	Apparent energy L2
19082	float	RD	_WH_S[2]	VAh	Apparent energy L3
19084	float	RD	_WH_S_SUML13	VAh	Apparent energy L1..L3
19086*	float	RD	_IQH[0]	varh	Reactive energy, inductive, L1
19088*	float	RD	_IQH[1]	varh	Reactive energy, inductive, L2
19090*	float	RD	_IQH[2]	varh	Reactive energy, inductive, L3
19092	float	RD	_IQH_SUML13	varh	Reactive energy L1..L3
19094	float	RD	_IQH[0]	varh	Reactive energy, inductive, L1

* The assignment of the marked device addresses does not correspond to the assignment of other devices of the UMG series.

Address	Format	RD/WR	Variable	Unit	Comment
19096	float	RD	_IQH[1]	varh	Reactive energy, inductive, L2
19098	float	RD	_IQH[2]	varh	Reactive energy, inductive, L3
19100	float	RD	_IQH_SUML13	varh	Reactive energy L1..L3, ind.
19102	float	RD	_CQH[0]	varh	Reactive energy, capacitive, L1
19104	float	RD	_CQH[1]	varh	Reactive energy, capacitive, L2
19106	float	RD	_CQH[2]	varh	Reactive energy, capacitive, L3
19108	float	RD	_CQH_SUML13	varh	Reactive energy L1..L3, cap.
19110	float	RD	_THD_ULN[0]	%	Harmonics, THD,U L1-N
19112	float	RD	_THD_ULN[1]	%	Harmonics, THD,U L2-N
19114	float	RD	_THD_ULN[2]	%	Harmonics, THD,U L3-N
19116	float	RD	_THD_ILN[0]	%	Harmonics, THD,I L1
19118	float	RD	_THD_ILN[1]	%	Harmonics, THD,I L2
19120	float	RD	_THD_ILN[2]	%	Harmonics, THD,I L3

19.2 Number formats

Type	Size	Minimum	Maximum
short	16 bit	-2^{15}	$2^{15} - 1$
ushort	16 bit	0	$2^{16} - 1$
int	32 bit	-2^{31}	$2^{31} - 1$
uint	32 bit	0	$2^{32} - 1$
float	32 bit	IEEE 754	IEEE 754

19.3 Note on saving measured values and configuration data

INFORMATION

Saving measured values and configuration data!

In the event of an **operating voltage failure** the recording can be interrupted for a maximum of 5 minutes. The following **measured values are saved by the device every 5 minutes** in a non-volatile memory:

- Comparator timer
- S0 meter readings
- Minimum, maximum and average values (without date and time)
- Energy values

The device saves configuration data immediately!

19.4 Dimensional drawings

· The figures are for illustration purposes only and are not to scale.

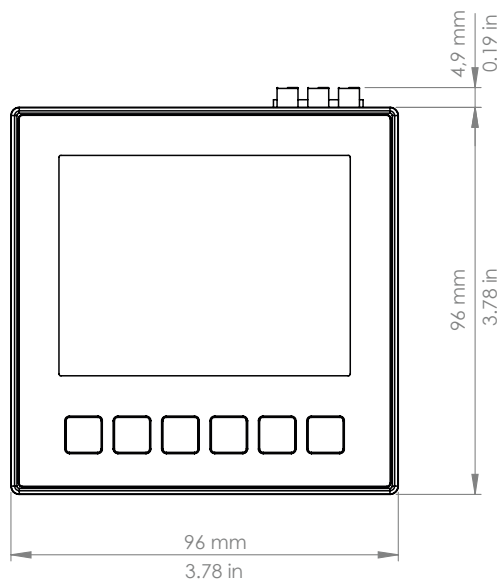
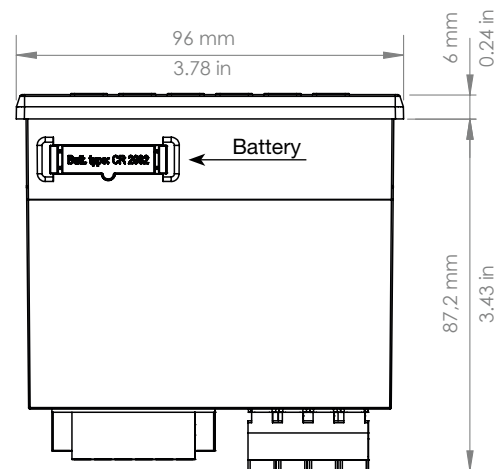

Fig. Front view



1) Bottom view

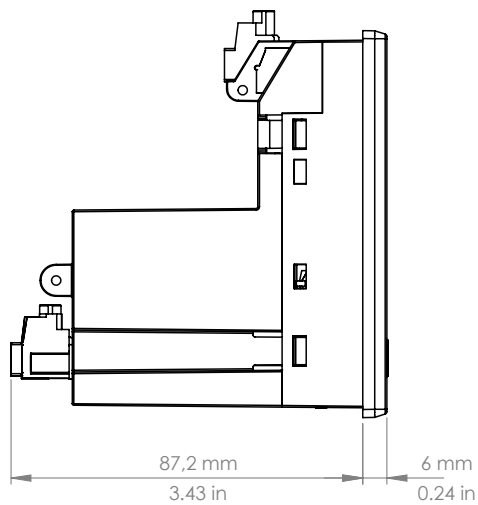

Fig. Side view

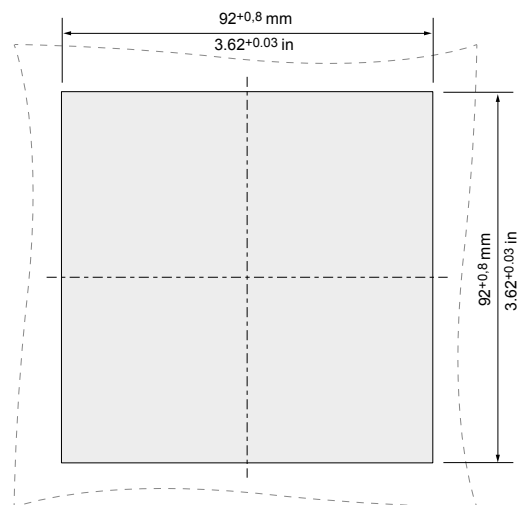
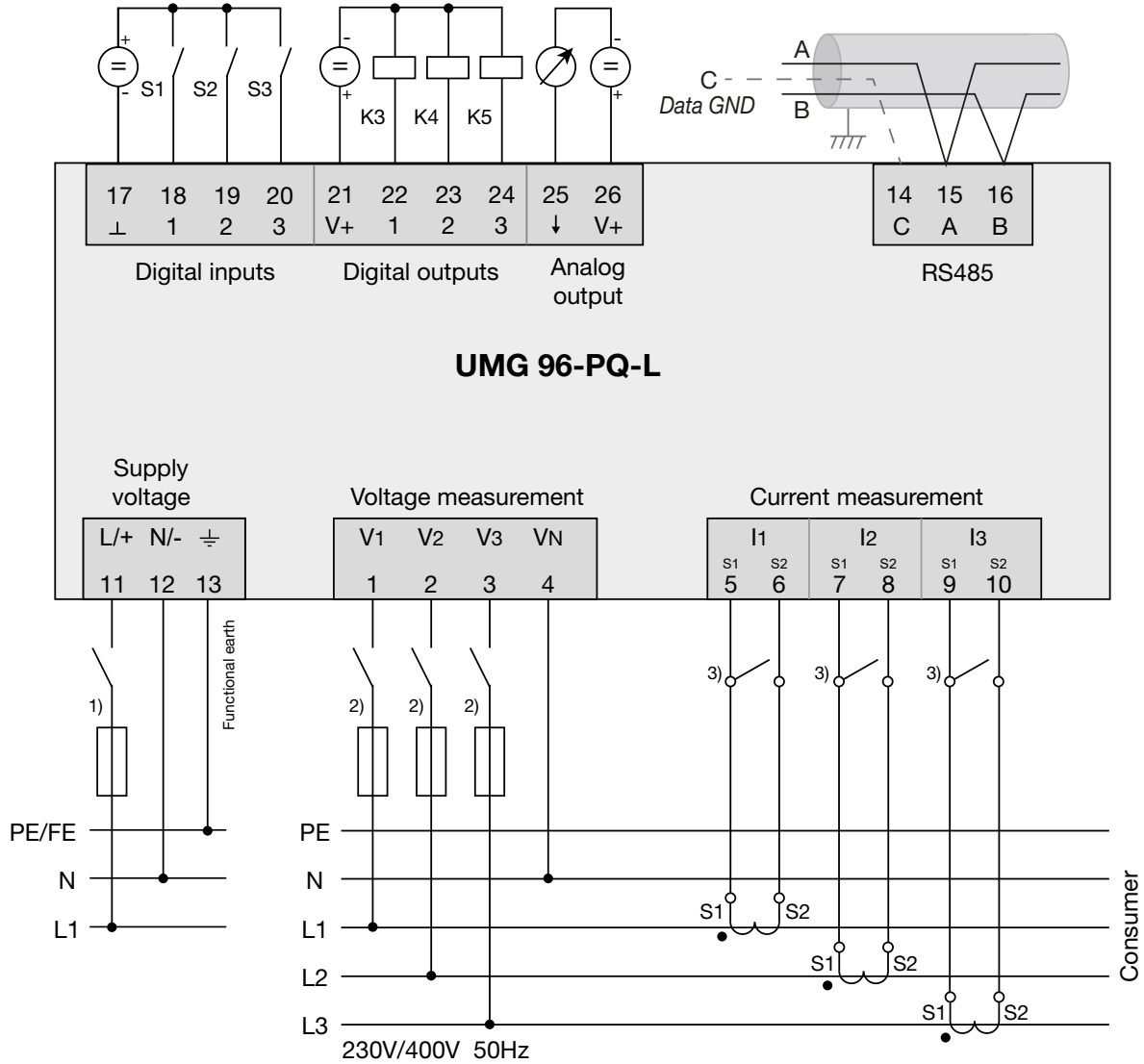

Fig. Cutout dimensions

19.5 Connection example 1



- 1) UL/IEC approved overcurrent protective device
- 2) UL/IEC approved overcurrent protective device
- 3) Short circuit bridges (external)

Janitza[®]

Janitza electronics GmbH
Vor dem Polstück 6
D-35633 Lahnau

Tel.: +49 6441 - 9642-0
Fax: +49 6441 - 9642-30
Email: info@janitza.de
www.janitza.de