

Field-wireable, M12, male, straight, 4 poles, insulation displacement contact, 32V 4A

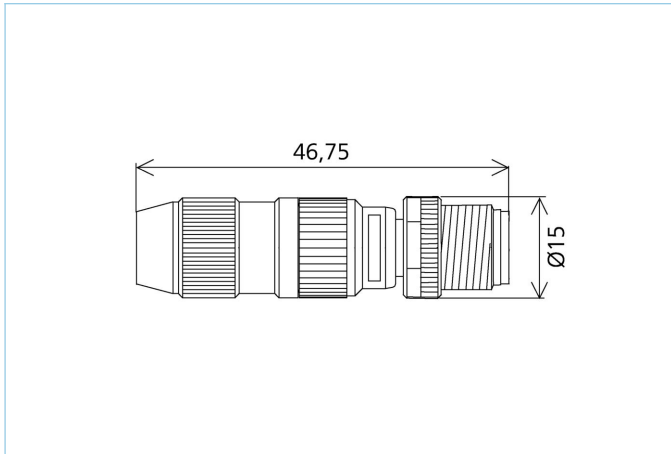

Product data	
Item description	WASC4S
Item-No.	8019716
Customs tariff-No.	85366990
Step-File	WASC4S.stp
EAN	4047106055981
Technical data	
Connector	male, straight, M12
Number of pins	4
Coding	A
Rated voltage	32V
Current load per pin (at 40°C)	4A
Insulation resistance	≥10 ⁹ Ω
Resistance	≤ 10mΩ
Ambient temperature product	-40°C...+85°C
Contact material	Metal, brass, gold-plated
Contact-carrier material	Plastic, PA, BK
Grip body material	Plastic, PA, BK
Connecting cross-section	0.14...0.34 mm ² AWG26...22
Cable outlet	2,9...5,1 mm
Connecting type	Insulation displacement contact
Standards	IEC 61076-2-101
Degree of protection (mounted)	IP67
Mechanical life-cycle	>100 mating cycles
Degree of pollution	3
Style	straight

Manual

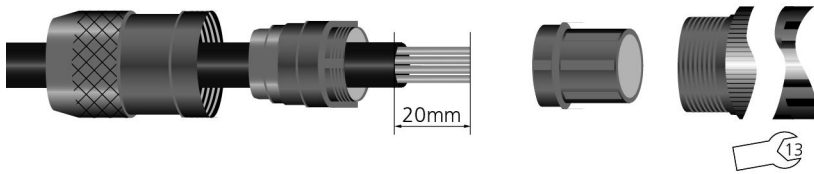

Classification

eCl@ss 6.0	27260702
eCl@ss 7.0	27440102
eCl@ss 8.0	27440102
eCl@ss 9.0	27440102
ETIM 5.0	EC002635
ETIM 6.0	EC002635

Link to product

<https://www.escha.net/en/products/standard/field-wireable-connectors/8019716>