

M8, female, angled, 4 poles, M8, male, angled, 4 poles, sensor-/actuator cable, high-temperature

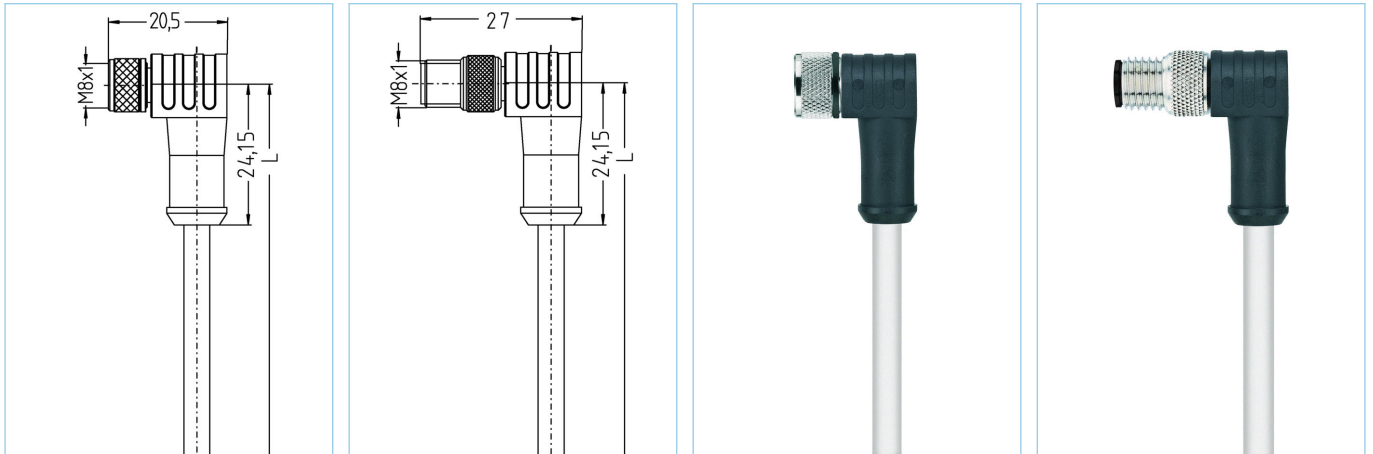

Product data

Item description	HT-SWKP4-2-HT-SWSP4/S2430
Item-No.	8039981
Length	2m
Customs tariff-No.	85444290
Step-File	HT-SWKP4-HT-SWSP4_S2430.stp
EAN	4047106002053

Technical data

	A-side	B-side
Connector	female, angled, M8	male, angled, M8
Number of pins	4	4
Pin assignment	1 BN, 2 WH, 3 BU, 4 BK	30V
Rated voltage	60V	60V
Current load (at 40°C)	4A	4A
Insulation resistance	≥10 ⁹ Ω	≥10 ⁹ Ω
Ambient temperature product	-20°C...+150°C	-20°C...+150°C
Contact material	Metal, CuZn, gold-plated	Metal, CuZn, gold-plated
Contact-carrier material	Plastic, PBT GF, BK	Plastic, PBT GF, BK
Grip body material	Plastic, PBT GF, BK	Plastic, PBT GF, BK
Coupling nut material	Metal, CuZn, nickel-plated	Metal, CuZn, nickel-plated
Sealing (female) material	FPM/FKM	
Standards	IEC 61076-2-104	IEC 61076-2-104
Degree of protection (mounted)	IP65	IP65
Mechanical life-cycle	>100 mating cycles	>100 mating cycles
Degree of pollution	3/2	3/2

Cable	PTFE, S2430, high temp
--------------	-------------------------------

The thermal resistance of this high-temperature cable extends from -190°C to +260°C. Due to its fully fluorinated jacket and wire insulation, the cable is perfectly suited for applications in high-frequency cables, as control cable in critical temperature areas, and in the computer-, and aviation industry. In addition, it stands out through a very good chemical strength, as well as its ozone- and weather resistance.

Outer diameter of jacket	3.80 mm
Cable-jacket material	PTFE
Jacket color	WH, similar RAL9003
Wire cross-section	5 x AWG22
Wire insulation material	PTFE
Wire colors	BN, WH, BU, BK, GY
Wire structure	7 x 0.254 mm
Bending radius (fixed)	5 x Ø-cable
Bending radius (repeated)	10 x Ø-cable
Temperature range (fixed)	-190°C...+260°C
Rated voltage cable	≤250 V
Special features	seawater resistant, LABS free, RoHs compliant, ozone resistant, UV resistant, hydrolysis proof, flexibility at low temperature, non-flammable, low emission of smoke, excellent chemicals resistance, flexible at high temperatures

Classification	
-----------------------	--

eCl@ss 6.0	27279218
eCl@ss 7.0	27279218
eCl@ss 8.0	27279218
eCl@ss 9.0	27060311
ETIM 5.0	EC001855
ETIM 6.0	EC001855

Accessories

Mounting-set, M8
<https://www.escha.net/en/products/standard/accessories-for-connectivity/8047663>

Torque-wrench set
<https://www.escha.net/en/products/standard/accessories-for-connectivity/8055431>

Marking rings Ø 9mm
<https://www.escha.net/en/products/standard/accessories-for-connectivity?p=1&o=3&n=15&f=809>

Link to product

<https://www.escha.net/en/products/standard/sensoractuator-connectors/8039981>