

Valve connector, housing style A, 2+PE bridged, M12, male, straight, 5 poles, suppressor diode, sensor-/actuator cable

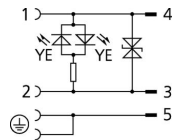
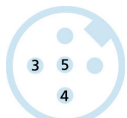
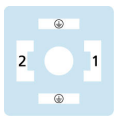
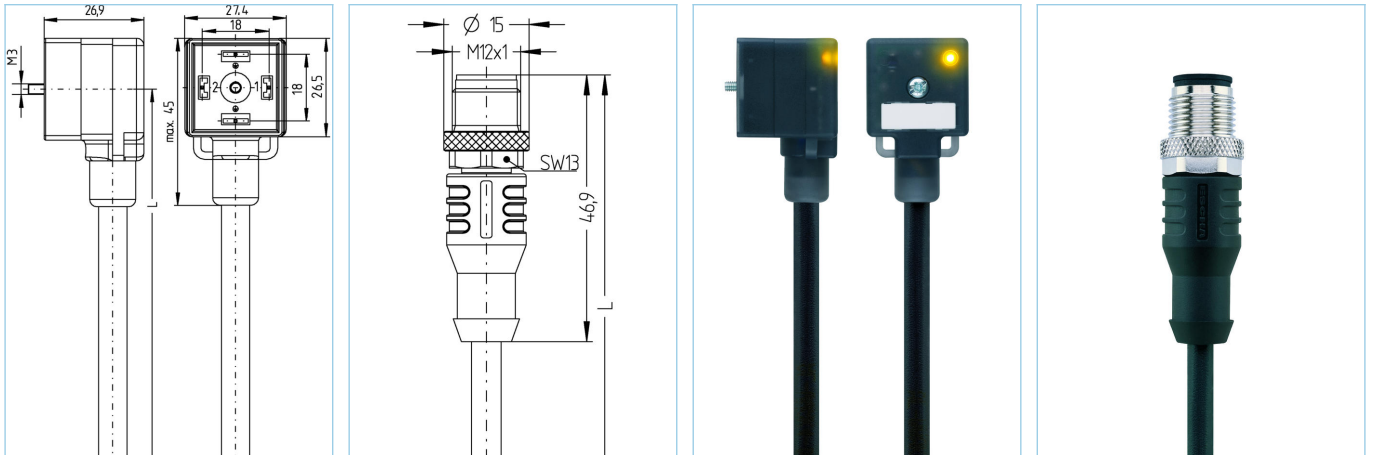

Product data

Item description	VA22-24.3-5-AL-WAS5.002/S370
Item-No.	8050783
Length	5m
Customs tariff-No.	85444290
Step-File	VA22-24.3-L-AL-WAS5..stp
EAN	4047106010928
Label-carrier	2 pieces

Technical data	A-side	B-side
Connector	female, angled, Valve A	male, straight, M12
Number of pins	2+PE, PE bridged	2+PE
Pin assignment	1 BN, 2 BU, PE: GNYE	3 BU, 4 BN, 5 GNYE
Coding of		A
Rated voltage	30V _{AC/DC}	60V
Current load (at 40°C)	4A	4A
Insulation resistance	≥10 ⁹ Ω	≥10 ⁹ Ω
Ambient temperature product	-30°C...+90°C	-30°C...+90°C
Contact material	Metal, CuSn, silver-plated	Metal, CuZn, gold-plated
Contact-carrier material	Plastic, PA, BK	Plastic, TPU, BK
Grip body material	Plastic, TPU, BK, translucent	Plastic, TPU, BK
Coupling nut material		Metal, CuZn, nickel-plated
Sealing (female) material	Plastic, TPU	
Signal status-indicator	LED YE	
Protection circuit	Suppressor diode	
Fixing screw	Metal, CuZn, nickel-plated	
Housing style	A	
Standards	DIN EN 175301-803	IEC 61076-2-101
Degree of protection (mounted)	IP65, IP67, IP68	IP65, IP67, IP68
Mechanical life-cycle	>100 mating cycles	>100 mating cycles
Degree of pollution	3	3

Cable	PUR, UL, S370
--------------	----------------------

Flexible, silicone- and halogen-free control line with high mechanical strength. The cable is chemicals, hydrolysis-, and microbes- resistant. The drag-chain application is possible at a bending radius of minimum 10 x d. Due to its weld-field immunity, the cable is very well suited for the flexible application in robotics, machine-tool, and metal-cutting production. The cables meet the UL and CSA (UL10493/20549; cULus) requirements.

Outer diameter of jacket	5.20 mm
Cable-jacket material	PUR
Jacket color	BK, similar RAL9005
Wire cross-section	5 x 0.34 mm ²
Wire insulation material	PP
Wire colors	BN, WH, BU, BK, GNYE
Wire structure	42 x 0.10 mm
Bending radius (fixed)	5 x Ø-cable
Bending radius (repeated)	10 x Ø-cable
Temperature range (repeated)	-30°C...+90°C
Temperature range (fixed)	-40°C...+90°C
Temperature range (drag chain)	-25°C...+60°C
Drag chain-application	3 Mio. cycles
Halogen-free	Yes
Torsion	+/-180°/m, < 1 Mio. cycles
Rated voltage cable	≤300 V
Special features	flame retardant, seawater resistant, recyclable, LABS free, RoHs compliant, acid- and alkali resistant, ozone resistant, UV resistant, hydrolysis proof, drag chain-adapted, torsion resistant, welding sparks resistant, halogen free, silicone free, oil resistant

Classification	
-----------------------	--

eCl@ss 6.0	27279218
eCl@ss 7.0	27279218
eCl@ss 8.0	27279218
eCl@ss 9.0	27060312
ETIM 5.0	EC001855
ETIM 6.0	EC001855

Accessories

Labels, Valve connector
<https://www.escha.net/en/products/standard/accessories-for-connectivity/8047109>

Link to product

<https://www.escha.net/en/products/standard/valve-connectors/8050783>