

M8, female, angled, 5 poles, M8, male, straight, 5 poles, sensor-/actuator cable

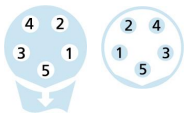
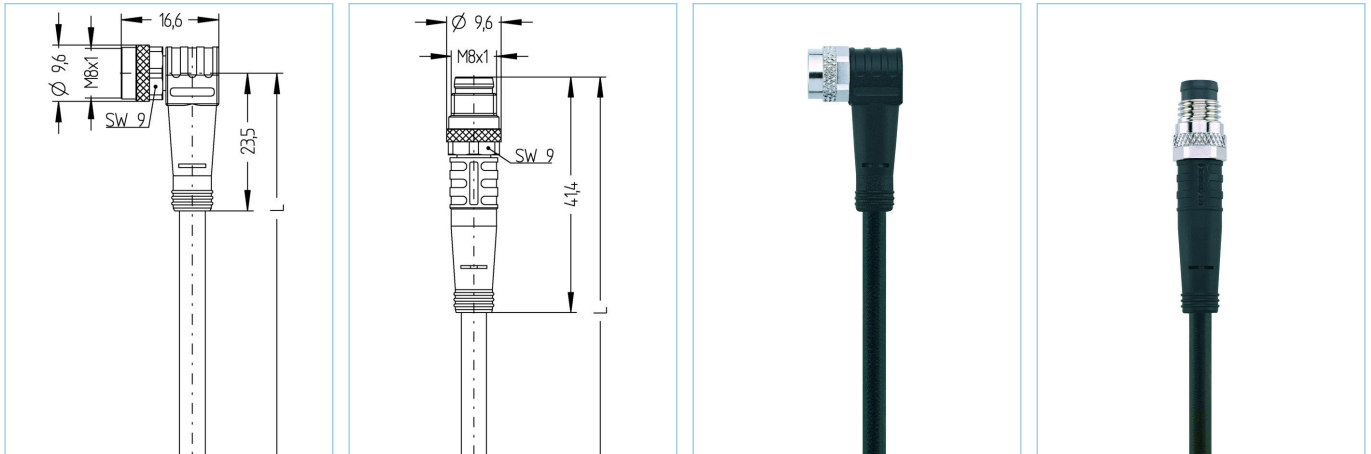

Product data

Item description	AL-SWKP4.5-5-AL-SSP4.5/S370
Item-No.	8052763
Length	5m
Customs tariff-No.	85444290
Step-File	AL-SWKP4_5_AL-SSP4_5.stp
EAN	4047106138547
Label-carrier	2 pieces

Technical data	A-side	B-side
Connector	female, angled, M8	male, straight, M8
Number of pins	5	5
Pin assignment	1 BN, 2 WH, 3 BU, 4 BK, 5 GY	1 BN, 2 WH, 3 BU, 4 BK, 5 GY
Rated voltage	30V	30V
Current load (at 40°C)	3A	3A
Insulation resistance	$\geq 10^8 \Omega$	$\geq 10^8 \Omega$
Resistance	$\leq 5 m\Omega$	$\leq 5 m\Omega$
Ambient temperature product	-30°C...+90°C	-30°C...+90°C
Contact material	Metal, CuZn, gold-plated	Metal, CuZn, gold-plated
Contact-carrier material	Plastic, TPU, BK	Plastic, TPU, BK
Grip body material	Plastic, TPU, BK	Plastic, TPU, BK
Coupling nut material	Metal, CuZn, nickel-plated	Metal, CuZn, nickel-plated
Sealing (female) material	FPM/FKM	
Standards	IEC 61076-2-104	IEC 61076-2-104
Degree of protection (mounted)	IP65, IP67, IP68	IP65, IP67, IP68
Mechanical life-cycle	>100 mating cycles	>100 mating cycles
Degree of pollution	3	3

Cable	PUR, UL, S370
--------------	----------------------

Flexible, silicone- and halogen-free control line with high mechanical strength. The cable is chemicals, hydrolysis-, and microbes- resistant. The drag-chain application is possible at a bending radius of minimum 10 x d. Due to its weld-field immunity, the cable is very well suited for the flexible application in robotics, machine-tool, and metal-cutting production. The cables meet the UL and CSA (UL10493/20549; cULus) requirements.

Outer diameter of jacket	4.70 mm
Cable-jacket material	PUR
Jacket color	BK, similar RAL9005
Wire cross-section	5 x 0.25 mm ²
Wire insulation material	PP
Wire colors	BN, WH, BU, BK, GY
Wire structure	32 x 0.10 mm
Bending radius (fixed)	5 x Ø-cable
Bending radius (repeated)	10 x Ø-cable
Temperature range (repeated)	-30°C...+90°C
Temperature range (fixed)	-40°C...+90°C
Temperature range (drag chain)	-25°C...+60°C
Drag chain-application	3 Mio. cycles
Halogen-free	Yes
Torsion	+/-180°/m, < 1 Mio. cycles
Rated voltage cable	≤300 V
Special features	flame retardant, seawater resistant, recyclable, LABS free, RoHs compliant, acid- and alkali resistant, ozone resistant, UV resistant, hydrolysis proof, drag chain-adapted, torsion resistant, welding sparks resistant, halogen free, silicone free, oil resistant

Classification	
-----------------------	--

eCl@ss 6.0	27279218
eCl@ss 7.0	27279218
eCl@ss 8.0	27279218
eCl@ss 9.0	27060311
ETIM 5.0	EC001855
ETIM 6.0	EC001855

Accessories

Mounting-set, M8
<https://www.escha.net/en/products/standard/accessories-for-connectivity/8047663>

Torque-wrench set
<https://www.escha.net/en/products/standard/accessories-for-connectivity/8055431>

Marking rings Ø 9mm
<https://www.escha.net/en/products/standard/accessories-for-connectivity/?p=1&o=3&n=15&f=809>

Link to product

<https://www.escha.net/en/products/standard/sensoractuator-connectors/8052763>