

M8, female, angled, 4 poles, with LED, Food & Beverage

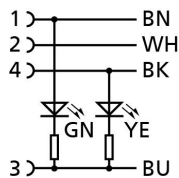
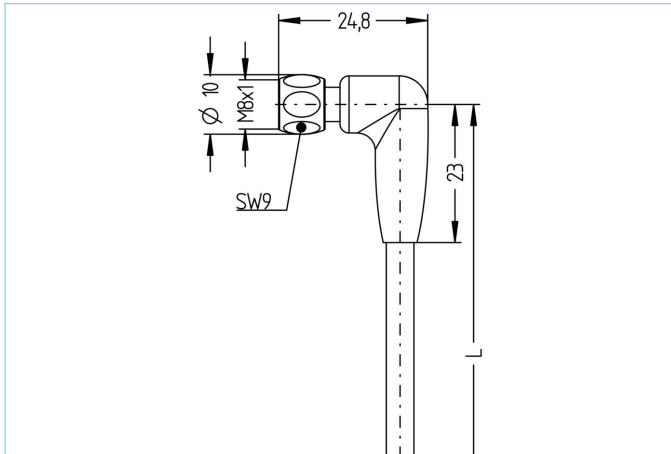

Product data

Item description	FB-SWKPH4P2-10/P00
Item-No.	8063753
Length	10m
Customs tariff-No.	85444290
Step-File	FB-SWKPH4P2.stp
EAN	4047106150648

Technical data

Connector	female, angled, M8, with LED
Number of pins	4
Pin assignment	1 BN, 2 WH, 3 BU, 4 BK
Rated voltage	30V
Current load per pin (at 40°C)	4A
Insulation resistance	≥10 ⁹ Ω
Ambient temperature product	-40°C...+105°C
Circuit logic	pnp
Signal status-indicator	LED YE
Operating voltage-indicator	LED GN
Contact material	Metal, CuZn, gold-plated
Contact-carrier material	Plastic, PP, GY
Grip body material	Plastic, PP, GY
Coupling nut material	Stainless steel, V4A
Sealing (female) material	EPDM
Standards	IEC 61076-2-104
Degree of protection (mounted)	IP65, IP67, IP68, IP69
Mechanical life-cycle	>100 mating cycles
Cable end assembly	open cable end
Degree of pollution	3/2
Style	angled

Cable	PVC, P00, GY
--------------	---------------------

PVC-cable for measurement and control-, and sensor technology. Suitable for applications in dry areas on packaging machines, assembly- and conveyor technology. High flexibility with unstressed movement (conditional drag-chain application possible). Predestined for applications in food- and beverage industry.

Outer diameter of jacket	4.20 mm
Cable-jacket material	PVC
Jacket color	GY, similar RAL7040
Wire cross-section	4 x 0.25 mm ²
Wire insulation material	PVC
Wire colors	BN, WH, BU, BK
Wire structure	14 x 0.15 mm
Bending radius (fixed)	5 x Ø-cable
Bending radius (repeated)	10 x Ø-cable
Temperature range (repeated)	0°C...+80°C
Temperature range (fixed)	-25°C...+80°C
Rated voltage cable	≤300 V
Special features	seawater resistant, recyclable, LABS free, RoHs compliant, acid- and alkali resistant, ozone resistant, UV resistant

Classification

eCl@ss 6.0	27279218
eCl@ss 7.0	27279218
eCl@ss 8.0	27279218
eCl@ss 9.0	27060311
ETIM 5.0	EC001855
ETIM 6.0	EC001855

Accessories

Mounting-set, M8 https://www.escha.net/en/products/standard/accessories-for-connectivity/8047663
Torque-wrench set https://www.escha.net/en/products/standard/accessories-for-connectivity/8055431
Marking rings Ø 9mm https://www.escha.net/en/products/standard/accessories-for-connectivity/?p=1&o=3&n=15&f=809
Cable Stripping Tool https://www.escha.net/en/products/standard/accessories-for-connectivity/8066216
Cable Stripping Tool https://www.escha.net/en/products/standard/accessories-for-connectivity/8066215

Link to product

<https://www.escha.net/en/products/standard/connectors-for-the-food-industry/8063753>