

Receptacle Single-ended cordset, M12, female, straight, 4 poles, D-coded, back wall-mounting, shielded, Industrial Ethernet

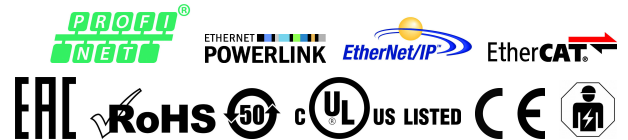
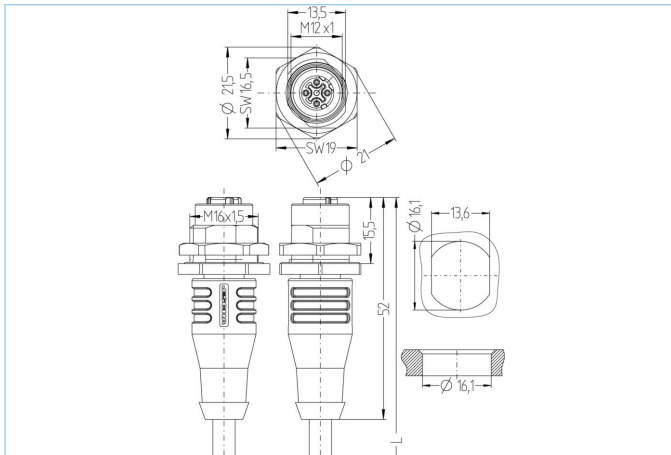

Product data

Item description	IE-FKFDSY4.082-10/16/S3400
Item-No.	8064036
Length	10m
Customs tariff-No.	85444290
Step-File	IE-FKFDSY4_082-m_16.stp
EAN	4047106152772

Technical data

Connector	female, straight, M12
Number of pins	4
Pin assignment	1 WHOG, 2 WHBU, 3 OG, 4BU
Coding	D
Rated voltage	250V
Current load per pin (at 40°C)	4A
Insulation resistance	≥10 ⁹ Ω
Transmission features	Cat5e
Ambient temperature product	-30°C...+90°C
Contact material	Metal, CuZn, gold-plated
Contact-carrier material	Plastic, PA, GN
Grip body material	Plastic, TPU, BK
Receptacle housing material	Metal, CuZn, nickel-plated
Sealing (female) material	FPM/FKM
Material of external sealing	NBR
Shielding	with shielding
Mounting direction	Back wall-mounting (incl. Fixing screw)
Adjustable fixing screw	Yes
Fastening thread	M16x1.5

Connecting type	Cable
Standards	IEC 61076-2-101
Degree of protection (mounted)	IP67
Mechanical life-cycle	>100 mating cycles
Degree of pollution	3
Style	straight

Cable	Cat5e, PUR, UL, S3400
--------------	------------------------------

Shielded PUR Ethernet-cable for industrial applications. Fits to real-time requirements according to IEC61158. The cable meets the UL-Style 21815 (80°/300V)- and the Cat5 (electrical properties according to EN50288-2-2) requirements. Materials and a constructive setup for increased mechanical stresses (abrasion, bending, vibrations etc.) of the cable. Drag-chain/torsion operations are possible. High tensile strength through incorporated Kevlar-strands.

Outer diameter of jacket	4.80 mm
Cable-jacket material	PUR
Jacket color	GN, similar RAL6018
Wire cross-section	1 x 4 x AWG26, star quad
Wire insulation material	PP
Wire colors	WHBU/BU, WHOG/OG
Wire structure	19 x 0.10 mm
Bending radius (fixed)	4 x Ø-cable
Bending radius (repeated)	7,5 x Ø-cable
Temperature range (fixed)	-40°C...+80°C
Transmission features	Cat5
Rated voltage cable	300 V UL rating
Special features	seawater resistant, recyclable, LABS free, RoHs compliant, acid- and alkali resistant, ozone resistant, UV resistant, hydrolysis proof, drag chain-adapted, halogen free, oil resistant, high flexibility, microbes resistant

Classification	
-----------------------	--

eCl@ss 6.0	27279220
eCl@ss 7.0	27440103
eCl@ss 8.0	27440103
eCl@ss 9.0	27440103
ETIM 5.0	EC002061
ETIM 6.0	EC002061

Link to product	
------------------------	--

<https://www.escha.net/en/products/standard/receptacles/8064036>