

DT, male, straight, 2 poles, grip body with thread, Mobile Automation

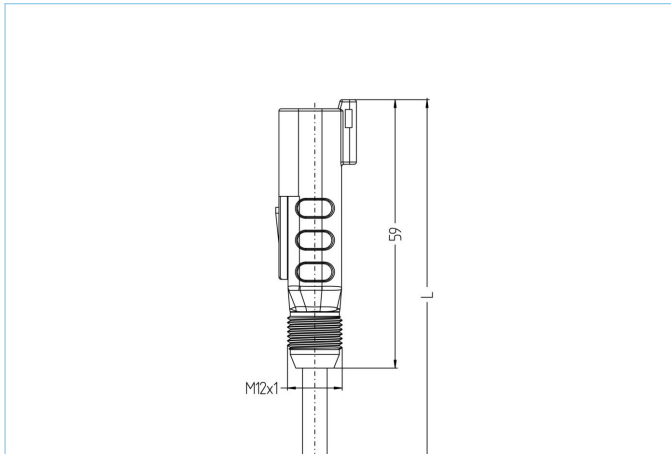

Product data

Item description	MA-DT04-2PG-5/S370
Item-No.	8108789
Length	5m
Customs tariff-No.	85444290
Step-File	MA-DT04-2PG-m.stp
EAN	4047106301538

Technical data

Connector	male, straight, grip body with thread, DT
Number of pins	2
Pin assignment	1 BN, 2 BU
Rated voltage	250V
Current load per pin (at 40°C)	7.5A
Insulation resistance	$\geq 10^9 \Omega$
Ambient temperature product	-40°C...+90°C
Contact material	Metal, CuZn, nickel-plated
Grip body material	Plastic, TPU, BK
Locking	Snap lock
Degree of protection (mounted)	IP67, IP68, IP69
Mechanical life-cycle	>100 mating cycles
Cable end assembly	open cable end
Degree of pollution	3
Style	straight

Cable web	PUR, UL, S370
------------------	----------------------

Flexible, silicone- and halogen-free control line with high mechanical strength. The cable is chemicals, hydrolysis-, and microbes- resistant. The drag-chain application is possible at a bending radius of minimum 10 x d. Due to its weld-field immunity, the cable is very well suited for the flexible application in robotics, machine-tool, and metal-cutting production. The cables meet the UL and CSA (UL10493/20549; cULus) requirements.

Outer diameter of jacket	5.40 mm
Cable-jacket material	PUR
Jacket color	BK, similar RAL9005
Wire cross-section	2 x 0.75 mm ²
Wire insulation material	PP
Wire colors	BN, BU
Wire structure	42 x 0,15 mm
Bending radius (fixed)	5 x Ø-cable
Bending radius (repeated)	10 x Ø-cable
Temperature range (repeated)	-30°C...+90°C
Temperature range (fixed)	-40°C...+90°C
Temperature range (drag chain)	-25°C...+60°C
Drag chain-application	2 Mio. cycles
Halogen-free	Yes
Torsion	+/-180°/m, ≥ 500.000 cycles
Rated voltage cable	≤300 V
Special features	flame retardant, halogen free, hydrolysis proof, LABS free, oil resistant, ozone resistant, recyclable, RoHs compliant, acid- and alkali resistant, drag chain-adapted, welding sparks resistant, seawater resistant, silicone free, torsion resistant, UV resistant

Classification	
-----------------------	--

eCl@ss 6.0	27279200
eCl@ss 7.0	27279218
eCl@ss 8.0	27279218
eCl@ss 9.0	27060311
ETIM 5.0	EC001855
ETIM 6.0	EC001855

Accessories

Marking rings Ø 9mm
<https://www.escha.net/en/products/standard/accessories-for-connectivity?p=1&o=3&n=15&f=809>

Cable Stripping Tool
<https://www.escha.net/en/products/standard/accessories-for-connectivity/8066215>

Link to product

<https://www.escha.net/en/products/standard/deutsch-dt-connectors/8108789>