

M8, female, angled, 8 poles, shielded, sensor-/actuator cable

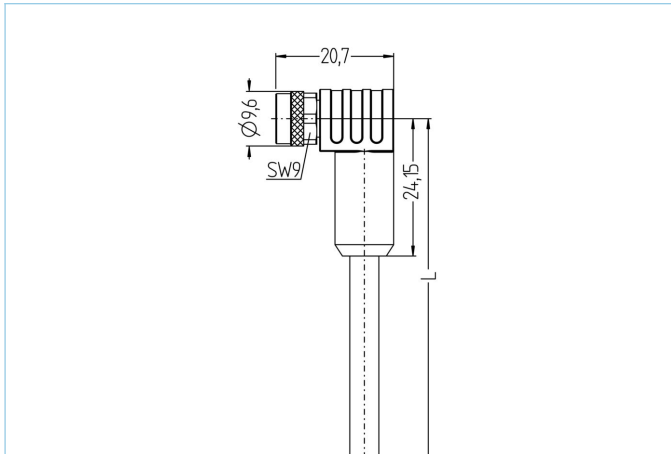

Product data

Item description	AL-SWKPS8-2/P00
Item-No.	8114986
Length	2m
Customs tariff-No.	85444290
Step-File	AL-SWKPS8-m.stp
EAN	4047106317188

Technical data

Connector	female, angled, M8
Number of pins	8
Pin assignment	1 WH, 2 BN, 3 GN, 4 YE, 5 GY, 6 PK, 7 BU, 8 RD
Rated voltage	30V
Current load per pin (at 40°C)	1.5A
Insulation resistance	$\geq 10^9 \Omega$
Resistance	$\leq 5 m\Omega$
Ambient temperature product	-30°C...+90°C
Contact material	Metal, CuZn, gold-plated
Contact-carrier material	Plastic, TPU, BK
Grip body material	Plastic, TPU, BK
Coupling nut material	Metal, CuZn, nickel-plated
Sealing (female) material	FPM/FKM
Shielding	with shielding
Standards	IEC 61076-2-104
Degree of protection (mounted)	IP65, IP67, IP68
Mechanical life-cycle	>100 mating cycles
Cable end assembly	open cable end
Degree of pollution	3
Style	angled

Cable	PVC, P00, GY
--------------	---------------------

PVC-cable for measurement and control-, and sensor technology. Suitable for applications in dry areas on packaging machines, assembly- and conveyor technology. High flexibility with unstressed movement (conditional drag-chain application possible). Predestined for applications in food- and beverage industry. Very good EMC-features with shielded versions.

Outer diameter of jacket	6.70 mm
Cable-jacket material	PVC
Jacket color	GY, similar RAL7040
Wire cross-section	8 x 0.25 mm ²
Wire insulation material	PVC
Wire colors	WH, BN, GN, YE, GY, PK, BU, RD
Wire structure	14 x 0.15 mm
Bending radius (fixed)	5 x Ø-cable
Bending radius (repeated)	10 x Ø-cable
Temperature range (repeated)	0°C...+80°C
Temperature range (fixed)	-25°C...+80°C
Shielding	Yes
Rated voltage cable	≤300 V
Special features	good resistance against oils and chemicals, hydrolysis proof, LABS free, ozone resistant, recyclable, RoHs compliant, acid- and alkali resistant, sea-water resistant, UV resistant

Classification	
-----------------------	--

eCl@ss 6.0	27279218
eCl@ss 7.0	27279218
eCl@ss 8.0	27279218
eCl@ss 9.0	27060311
ETIM 5.0	EC001855
ETIM 6.0	EC001855

Accessories

Mounting-clip, M8 https://www.escha.net/en/products/standard/accessories-for-connectivity/8047658
Torque-wrench set https://www.escha.net/en/products/standard/accessories-for-connectivity/8055431
Screw plug, M8 https://www.escha.net/en/products/standard/accessories-for-connectivity/8081771
Cable Stripping Tool https://www.escha.net/en/products/standard/accessories-for-connectivity/8066215
Cable Stripping Tool https://www.escha.net/en/products/standard/accessories-for-connectivity/8066216

Link to product

<https://www.escha.net/en/products/standard/sensoractuator-connectors/8114986>