

VARIMETER Reverse Power Relay BH 9140, RP 9140

Translation
of the original instructions

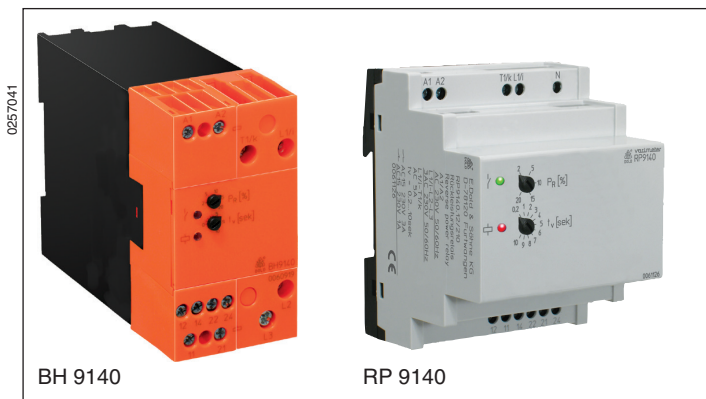

- According to IEC/EN 60255-1
- Effective power measuring
- For single and 3-phases
- Adjustable response value 2 ... 20 % reverse power
- Hysteresis 12.5 %
- Rated current BH 9140: 5 A or 40 A
Rated current RP 9140: 5 A
- Adjustable on delay
- Open circuit operation
- LED indication for voltage supply and contact position
- 2 changeover contacts
- As option closed circuit operation
- Width:
BH 9140: 45 mm
RP 9140: 70 mm

Product Description

The reverse power relay BH 9140 and RP 9140 of the VARIMETER -family monitor the flow direction of the energy in an electrical network. This may be necessary at connection points between public mains an industrial systems. The adjust ment is simply made with a rotary switch. LEDs signal the connected power supply and the status of the output relay.

Approvals and Markings



Function Diagram

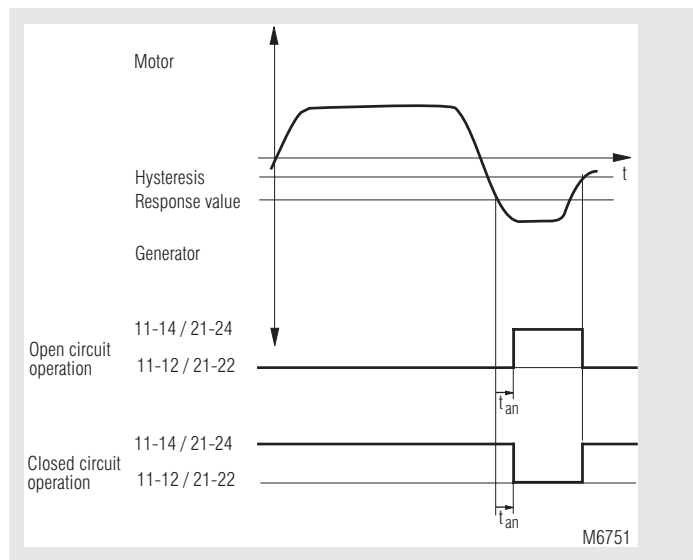

Applications

- Operation of emergency power supply generators
- Generators that change to motor operation

Function

The response value can be adjusted on P_R from 2 ... 20 %. The reverse power is calculated for 3p4w and 3p3w units according to the formula:

$$U_{star} \times I_u \times \cos \varphi \times \text{response value (\%)}$$

At a setting of 20 % and $\cos \varphi = 1$ this is for BH 9140 max.:
 $230 \text{ V} \times 5 \text{ A} \times 0.2 = 230 \text{ W}$
 $230 \text{ V} \times 40 \text{ A} \times 0.2 = 1840 \text{ W}$

And for RP 9140 max. :
 $230 \text{ V} \times 5 \text{ A} \times 0.2 = 230 \text{ W}$

Indicators

LED green: On, when auxiliary supply connected
 LED green/red: On, when corresponding output relay is active

Notes

If the current is higher than the nominal current of the device an external current transformer can be used with min. 2.5 VA. The direction of the current has to be observed.

Circuit Diagrams

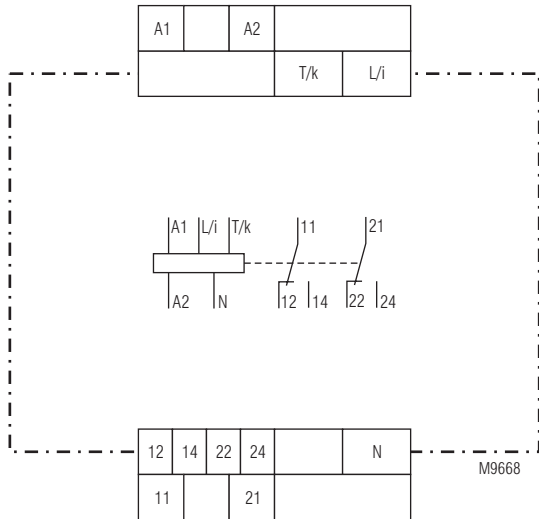

BH 9140: Version for single- and 3-phase connection with N

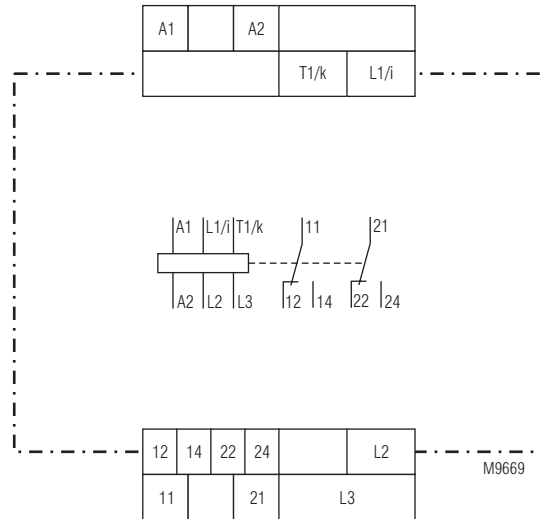

BH 9140: Version for 3-phase connection without N

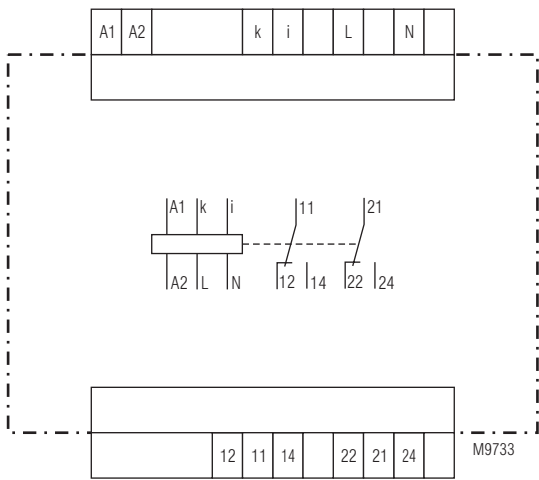

RP 9140: Version for single- and 3-phase connection with N

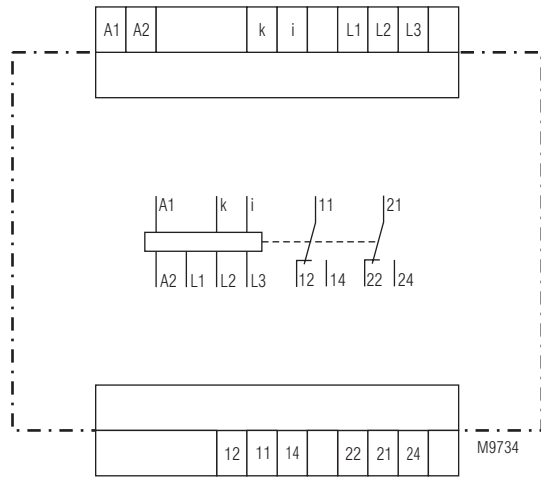

RP 9140: Version for 3-phase connection without N

Connection Terminals

Terminal designation	Signal description
A1 / A2	Auxiliary voltage
i / k	Current path
L1, L2, L3, N	Measuring voltage
11, 12, 14	Changeover contact relay 1
21, 22, 24	Changeover contact relay 2

Technical Data

Measuring Circuit

Voltage

Nominal voltage U_N	
L1-N:	AC 110, 230 V
L1-L2-L3:	3 AC 110, 230, 400, 440 V
Max. overload:	1.1 U_N

Current

Nominal current:	5 A / (40 A only for BH 9140)
Max. overload:	15 A

Power

Response value:	2 ... 20 % reverse power
Hysteresis:	12.5 % of set response value
Frequency range:	45 ... 65 Hz
On delay t_{an} :	Adjustable 0.2 ... 10 s

Auxiliary Circuit

Auxiliary voltage A1, A2:	AC 110, 230, 400, 440 V, DC 24 V*) *) only for BH 9140
----------------------------------	---

Voltage range:	0.8 ... 1.1 U_H
-----------------------	-------------------

Frequency range:	45 ... 65 Hz
-------------------------	--------------

Nominal consumption:	< 4 VA
-----------------------------	--------

Output

Contacts:	2 changeover contacts
------------------	-----------------------

Thermal current I_{th}:	2 x 5 A
---	---------

Switching capacity

According to AC 15

NO contact:	3 A / AC 230 V	IEC/EN 60947-5-1
-------------	----------------	------------------

NC contact:	1 A / AC 230 V	IEC/EN 60947-5-1
-------------	----------------	------------------

According to DC 13:	1 A / DC 24 V	IEC/EN 60947-5-1
---------------------	---------------	------------------

Electrical life		IEC/EN 60947-5-1
------------------------	--	------------------

At 3 A, AC 230 V $\cos \varphi = 1$	2 x 10 ⁵ switching cycles
-------------------------------------	--------------------------------------

Permissible

switching frequency:	1800 switching cycle/H
-----------------------------	------------------------

Short circuit strength

max. fuse rating:	4 A gG / gL	IEC/EN 60947-5-1
--------------------------	-------------	------------------

Mechanical life:	30 x 10 ⁶ switching cycles
-------------------------	---------------------------------------

General Data

Nominal operating mode:	Continuous operation
--------------------------------	----------------------

Temperature range

Operation:	- 20 ... + 60 °C
------------	------------------

Storage:	- 20 ... + 60 °C
----------	------------------

Altitude:	≤ 2000 m
------------------	----------

Clearance and creepage distance

Overvoltage category:	III
-----------------------	-----

Rated impulse voltage / pollution degree:		IEC/EN 60664-1
--	--	----------------

Aux. voltage / measuring voltage:	4 kV / 2
-----------------------------------	----------

Aux. voltage / measuring current:	4 kV / 2
-----------------------------------	----------

Meas. voltage / meas. current:	4 kV / 2 (only for RP 9140)
--------------------------------	-----------------------------

Auxiliary voltage / contacts:	4 kV / 2
-------------------------------	----------

Measuring inputs / contacts:	4 kV / 2
------------------------------	----------

Contacts 11,12,14 / 21,22,24:	4 kV / 2
-------------------------------	----------

Technical Data

EMC

Electrostatic discharge (ESD):	8 kV (air)	IEC/EN 61000-4-2
--------------------------------	------------	------------------

HF irradiation

80 MHz ... 2.7 MHz:	10 V / m	IEC/EN 61000-4-3
---------------------	----------	------------------

Fast transients:	2 kV	IEC/EN 61000-4-4
------------------	------	------------------

Surge

Between

wires for power supply:	1 kV	IEC/EN 61000-4-5
-------------------------	------	------------------

Between wire and ground:	2 kV	IEC/EN 61000-4-5
--------------------------	------	------------------

HF wire guided:	10 V	IEC/EN 61000-4-6
-----------------	------	------------------

Interference suppression

At UH = AC:	Limit value class B	EN 55011
-------------	---------------------	----------

At UH = DC:	Limit value class A*)	
-------------	-----------------------	--

*) The device is designed for the usage under industrial conditions (Class A, EN 55011). When connected to a low voltage public system (Class B, EN 55011) radio interference can be generated. To avoid this, appropriate measures have to be taken.

Degree of protection:

Housing:	IP 40	IEC/EN 60529
----------	-------	--------------

Terminals:	IP 20	IEC/EN 60529
------------	-------	--------------

Housing:

Thermoplastic with V0 behaviour according to UL subject 94

Vibration resistance:

Amplitude 0.35 mm

Frequency 10 ... 55 Hz IEC/EN 60068-2-6

20 / 060 / 04 IEC/EN 60068-1

EN 50005

Climate resistance:

Terminal designation:

Wire connection BH 9140

Load terminals:	1 x 10 mm ² solid or 1 x 6 mm ² stranded wire with sleeve
-----------------	--

11 mm

Max. 1,2 Nm

Box terminals with self-lifting wire protection and Plus-minus terminal screws M4

1 x 4 mm² solid or

2 x 1.5 mm² stranded wire with sleeve or

1 x 2.5 mm² stranded wire with sleeve

DIN 46228-1/-2/-3/-4

10 mm

max. 0.8 Nm

Box terminals with self-lifting wire protection and Plus-minus terminal screws M3.5

Wire connection RP 9140

Fixed screw terminal (S):	0.34 ... 4 mm ² solid or 0.34 ... 1.5 mm ² stranded wire with sleeve
---------------------------	---

7 mm

Max. 0.5 Nm

Captive slotted screw M3

box terminals with wire protection

DIN rail IEC/EN 60715

Mounting:

Weight:

BH 9140:	430 g
----------	-------

RP 9140:	250 g
----------	-------

Dimensions

Width x height x depth:

BH 9140:	45 x 84 x 118 mm
----------	------------------

RP 9140:	70 x 90 x 71 mm
----------	-----------------

Standard Types

BH 9140.12/001 3 AC 400 V 5 A AC 230 V 10 s

Article number: 0060919

- Open circuit operation
- 3-phase connection without neutral
- Response value: 2 ... 20 %
- Nominal voltage U_N : 3 AC 400 V
- Nominal current: 5 A
- Auxiliary voltage U_H : AC 230 V
- On delay: 0.2 ... 10 s
- Width: 45 mm

RP 9140.12/201 3 AC 400 V 5 A AC 230 V 10 s

Article number: 0061258

- Open circuit operation
- 3-phase connection without neutral
- Response value: 2 ... 20 %
- Nominal voltage U_N : 3 AC 400 V
- Nominal current: 5 A
- Auxiliary voltage U_H : AC 230 V
- On delay: 0.2 ... 10 s
- Width: 70 mm

Variants

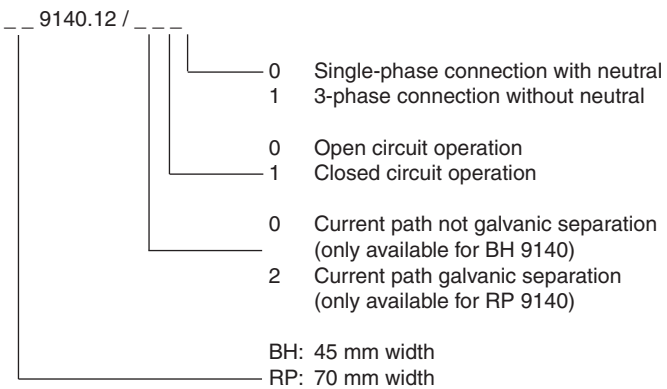

Ordering example for variants

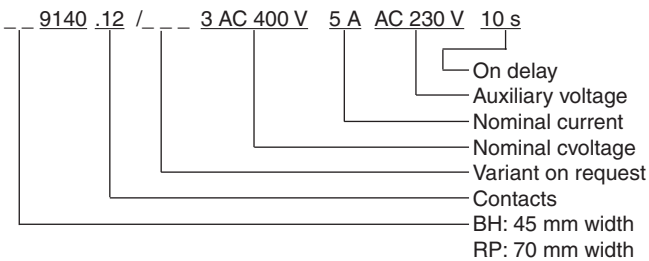

Setting Facilities

Response value

Reverse power: 2 ... 20 %

On delay: 0.2 ... 10 s

Connection Examples BH 9140

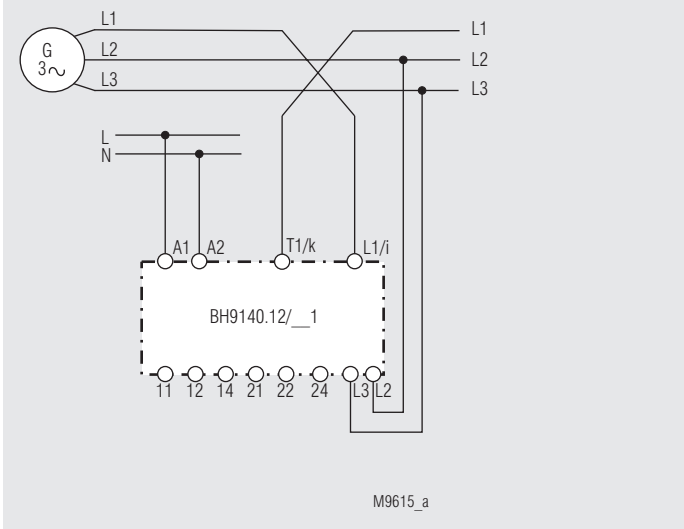

For 3-phase connection without N

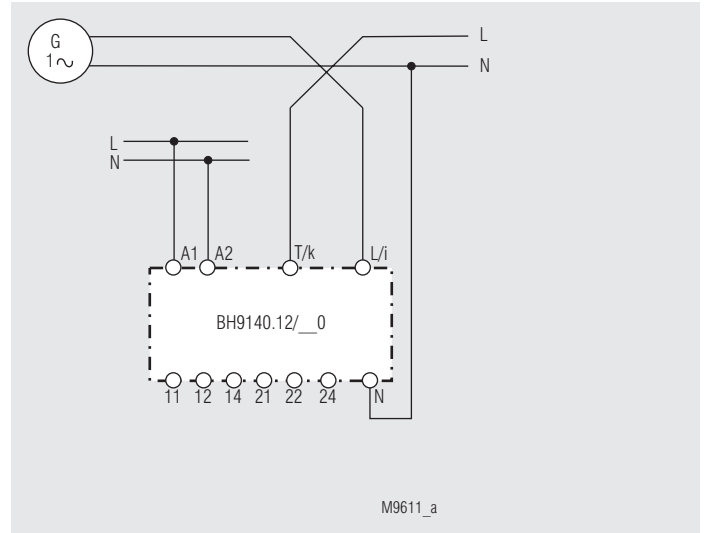

For single or 3-phase connection with N

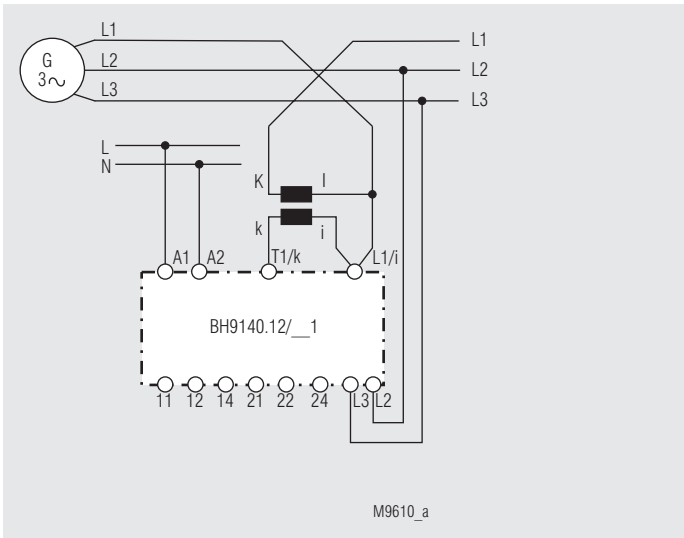

For 3-phase connections with current transformer (external).

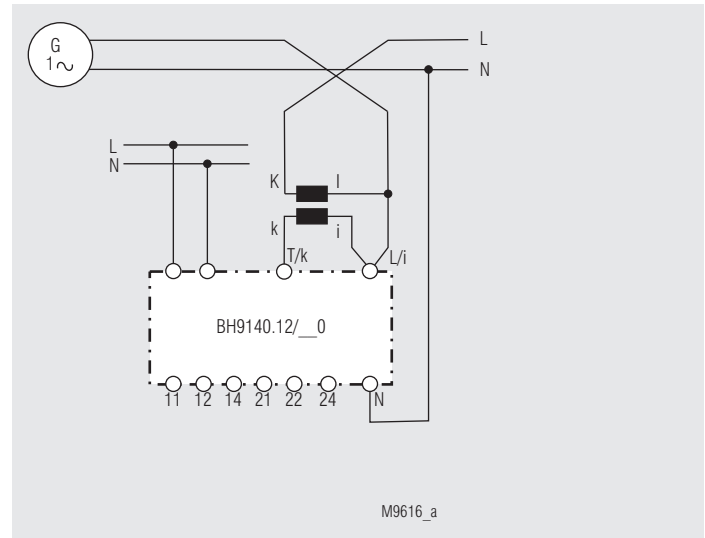

For single or 3-phase connections with current transformer (external)

Connection Examples RP 9140

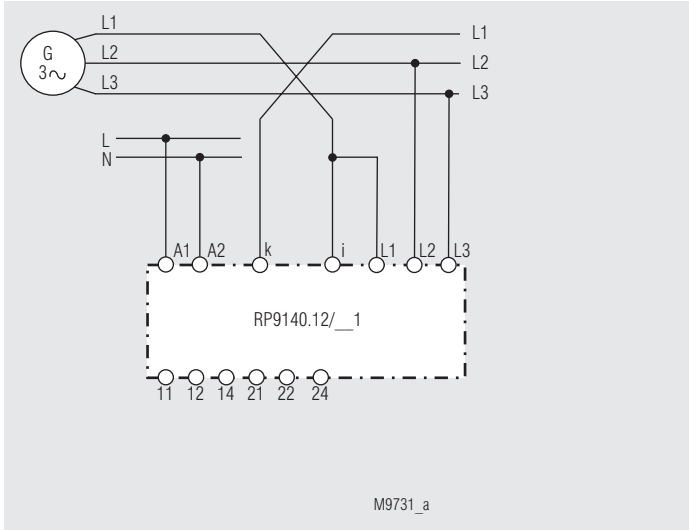

For 3-phase connection without N

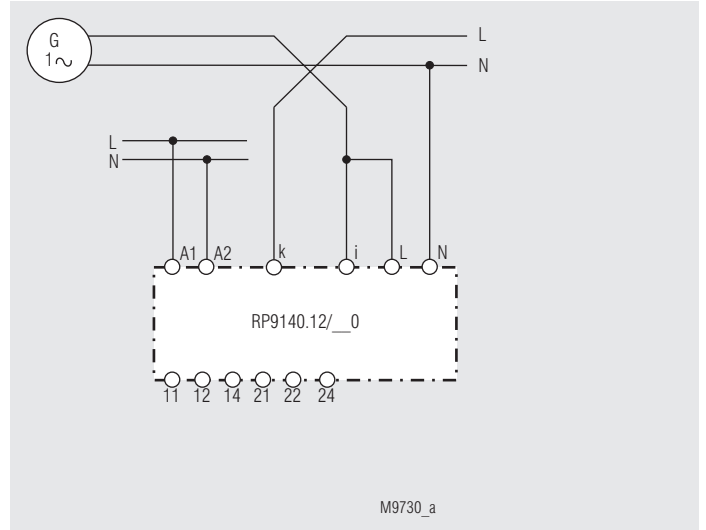

For single or 3-phase connection without N

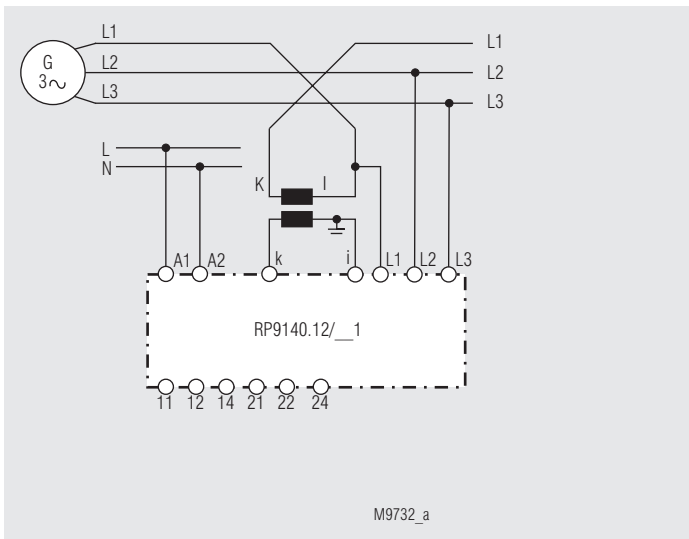

For 3-phase connections with current transformer (external).

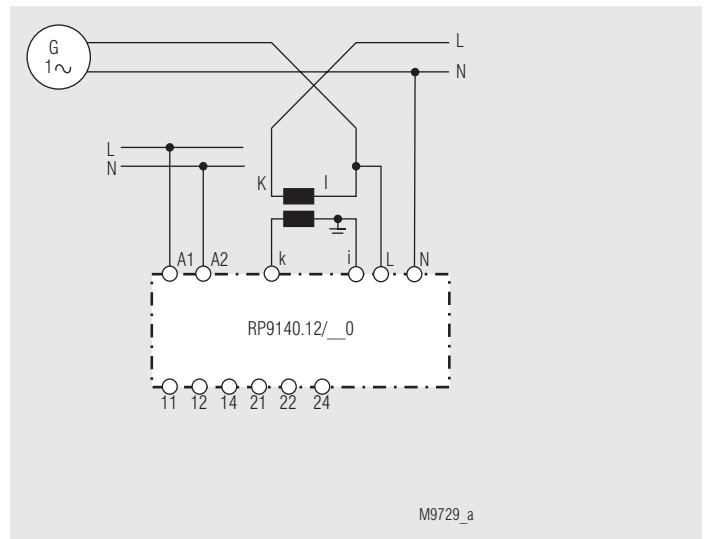

For single or 3-phase connections with current transformer (external)

