

Time Control Technique

MINITIMER
Timer, Off-delay
IK 9962, SK 9962

Translation
of the original instructions

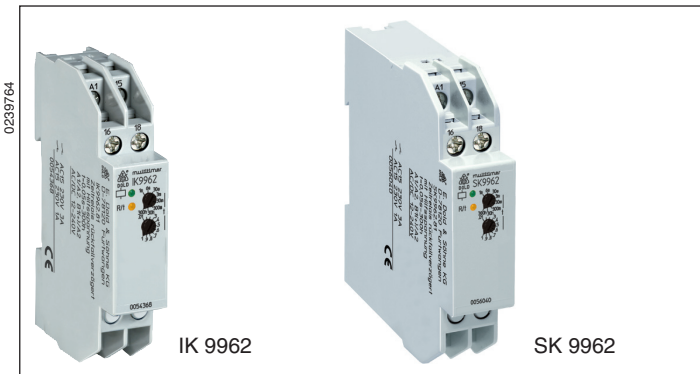

- OFF-delay relay with control signal according to EN 61812-1
- 8 time ranges from 0.05 s to 300 h selectable via rotational switch
- Voltage range AC/DC 12 ... 240 V for auxiliary supply and control input
- No voltfree control contact necessary
- Adjustment aid for quick setting of long time values
- LED indicators for operation, contact position and time delay
- 1 changeover contact
- As option connection of remote potentiometer 10 kΩ
- Devices available in 2 enclosure versions:
 - IK 9962: Depth 59 mm, with terminals at the bottom for installation systems and industrial distribution systems according to DIN 43880
 - SK 9962: Depth 98 mm, with terminals at the top for cabinets with mounting plate and cable duct
- 17.5 mm width

Function Diagram

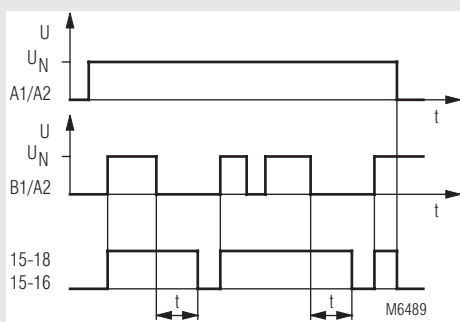

Approvals and Markings



Application

Time dependent controllers

Indicators

- | | |
|---------------------------------|---|
| Green LED: | On when auxiliary voltage connected |
| Yellow LED "R/t": | Shows status of output relay and time delay: |
| - LED off | Output relay not active; no time delay |
| - LED continuously on | Output relay active; no time delay (^= B1 input active) |
| - Flashing (long on, short off) | Output relay active; time delay |

Circuit Diagrams

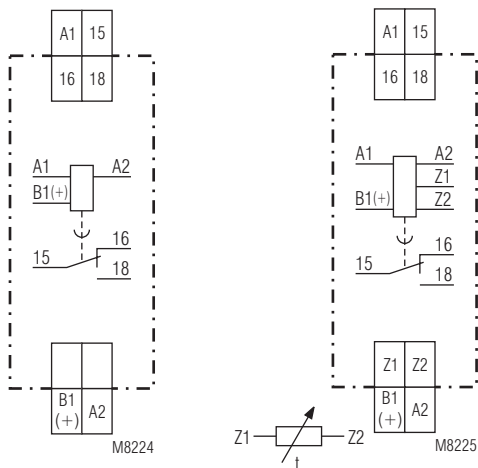

IK 9962.81
SK 9962.81

IK 9962.81/300
SK 9962.81/300

Connection Terminals

Terminal designation	Signal description
A1	L / +
A2	N / -
15, 16, 18	Changeover contact
B1(+)	Control input (control of time delay) Control with reference to A2
Z1, Z2 (only at variant /300)	Input to connect a remote potentiometer for time setting

Notes

Setting

A change of the settings for time range and time will be valid immediately. Please note, that a change of time range or time setting during elapse of time can lead to unintended switching of the output contacts.

Adjustment assistance

The flashing period of the yellow LED is $1 \text{ s} \pm 4\%$ and can be used to adjust the time. Especially on the lower end of scale and for long times it is suitable as the multiplication factors between the different time ranges are exact without tolerance.

Example:

The required time is 40 min. It has to be adjusted within the range 3 ... 300 min. The time check takes too long as several timing cycles would be necessary for a precise value.

For faster adjustment the setting is made to 0.03 ... 3 min. On this range the potentiometer should be set to 0.4 min (= 24 sec). With the right potentiometer setting the LED must show 24 flashing cycles. After that the time range is switched over to 3 ... 300 min and the setting is complete.

Remote potentiometer

With the variant IK/SK 9962.81/300 the time setting can also be made via remote potentiometer of 10 kOhms. It is connected to the terminals Z1-Z2. The corresponding potentiometer on the relay has to be set to min. If no remote potentiometer is required the terminals Z1-Z2 have to be linked.

The wires to the remote potentiometer should be installed separately from the lines with mains voltage. If this is not possible, a screened cable is recommended where the shield is connected to Z1.

To terminals Z1 and Z2 no external voltage must be connected, as the unit might be damaged.

Terminals Z1-Z2 do not have a galvanic separation to terminals A1/A2!

Control input B1

The unit needs a continuously connected auxiliary supply on A1-A2. The timing is controlled via input B1. The control unit B1 (+ with DC) has to be supplied with voltage against A2. The control signal could be the same as the auxiliary/control voltage of A1 or any other voltage between 12 and 240 V AC or DC. Operating a parallel load (e. g. contactor) between B1 and A2 is allowed.

Setting

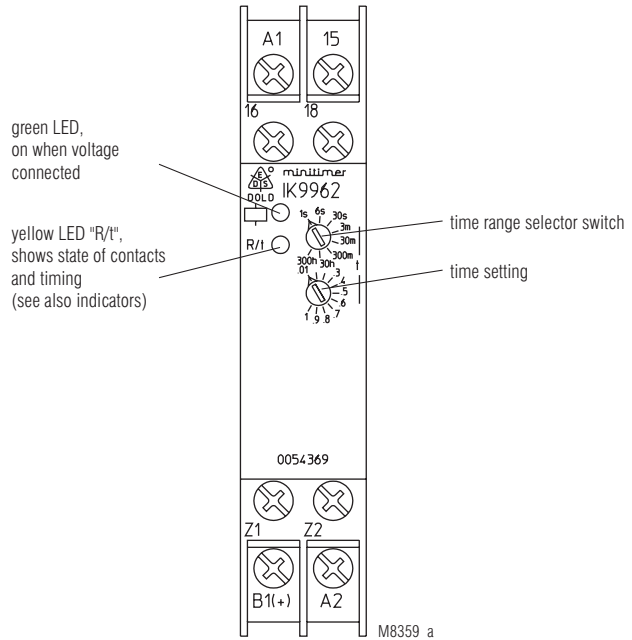

Technical Data

Time circuit

Time ranges:	8 time ranges settable via rotational switch: 0.05 ... 1 s 0.3 ... 30 min 0.06 ... 6 s 3 ... 300 min 0.3 ... 30 s 0.3 ... 30 h 0.03 ... 3 min 3 ... 300 h Continuous, 1:100 on relative scale
---------------------	--

Time setting:

Recovery time:

At DC 24 V:	Approx. 15 ms
At DC 240 V:	Approx. 50 ms
At AC 230 V:	Approx. 80 ms

Minimum on time (B1):

AC 50 Hz:	Approx. 48 ms
DC:	Approx. 40 ms

Repeat accuracy:

± 0.5 % of selected end of scale value + 20 ms

Voltage and temperature influence:

≤ 1 % with the complete operating range

Input

Auxiliary voltage U_H:	AC/DC 12 ... 240 V
Voltage range:	0.8 ... 1.1 U_N
Frequency range (AC):	45 ... 400 Hz
Nominal consumption	
At AC 12 V:	Approx. 2.5 VA
At AC 24 V:	Approx. 3 VA
At AC 240 V:	Approx. 4.5 VA
At DC 12 V:	Approx. 1.5 W
At DC 24 V:	Approx. 1.5 W
At DC 240 V:	Approx. 1.5 W
Release voltage (A1/A2)	
AC 50 Hz:	Approx. 7.5 V
DC:	Approx. 7 V
Control voltage (B1/A2):	AC/DC 12 ... 240 V
Voltage range (B1/A2):	0.8 ... 1.1 U_N
Control current (B1):	Input resistance approx. 220 k Ω in series with diode
Release voltage (B1/A2)	
AC 50 Hz:	Approx. 5 V
DC:	Approx. 4 V

Output

Contacts	
IK/SK 9962.81:	1 changeover contact
Contact material:	AgNi
Measured nominal voltage:	AC 250 V
Thermal current I_{th}:	4 A (see see quadratic total current limit curve)
Switching capacity	
To AC 15	
NO contact:	3 A / AC 230 V IEC/EN 60947-5-1
NC contact:	1 A / AC 230 V IEC/EN 60947-5-1
To DC 13:	1 A / DC 24 V
Electrical life	
To AC 15 at 1 A, AC 230 V:	1.5 x 10 ⁶ switch. cycles IEC/EN 60947-5-1
Permissible switching frequency:	30000 switching cycles / h
Short circuit strength	
Max. fuse rating:	4 A gG / gL IEC/EN 60947-5-1
Mechanical life:	≥ 30 x 10 ⁶ switching cycles

Technical Data

General Data

Operating mode:	Continuous operation
Temperature range:	
Operation:	- 40 ... + 60 °C (higher temperature with limitations see quadratic total current limit curve)
Storage:	- 40 ... + 70 °C
Relative air humidity:	93 % at 40 °C
Altitude:	≤ 2000 m
Clearance and creepage distances	
Rated impulse voltage / pollution degree:	4 kV / 2 (basis insulation) IEC 60664-1 III
Overvoltage category:	
Insulation test voltage, type test:	2.5 kV; 1 min
EMC	
Electrostatic discharge:	6 kV (contact) IEC/EN 61000-4-2 8 kV (air) IEC/EN 61000-4-2
HF irradiation	
80 MHz ... 1 GHz:	20 V / m IEC/EN 61000-4-3
1 GHz ... 2.7 GHz:	10 V / m IEC/EN 61000-4-3
Fast transients:	
A1/A2 and B1(+)/A2	4 kV IEC/EN 61000-4-4
Z1/Z2:	2 kV IEC/EN 61000-4-4
Surge voltages	
Between wires for power supply:	2 kV IEC/EN 61000-4-5
Between wire and ground:	4 kV IEC/EN 61000-4-5
HF-wire guided:	10 V IEC/EN 61000-4-6
Interference suppression	
IK 9962:	Limit value class B EN 55011
IK 9962/300:	Limit value class A*)

*) The device is designed for the usage under industrial conditions (Class A, EN 55011). When connected to a low voltage public system (Class B, EN 55011) radio interference can be generated. To avoid this, appropriate measures have to be taken

Degree of protection

Housing:	IP 40 IEC/EN 60529
Terminals:	IP 20 IEC/EN 60529

Housing:

Thermoplastic with V0 behaviour according to UL subject 94

Vibration resistance:

Amplitude 0.35 mm, frequency 10 ... 55 Hz, IEC/EN 60068-2-6 40 / 060 / 04 IEC/EN 60068-1

Climate resistance:

Terminal designation:

EN 50005

Wire connection:

Cross section: 2 x 2.5 mm² solid or 2 x 1.5 mm² stranded wire with sleeve 10 mm

Stripping length:

Wire fixing: Flat terminals with self-lifting clamping piece IEC/EN 60999-1 0.8 Nm

Fixing torque:

Mounting: DIN rail IEC/EN 60715

Weight:

IK 9962:	Approx. 65 g
SK 9962:	Approx. 84 g

Dimensions

Width x height x depth:

IK 9962:	17.5 x 90 x 59 mm
SK 9962:	17.5 x 90 x 98 mm

Standard Types

IK 9962.81 AC/DC 12 ... 240 V 0.05 ... 300 h

- Article number: 0054368
- Output: 1 changeover contact
 - Auxiliary voltage U_H : AC/DC 12 ... 240 V
 - Time ranges: 0.05 ... 300 h
 - Width: 17.5 mm

SK 9962.81 AC/DC 12 ... 240 V 0.05 ... 300 h

- Article number: 0056040
- Output: 1 changeover contact
 - Auxiliary voltage U_H : AC/DC 12 ... 240 V
 - Time ranges: 0.05 ... 300 h
 - Width: 17.5 mm

Variant

IK/SK 9962.81/300: Connection facility for a remote potentiometer 10 k Ω to adjust the time

Ordering example for variant

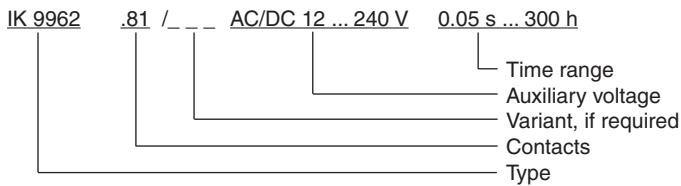

Characteristics

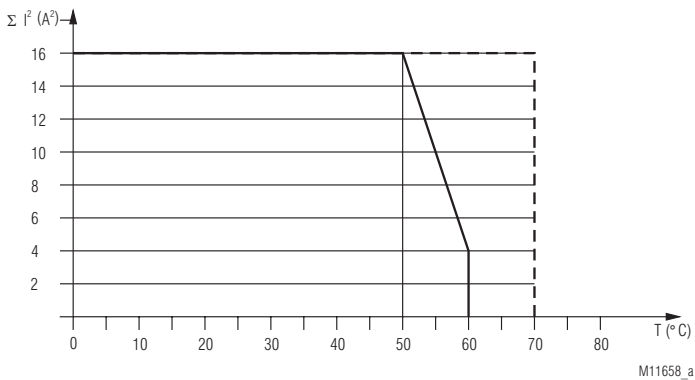

--- device mounted away from heat generation components.

— device mounted without distance heated by devices with same load.

Connection Examples

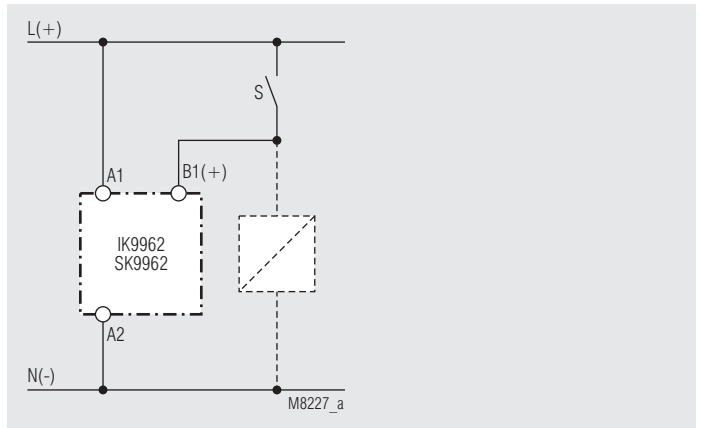
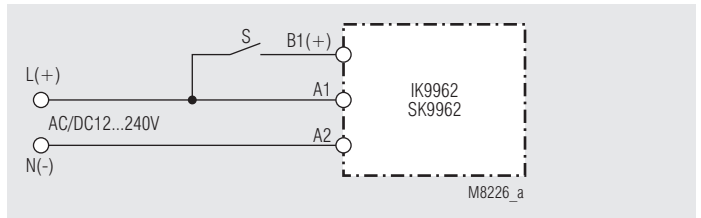

Control with parallel connected load

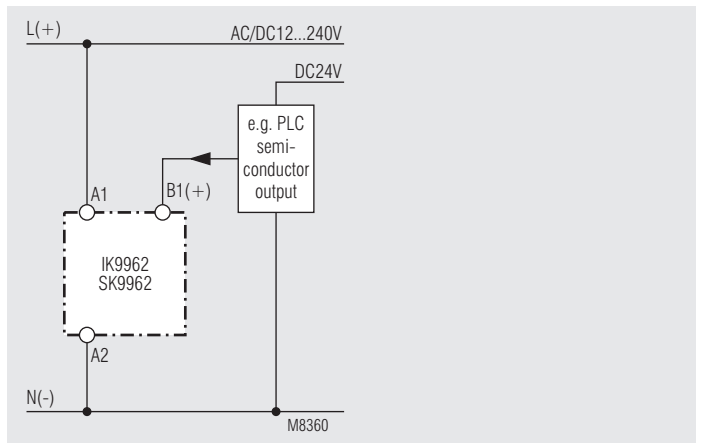

Connection with 2 different control voltages

Accessories

AD 3:

External potentiometer 10 k Ω
Artikelnummer: 0028962

The external potentiometer is used for remote setting of the time delay. The internal potentiometer of the timer must be set to min. time delay.

Degree of protection front side:

IP 40

