

- According to DIN EN 61810-1, DIN EN 61810-3 (Type A resp. Type B)
- With forcibly guided contacts
- Clearance and creepage distances:  
Contact-coil  $\geq 8$  mm  
**Version OA 5667.16 with double and reinforced insulation**
- Low rated power consumption
- High mechanical service life
- Compact size, small height

### Applications

- Switchgear for safety applications
- Press controls

### Approvals and Markings

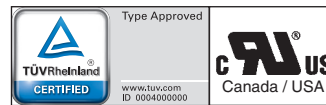

### Technical Data

Relaistyp		OA 5667.12	OA 5667.16
<b>1.0 Relay coil</b>			
1.1 Nominal voltage	DC V	6, 12, 24, 48, 60, 110	
1.2 Nominal consumption	W	0.75	
1.11 Voltage range	$U_N$	0.75 ... 1.3	
1.13 Holding Power (at 0.5 x $U_N$ )	W	0.19	
<b>2.0 Contacts</b>			
2.1 Contact arrangement		2 changeover contacts (Type B)	1 NO, 1 NC (Type A)
2.2 Contact material		AgSnO <sub>2</sub> + 0.2 $\mu$ m Au; AgNi + 0.2 $\mu$ m Au, AgNi + 5 $\mu$ m Au	
2.3 Rated insulation voltage	AC V	250	
Switching voltage min./max.	V	AC/DC 10 / DC 250, AC 400 (AC/DC 2 V / 60 V) <sup>1)</sup>	
2.4 Limiting continuous current $I_{th}$	A	2 x 6 (see operating voltage limit curve)	
Switching current min./max.	A	10 mA <sup>3)</sup> / 6 (2 mA / 0.3 A) <sup>1)</sup>	
2.5 Switching power min./max.	VA	0.1 / 1 500 (10 mVA / 12 VA) <sup>1)</sup>	
Switching power min./max.	W	0.1 / 200 (10 mW / 12 W) <sup>1)</sup> (s. limit curve for arc-free operation)	
2.6 Switching capacity to IEC/EN 60947-5-1			
AC 15 <sup>4)</sup>	AC V/A	NO: 250 / 3	NC: 250 / 1
AC 15 <sup>5)</sup>	AC V/A	NO: 250 / 3	NC: 250 / 1
DC 13 <sup>4)</sup>	DC V/A	NO: 24 / 2	NC: 24 / 1
DC 13 <sup>4)</sup> at 0.1 Hz to UL 508	DC V/A	NO: 24 / 4	NC: 24 / 3
		R300	
2.7 Electrical life	Switching cycles	at 1 s On, 1 s Off (see contacts service life)	
at AC 230 V, 5 A, $\cos\phi = 1$	Switching cycles	$> 10^5$ AgNi 10	$> 1.25 \times 10^5$ AgSnO <sub>2</sub>
2.8 Switching frequency max.	Switching cycles/s	10	
2.9 Response time / Release time	ms	Typically 10 / Typically 6	
2.10 Contact force NO / NC	cN	$\geq 20$ / $\geq 8$	
2.14 Contact gap	mm	$> 0.5$ <sup>2)</sup>	
<b>3.0 Other</b>			
3.1 Mechanical life	Switching cycles	$\geq 10^7$	
3.2 Temperature range	$^{\circ}$ C	- 40 ... + 85	
3.3 Degree of protection, housing		Solder line proof RT II	
3.4 Test procedure		A (group mounting)	
3.5 Vibration resistance		10 ... < 60 Hz; 0,35 mm Amplitude IEC/EN 60068-2-6 60 ... 200 Hz, $\leq 4g$ (all contacts) IEC/EN 60068-2-6	
3.6 Climate resistance		40 / 085 / 04; A/B/D IEC/EN 60068-1	
3.7 Short circuit strength 1 kA / AC 250 V	AgNi or AgSnO <sub>2</sub>	6 A gG / gL IEC/EN 60947-5-1	

<sup>1)</sup> Values for AgNi-contacts + 5  $\mu$ m Au  
<sup>4)</sup> Values for AgNi-contacts

<sup>2)</sup> Over entire service life acc. to DIN EN 61810-3  
<sup>5)</sup> Values for AgSnO<sub>2</sub>-contacts

<sup>3)</sup> Typical values

## Technical Data

3.8	Insulation acc. to IEC 60664-1, EN 50178		OA 5667.12	OA 5667.16
	Rated insulation voltage	AC V	250	250
	Pollution degree		3	3
	Overtoltage category		III	III
	Test voltage			
	Contact-coil (1 min)	AC kV eff.	≥ 4	≥ 4
	Contact-contact (1 min)	AC kV eff.	≥ 2.5	≥ 4
	Contact open (1 min)	AC kV eff.	≥ 1.5	≥ 1.5
	Transient voltage			
	Contact-coil (1.2 - 50 μs)	kV	≥ 6	≥ 6
	Clearance and creepage distances			
	Contact-coil	mm	≥ 8	≥ 8
	Contact-contact	mm	≥ 4.5	≥ 8
3.9	Weight	g	approx. 17	
<b>4.0 Packing</b>				
4.1	On cardboard	Piece	24	
4.2	In case package	Piece	240	
<b>5.0 Solder method</b>				
5.1	Solder method /-temperature /-duration	°C / s	Wave soldering / 260 / 5	

## Design Versions

U <sub>N</sub> DC V	Voltage range (DC V)	Resistance at 20°C	AgSnO <sub>2</sub> -contacts + 0,2 μm Au		AgNi10-contacts + 0,2 μm Au		AgNi10-contacts + 5 μm Au	
			OA 5667.12 2 C/O	OA 5667.16 1 NO / 1 NC	OA 5667.12 2 C/O	OA 5667.16 1 NO / 1 NC	OA 5667.12 2 C/O	OA 5667.16 1 NO / 1 NC
6	4.5 ... 7.8	48	2801	2831	2811	2841	2821	2851
12	9.0 ... 15.6	183	2802	2832	2812	2842	2822	2852
24	18.0 ... 31.2	750	2803	2833	2813	2843	2823	2853
48	36.0 ... 62.4	3 200	2804	2834	2814	2844	2824	2854
60	45.0 ... 78.0	4 700	2805	2835	2815	2845	2825	2855
110	82.5 ... 143.5	15 300	2806	2836	2816	2846	2826	2856

## Ordering example

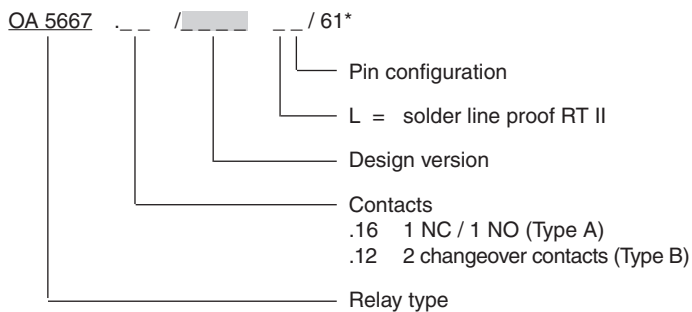

## Note

For the use and processing of our PCB relays, please refer to the **application and processing instructions** at [www.dold.com](http://www.dold.com)

\* /61 cURus approval

Characteristics

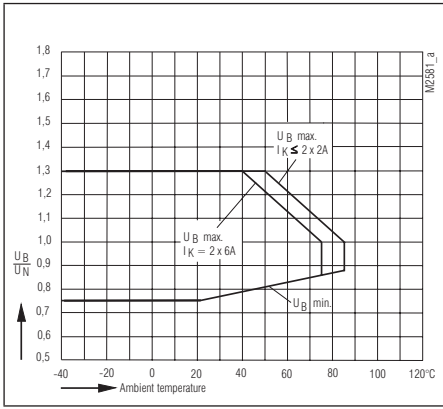

Operating voltage limit curve

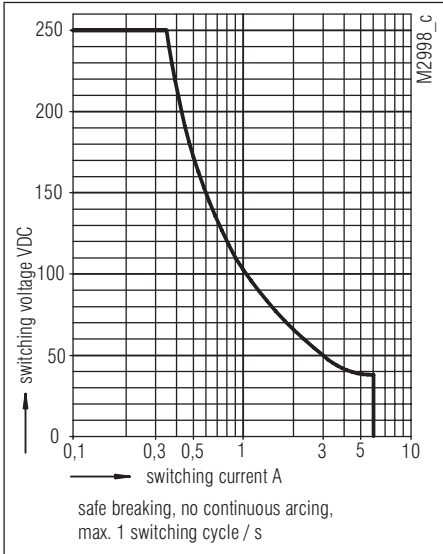

Arc limit curve

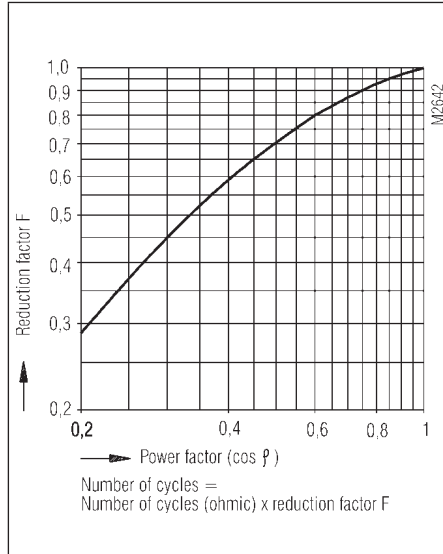

Reduction factor for inductive loads

Electrical life of the output contacts determined by  
DIN EN 60947-5-1 / Annex C.3

M4727\_a

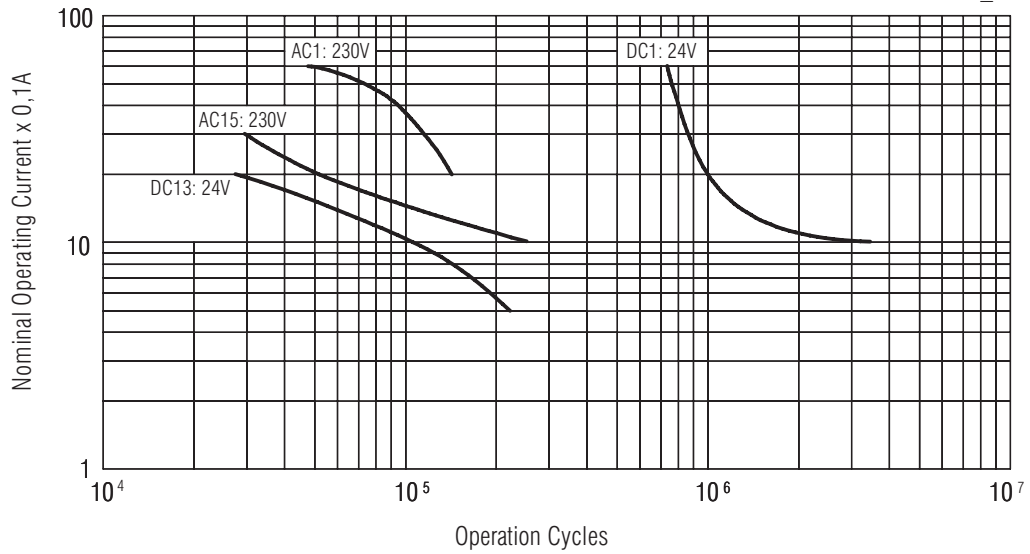

Electrical life

Drilling plan (solder side)

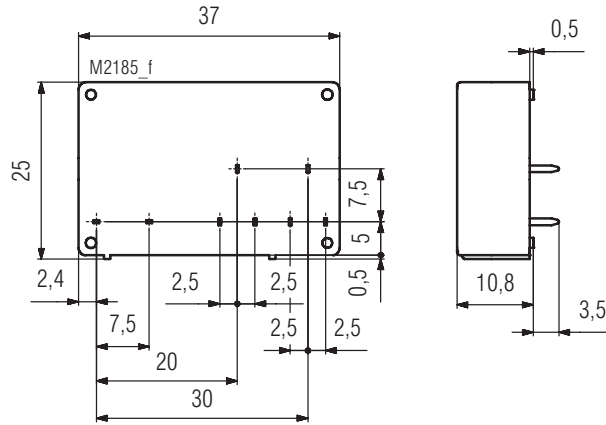
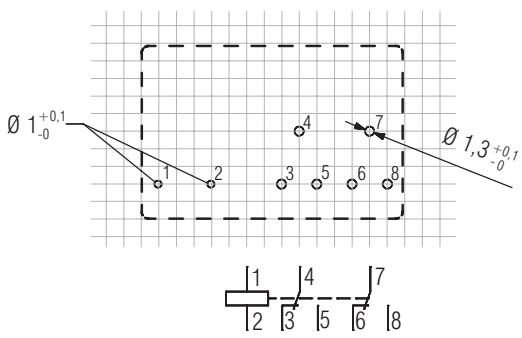

OA 5667.12/...L1  
OA 5667.20/...L1 contact 6 not fitted

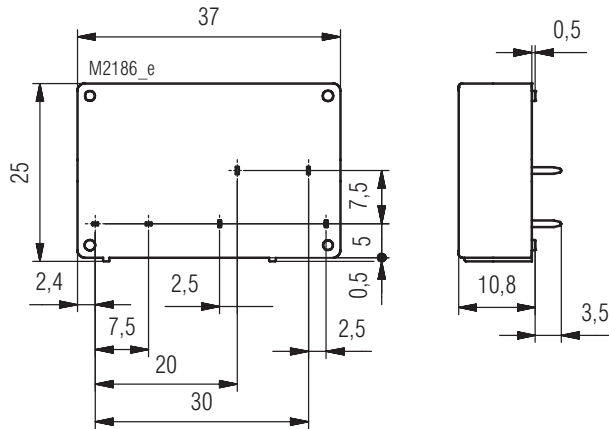
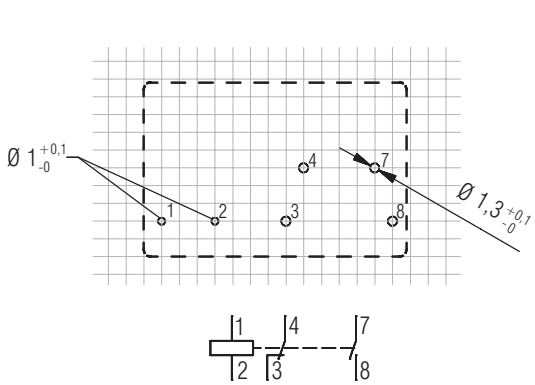

OA 5667.16/...L1

Connection for basic grid dimensions 2.5 mm as well as 2.54 mm according to IEC/EN 60097 and IEC 60326 average