



Ex safety switch with separate actuator Ex ES 97 AZ-02 -60°C Material number: 1440509

Features/Options:

- Ex zone 1 and 21
- Thermoplastic enclosure
- Cold-resistant down to -60 °C
- High degree of protection IP 66 / IP 67 / IP 69

- Mounting details to EN 50047
- Wiring compartment
- Double insulated

Notes

- 1 Ex"e" cable gland M20x1.5 included in delivery
- The actuator is not included in the delivery of the switches

Dimensions

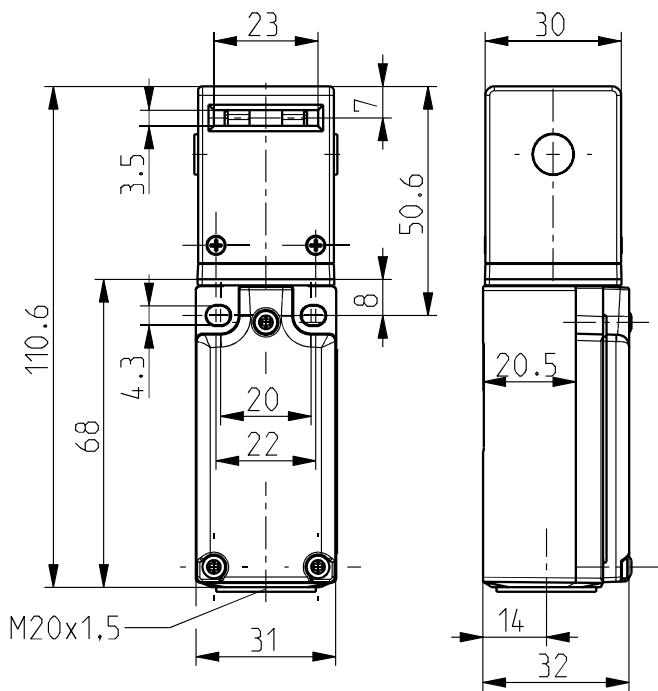

Technical data





Applied standards	EN 60947-5-1, EN 60079-0, EN 60079-1, EN 60079-7, EN 60079-31, EN ISO 13849-1, EN ISO 14119
Enclosure	thermoplastic, glass-fibre reinforced, impact resistant, self-extinguishing UL 94 V-0
Cover	thermoset, glass-fibre reinforced, impact resistant, self-extinguishing UL 94 V-0
Sealing	silicone
Switch type	type 2
Coding level	low coding
Tightening torque	cover screws: 0.4 ... 0.45 Nm connecting thread of cable gland: max. 2 Nm cap nut of cable gland: max. 5 Nm
Degree of protection	IP 66 to EN 60079-0 + IEC/EN 60529 (... -60 °C) IP 67 to EN 60079-0 + IEC/EN 60529 (... -20 °C) IP 67 / IP 69 to IEC/EN 60529 IP 69K to ISO 20653
B _{10d} (10 % load)	2 million
T _M	max. 20 years
Switch insert	1 x 8080/1-3
Contact material	Silver, nickel-plated
Switching system	slow action, positive break NC contacts
Switching elements	2 NC contacts, type Zb
Connection	screw connection terminals

Errors and omissions excepted.



Ex safety switch with separate actuator
 Ex ES 97 AZ-02 -60°C
 Material number: 1440509

Technical data

Cable cross-section	min. 0,75 mm ² / AWG 18, max. 1,5 mm ² / AWG 16, incl. conductor ferrules
Cable entry	M20 x 1,5; screwing depth max. 9 mm; use only Ex approved and certified cable glands with min. degree of protection IP 66 and suitable for the specified ambient temperature range
Clamping range	7 ... 12 mm
Utilisation category	AC-15
Rated operating current I _e	max. 2 A or 4 A <input type="checkbox"/>
Rated operating voltage U _e	max. 400 VAC, max. 250 VAC for unequal potential
Mechanical life	> 1 million operations
Impact energy	max. 7 J
Temperature class	T6
Ambient temperature	-60 °C ... +55 °C max. 4 A, +60 °C max. 2 A
Short-circuit protection	2 A / 4 A gG/gN fuse
Ex marking	<p>⊕ II 2G Ex db eb IIC T6 Gb, ⊕ II 2D Ex tb IIIC T80 °C Db IECEx Ex db eb IIC T6 Gb, Ex tb IIIC T80 °C Db</p>
Approvals	<p>BVS 16 ATEX E 052 IECEx BVS 16.0052</p> <p>     </p>
Weight	160 g

Contact diagram

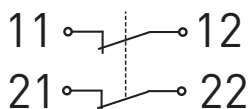



Ex safety switch with separate actuator
Ex ES 97 AZ-02 -60°C
Material number: 1440509

Switching diagram

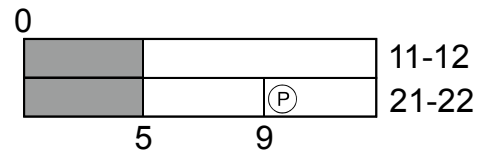

Ⓟ Positive break travel/angle

Note

Inserted position of actuator = 0 in switching diagram.
The actuator is not included with the switches.