



Pull-wire switch

ZS 75 1Ö/1S / 120-180 N

Material number: 1048349 (Material number old: 75141905)

Features/Options:

- Metal enclosure
- 2 contacts
- Wire length up to 130 m
- Adjustable spring force: 120-180 N
- Wire pull and breakage detection
- Without mechanical latching

Notes

- At 5 m distance intermediate wire supports are required. One wire thimble is provided.

Dimensions

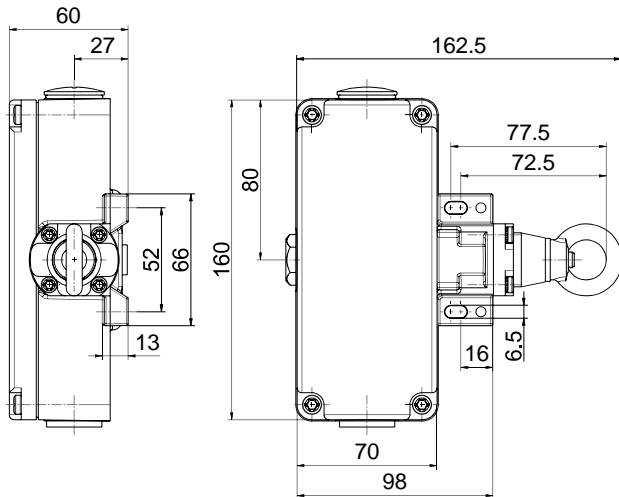

Technical data

Applied standards	EN ISO 13849-1, EN 60947-5-1
Enclosure	aluminium die-cast, powder-coated
Cover	aluminium die-cast, powder-coated
Degree of protection	IP 54 to IEC/EN 60529
B_{10d} (10 % load)	2 million
T_M	max. 20 years
Contact material	silver
Switching elements	1 NC/1 NO contact
Switching system	snap action, positive break NC contacts \ominus
Connection	screw connection terminals
Cable cross-section	max. 2.5 mm ² (incl. conductor ferrules)
Cable entry	2 x M25 x 1.5
Rated impulse withstand voltage U_{imp}	6 kV
Rated insulation voltage U_i	400 V
Conventional thermal current I_{the}	6 A
Utilisation category	AC-15
Rated operating current/voltage I_e/U_e	6 A/400 VAC
Short-circuit protection	6 A gG/gN fuse
Ambient temperature	-25 °C ... +70 °C
Mechanical life	> 1 million operations
Max. wire length	130 m

Errors and omissions excepted.



Pull-wire switch

ZS 75 1Ö/1S / 120-180 N

Material number: 1048349 (Material number old: 75141905)

Technical data

Approvals



Weight

870 g

Contact diagram

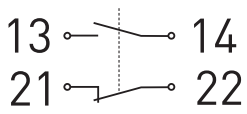

Switching diagram

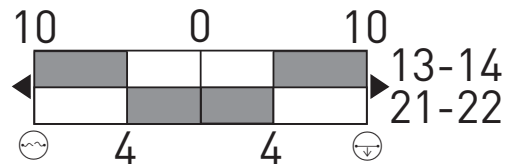

- Wire breakage detection
- Wire pull detection