



## Ex emergency pull-wire switch

Ex ZS 75 S 2Ö/2S VD - 3m

Material number: 1173241 (Material number old: 75330301)

### Features/Options:

- Ex zone 1 and 21
- Metal enclosure
- 4 contacts
- Wire length up to 2 x 100 m

### Notes

- At 4 m distance intermediate wire supports are required. Two compensation springs type ZS 73/75 S must be installed, see accessories.

- Release by push button (VD)
- Wire pull and breakage detection
- Attention: Please state required international approvals with your order!

### Dimensions

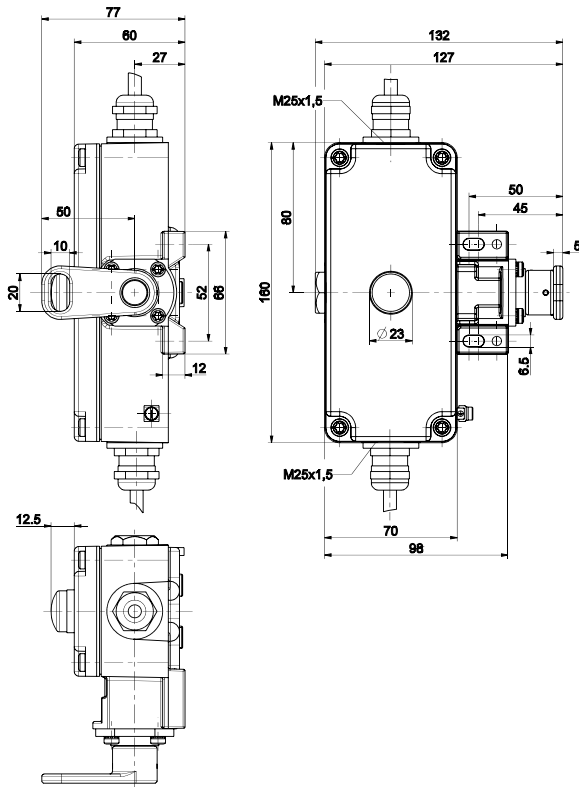

### Technical data

Applied standards	EN 60947-5-1, EN 60947-5-5, EN 60079-0, EN 60079-1, EN 60079-31, EN ISO 13850, EN ISO 13849-1
Enclosure	aluminium die-cast, powder-coated
Cover	aluminium die-cast, powder-coated
Degree of protection	IP 65 to IEC/EN 60529
B <sub>10d</sub> (10 % load)	200 000
T <sub>M</sub>	max. 20 years
Switch insert	2 x Ex 14
Contact material	silver
Switching system	slow action, positive break NC contacts $\ominus$
Switching elements	2 NC/2 NO contacts, type Zb
Connection	pre-wired cable H05VV-F
Cable cross-section	4 x 0.75 mm <sup>2</sup> (incl. conductor ferrules)
Cable length	3 m
Rated impulse withstand voltage U <sub>imp</sub>	4 kV
Rated insulation voltage U <sub>i</sub>	250 V
Conventional thermal current I <sub>the</sub>	T6: 6 A, T5: 3 A
Utilisation category	AC-15; DC-13
Rated operating current/voltage I <sub>e</sub> /U <sub>e</sub>	6 A/250 VAC; 0.25 A/230 VDC

Errors and omissions excepted.









## Ex emergency pull-wire switch

Ex ZS 75 S 2Ö/2S VD - 3m



Material number: 1173241 (Material number old: 75330301)

### Technical data

Short-circuit protection	6 A gG/gN fuse
Ambient temperature	T6: -20 °C ... +65 °C, T5: -20 °C ... +75 °C, +90 °C with max. 3 A
Mechanical life	> 100 000 operations
Max. wire length	2 x 100 m
Impact energy	max. 7 J
Ex marking	⊕ II 2G Ex d IIC T6/T5 Gb, ⊕ II 2D Ex tb IIIC T80 °C/T95 °C Db IECEX Ex d IIC T6/T5 Gb, Ex tb IIIC T80 °C/T95 °C Db
Approvals	PTB 11 ATEX 1003 X IECEX PTB 07.0034 X       
Weight	1622 g

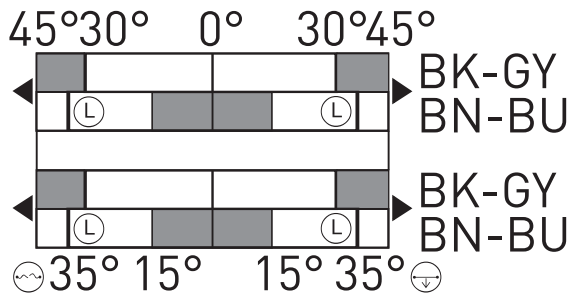
### Switching diagram



-  Latching point
-  Wire breakage detection
-  Wire pull detection

Errors and omissions excepted.