



Emergency pull-wire switch Extreme ZS 73 1Ö/1S WVD / 120-180 N Niro hard-coated Extreme Material number: 1048231 (Material number old: 73142906)

Features/Options:

- Pull-wire unit and screws made of stainless steel 1.4305, hard-coated enclosure
- Metal enclosure
- 2 contacts
- Wire length up to 130 m
- Adjustable spring force: 120-180 N

- Release by push button (VD)
- Wire pull and breakage detection
- Watertight collar W for protection against penetration of dirt
- Attention: Please state required international approvals with your order!

Notes

- At 5 m distance intermediate wire supports are required. One wire thimble is provided.

Dimensions

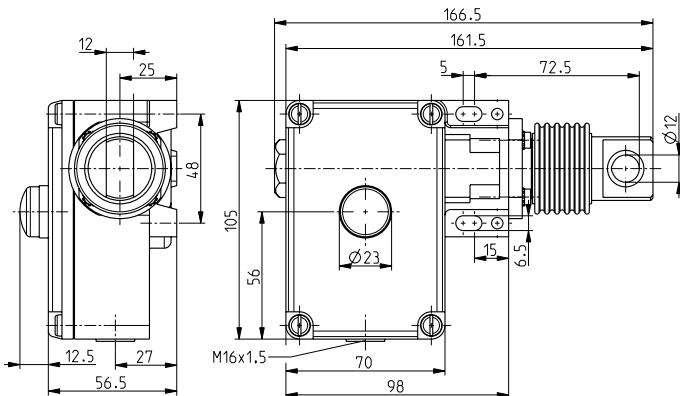

Technical data

Applied standards	EN 60947-5-1, EN 60947-5-5, EN ISO 13850, EN ISO 13849-1
Enclosure	aluminium die-cast, hard-coated, enamel finish
Cover	thermoplastic, glass-fibre reinforced, impact resistant, self-extinguishing UL 94 V-0
Degree of protection	IP 65 to IEC/EN 60529
B _{10d} (10 % load)	100 000
T _M	max. 20 years
Contact material	silver
Switching elements	1 NC/1 NO contact
Switching system	snap action, positive break NC contacts ⊖
Connection	screw connection terminals
Cable cross-section	min. 0.5 mm ² , max. 2.5 mm ² (incl. conductor ferrules)
Stripping length	6 mm
Cable entry	1 x M16 x 1.5
Rated impulse withstand voltage U _{imp}	6 kV
Rated insulation voltage U _i	400 V
Conventional thermal current I _{the}	6 A
Utilisation category	AC-15
Rated operating current/voltage I _e /U _e	6 A/400 VAC

Errors and omissions excepted.



Emergency pull-wire switch Extreme
 ZS 73 1Ö/1S WVD / 120-180 N Niro hard-coated Extreme
 Material number: 1048231 (Material number old: 73142906)

Technical data

Short-circuit protection	6 A gG/gN fuse
Ambient temperature	-25 °C ... +70 °C
Mechanical life	> 100 000 operations
Max. wire length	130 m
Approvals	
Weight	815 g

Switching diagram

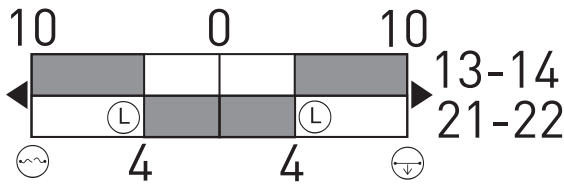

- Ⓛ Latching point
- ⊖ Wire breakage detection
- ⊕ Wire pull detection

Contact diagram

