



Solenoid interlock STM 295 1ÖS/1ÖS-A

Material number: 1183003 (Material number old: 95353001)

Features/Options:

- Thermoplastic enclosure
- Double insulated
- Power-to-lock principle
- Locking force 1000 N
- Wiring compartment
- With LED

Notes

- The actuator is not included in the delivery of the switches

Dimensions

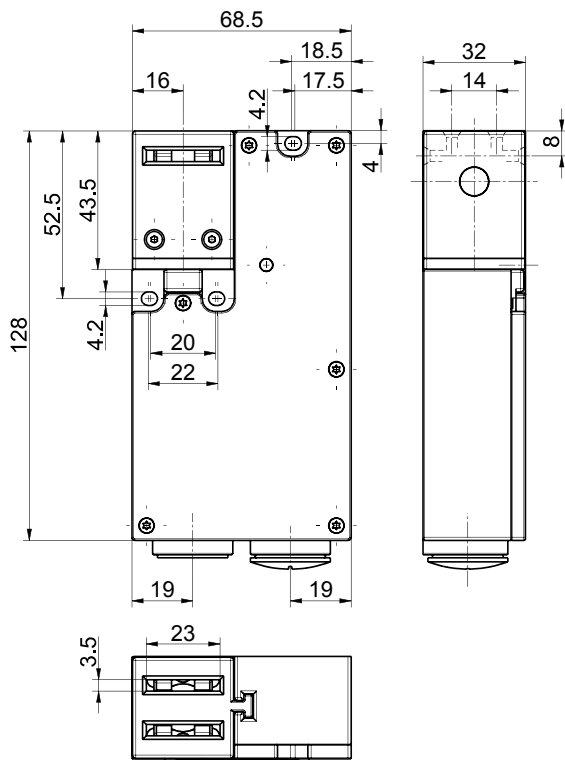

Technical data

Applied standards	EN ISO 13849-1, EN 60947-5-1, EN ISO 14119
Enclosure	thermoplastic, glass-fibre reinforced, impact resistant, self-extinguishing UL 94 V-0
Switch type	type 2
Coding level	low coding
Tightening torque	cover screws: 0.5 ... 0.6 Nm switch inserts M3 screw connection terminals: min. 0.6 Nm solenoid M3.5 screw connection terminals: min. 0.8 Nm
Degree of protection	IP 67 to IEC/EN 60529
B_{10d} (10 % load)	1 million
T_M	max. 20 years
Switching system	slow action, positive break NC contacts \ominus
Switching elements	1 NC/1 NO contact + 1 NC/1 NO contact, type Zb
Connection	screw connection terminals
Cable cross-section	min. 0.2 mm ² / AWG 24, max. 1.5 mm ² / AWG 16
Cable entry	2 x M20 x 1.5
Rated insulation voltage U_i	250 V
Rated impulse withstand voltage U_{imp}	4 kV
Conventional thermal current I_{the}	4 A
Utilisation category	AC-15; DC-13
Rated operating current/voltage I_e/U_e	enabling/signalling contacts: 4 A/250 VAC; 0.25 A/230 VDC; direct-current solenoid: 0.08 A / 24 VDC +10 %/-15 %

Errors and omissions excepted.



Solenoid interlock STM 295 1ÖS/1ÖS-A





Material number: 1183003 (Material number old: 95353001)

Technical data

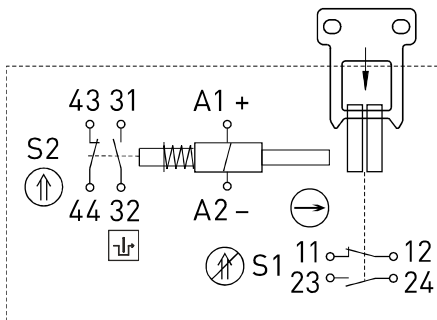
Short-circuit protection	6 A gG/gN fuse; direct-current solenoid: 2 A (slow blow)
Power consumption	max. 47 W (0.25 s)
Operation cycles	max. 1200/h
Mechanical life	> 500 000 operations
Locking force F_{max}	1000 N
Ambient temperature	-20 °C ... +55 °C
Approvals	
Weight	410 g

Contact diagram



-  positive break
-  actuated
-  not actuated
-  monitoring of the guard-lock to EN ISO 14119