



Magnetic sensor

RC 20 1S-2m

Material number: 1045783 (Material number old: 22020201)

Features/Options:

- Metal enclosure
- Long life
- 1 Reed contact
- Actuation from front and from side
- Switching distance up to 41 mm depending on the actuating magnet
- With pre-wired cable

Notes

- 2 mounting nuts are included in delivery
- The actuator is not included in the delivery of the switches

Dimensions

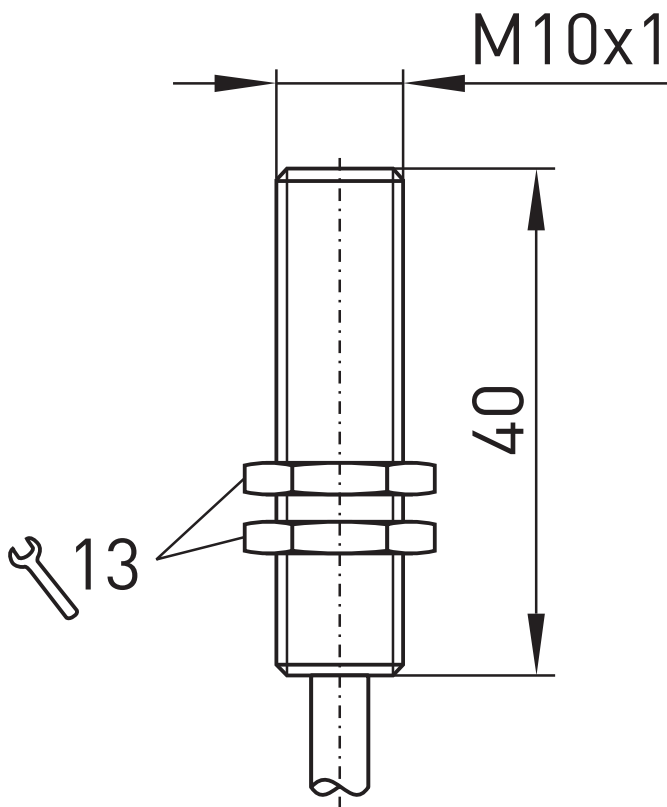

Technical data

Applied standards	EN 60947-5-2
Enclosure	brass, nickel
Degree of protection	IP 67 to IEC/EN 60529
Switching system	reed contacts
Switching elements	1 NO contact
Connection	Pre-wired cable PVC LiYY
Cable cross-section	2 x 0.34 mm ²
Cable length	2 m
Switching voltage	max. 250 VAC/DC
Switching current	max. 0.5 A
Switching capacity	max. 50 W/VA
Switching frequency	max. 200 Hz
Ambient temperature	-5 °C ... +70 °C
Mechanical life	10 ⁹ operations
Repeatability	± 0.02 mm
Vibration resistance	20 g
Weight	60 g

Errors and omissions excepted.



Magnetic sensor

RC 20 1S-2m

Material number: 1045783 (Material number old: 22020201)

Contact diagram

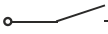
BU  BN