



Safety sensor Extreme RC Si M30 2Ö - 2m - Niro - IP69 Extreme Material number: 1188981 (Material number old: 23059201)

Features/Options:

- Version with higher degree of protection IP 69: suitable for cleaning with 80 °C hot water at 100 bar pressure at a distance of 100 mm from different directions
- Stainless steel enclosure
- Long life
- Reed contacts, coded
- Actuation from front
- Switching distance up to 10 mm
- With pre-wired cable

Notes

- 2 mounting nuts are included in delivery
- The actuator is not included in the delivery of the switches

Dimensions

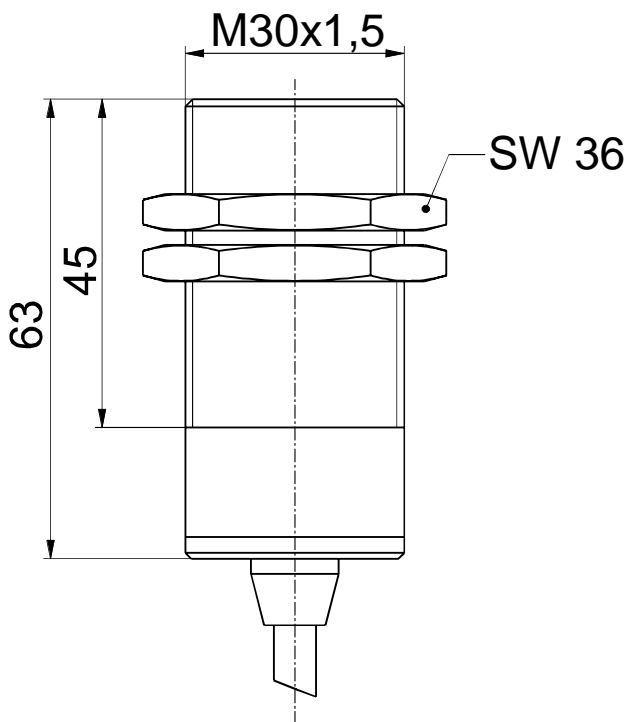

Technical data

Applied standards	EN ISO 13849-1, EN ISO 14119, EN 60947-5-2, EN 60947-5-3*
Enclosure	stainless steel 1.4539
Sensor type	type 4 interlocking device
Coding level	low coding
Tightening torque	mounting nut: max. 75 Nm
Degree of protection	IP 66, IP 67, IP 69 (IEC/EN 60529) / IP 69K (ISO 20653)
Safety-relevant data:	
EN ISO 13849-1	Performance Level PL e
Category	4
B _{10d} (10 % load)	20 million
T _M	max. 20 years
MTTF _d	> 100 years
DC/DC _{avg}	> 99 %
h _{op}	8 h/day
d _{op}	220 days/year
t _{zyklus}	20 s
Note	The safety-related data are only valid in combination with a safety module, e.g. SRM 21 RT2 (mat. no. 1179203).
Switching system	reed contacts
Switching elements	2 NC contacts
Connection	cable 4 x AWG 20

Errors and omissions excepted.



Safety sensor Extreme
 RC Si M30 2Ö - 2m - Niro - IP69 Extreme
 Material number: 1188981 (Material number old: 23059201)

Technical data

Cable cross-section	4 x 0.56 mm ²
Cable length	2 m
Switching voltage	max. 30 VDC
Rated operating current/ voltage I _e /U _e	max. 157 mA / 24 VDC
Utilisation category	DC-12
Voltage drop at I _e	max. 3.15 V
Short-circuit current I _k	max. 750 mA for 50 ms
Switching frequency	max. 5 Hz
Degree of pollution	3
Safety class	II
Rated switching distance s _n	10 mm
Assured switching distance »ON« s _{ao}	8 mm
Assured switching distance »OFF« s _{ar}	30 mm
Repeatability	± 0.5 mm
Hysteresis	approx. 14 mm
Ambient temperature	-20 °C ... +85 °C
Mechanical life	> 10 million operations
Approvals	
Weight	274 g

Contact diagram

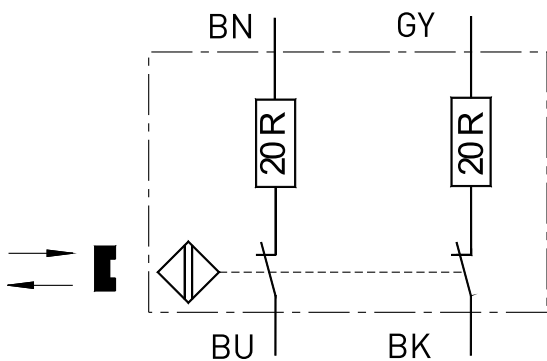

Axial misalignment

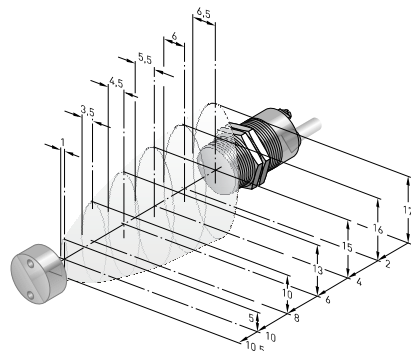

Errors and omissions excepted.