



Position switch EM 41 TF 1Ö/1S

Material number: 1046471 (Material number old: 41134001)

Features/Options:

- Metal enclosure
- Snap action, change-over contact with double break
- 3 cable entries M16 x 1.5
- Actuator: Spring rod with steel tip
- With rounded steel tip
- Spring rod can be actuated from any direction
- Elasticity of the spring allows for deflection above the max. switching angle

Dimensions

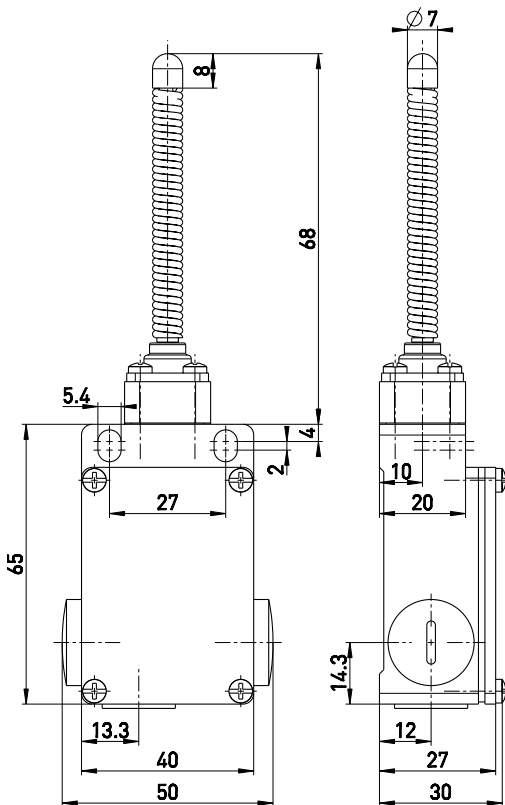

Technical data

Applied standards	EN 60947-5-1
Enclosure	aluminium die-cast, powder-coated
Degree of protection	IP 65 to IEC/EN 60529
Contact material	silver
Switching system	snap action
Switching elements	1 NC/1 NO contact, type Zb
Connection	screw connection terminals
Cable cross-section	max. 2.5 mm ² (incl. conductor ferrules)
Cable entry	3 x M16 x 1.5
Rated impulse withstand voltage U_{imp}	4 kV
Rated insulation voltage U_i	400 V
Conventional thermal current I_{the}	6 A
Utilisation category	AC-15
Rated operating current/voltage I_e/U_e	6 A/400 VAC
Short-circuit protection	6 A gG/gN fuse
Mechanical life	> 1 million operations
Operation cycles	max. 3600/h
Ambient temperature	-20 °C ... +80 °C
Repeat accuracy of switching points	± 0.1 mm

Approvals



Weight 160 g

Errors and omissions excepted.



Position switch
EM 41 TF 1Ö/1S

Material number: 1046471 (Material number old: 41134001)

Contact diagram

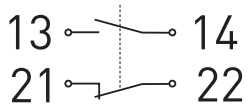

Switching diagram

