



Position switch with safety function

ES 14 WR 2Ö - 5m

Material number: 1045555 (Material number old: 14510001)

Features/Options:

- Thermoplastic enclosure
- Double insulated
- Mounting details to EN 50047
- Suitable for in-line mounting
- With pre-wired cable
- Actuator: Roller plunger with collar WR
- Actuating speed max. 0.5 m/s with a vertical actuating angle of 25°
- Metal roller
- Watertight collar for protection against penetration of dirt

Notes

- Actuator can be repositioned by 90° on request

Dimensions

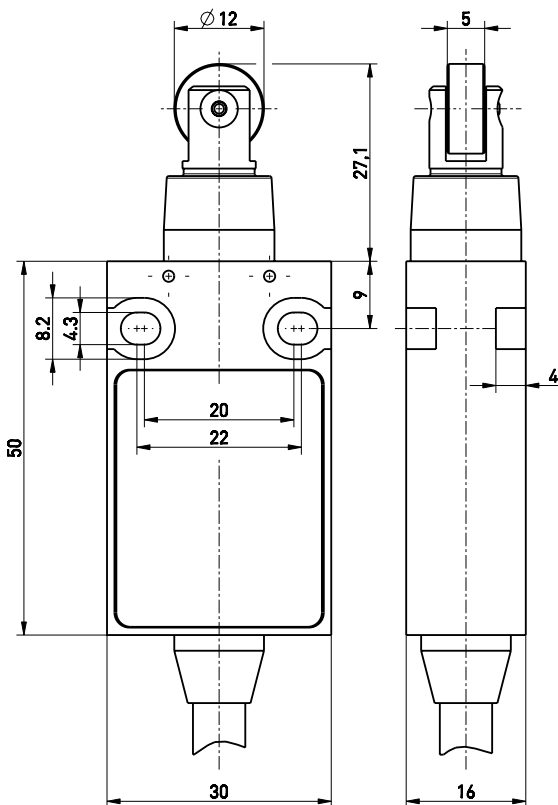

Technical data

Applied standards	EN ISO 13849-1, EN 60947-5-1, EN ISO 14119
Enclosure	thermoplastic, glass-fibre reinforced, impact resistant, self-extinguishing UL 94 V-0
Switch type	type 1
Coding level	no coding
Degree of protection	IP 67 to IEC/EN 60529
B_{10d} (10 % load)	2 million
T_M	max. 20 years
Contact material	silver
Switching system	slow action, positive break NC contacts \ominus
Switching elements	2 NC contacts, type Zb
Connection	pre-wired cable H05VV-F
Cable cross-section	4 x 0.75 mm ²
Cable length	5 m
Rated impulse withstand voltage U_{imp}	4 kV
Rated insulation voltage U_i	250 V
Conventional thermal current I_{the}	6 A
Rated operating current/voltage I_e/U_e	6 A/250 VAC; 0.25 A/230 VDC
Utilisation category	AC-15; DC-13
Short-circuit protection	6 A gG/gN fuse
Ambient temperature	-20 °C ... +75 °C

Errors and omissions excepted.



Position switch with safety function

ES 14 WR 2Ö - 5m

Material number: 1045555 (Material number old: 14510001)

Technical data

Mechanical life > 1 million operations

Operation cycles max. 1800/h

Repeat accuracy of switching points ± 0.1 mm

Contact opening max. 2 x 4 mm

Approvals



Weight 420 g

Contact diagram

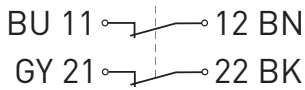

Switching diagram

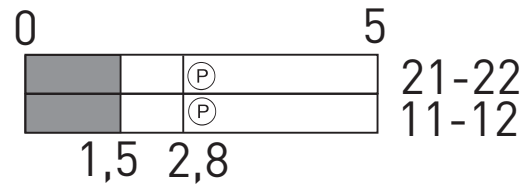

Ⓟ Positive break travel/angle