



Position switch with safety function ES 41 WR 2Ö

Material number: 1046527 (Material number old: 41510001)

Features/Options:

- Metal enclosure
- Slow action \ominus , 2 NC contacts with double break
- 3 cable entries M16 x 1.5
- Actuator: Roller plunger with collar WR
- Actuating speed max. 0.5 m/s with a vertical actuating angle of 25°

- Wear-resistant plastic roller
- Actuator can be repositioned by 4 x 90°
- Watertight collar for protection against penetration of dirt

Notes

- With metal roller available on request
- When used as safety switch, secure the enclosure against slipping with appropriate means, e.g. pinning.

Dimensions

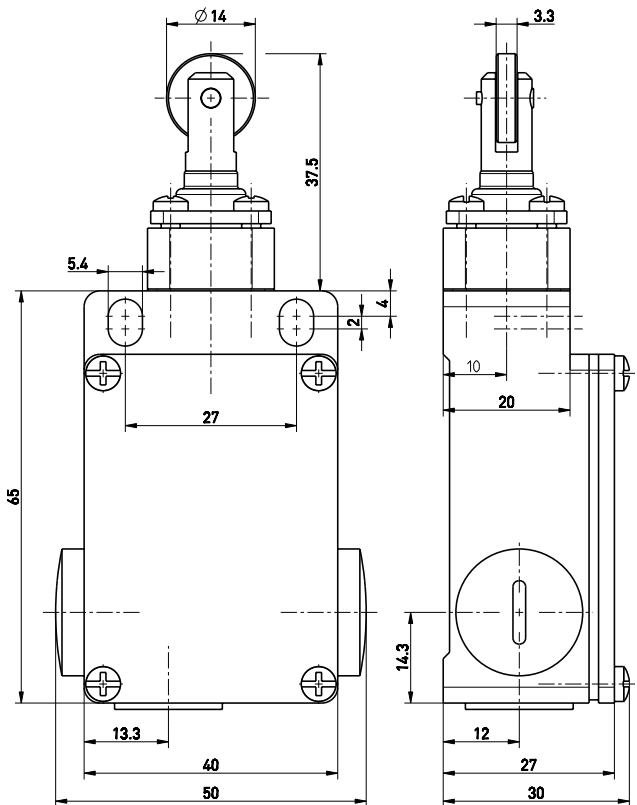

Technical data

Applied standards	EN ISO 13849-1, EN 60947-5-1, EN ISO 14119
Enclosure	aluminium die-cast, powder-coated
Switch type	type 1
Coding level	no coding
Degree of protection	IP 65 to IEC/EN 60529
B_{10d} (10 % load)	2 million
T_M	max. 20 years
Contact material	silver
Switching system	slow action, positive break NC contacts \ominus
Switching elements	2 NC contacts, type Zb
Connection	screw connection terminals
Cable cross-section	max. 2.5 mm ² (incl. conductor ferrules)
Cable entry	3 x M16 x 1.5
Rated impulse withstand voltage U_{imp}	4 kV
Rated insulation voltage U_i	400 V
Conventional thermal current I_{the}	6 A
Utilisation category	AC-15
Rated operating current/voltage I_e/U_e	6 A/400 VAC

Errors and omissions excepted.



Position switch with safety function

ES 41 WR 2Ö

Material number: 1046527 (Material number old: 41510001)

Technical data

Short-circuit protection	6 A gG/gN fuse
Mechanical life	> 1 million operations
Operation cycles	max. 3600/h
Ambient temperature	-20 °C ... +80 °C
Repeat accuracy of switching points	± 0.1 mm
Approvals	
Weight	156 g

Contact diagram

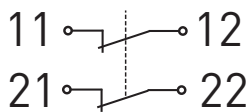

Switching diagram

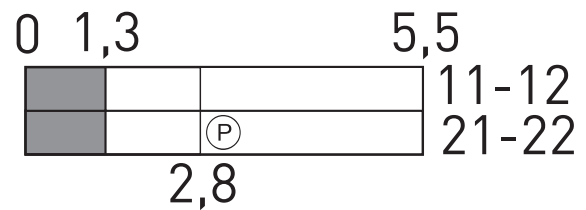

Ⓟ Positive break travel/angle