



## Safety switch with separate actuator

ST 14 S 2Ö - 2m

Material number: 1053988 (Material number old: 14553707)

### Features/Options:

- Thermoplastic enclosure
- Double insulated
- Version with cable entry on side
- With pre-wired cable

### Notes

- The actuator is not included in the delivery of the switches

### Dimensions

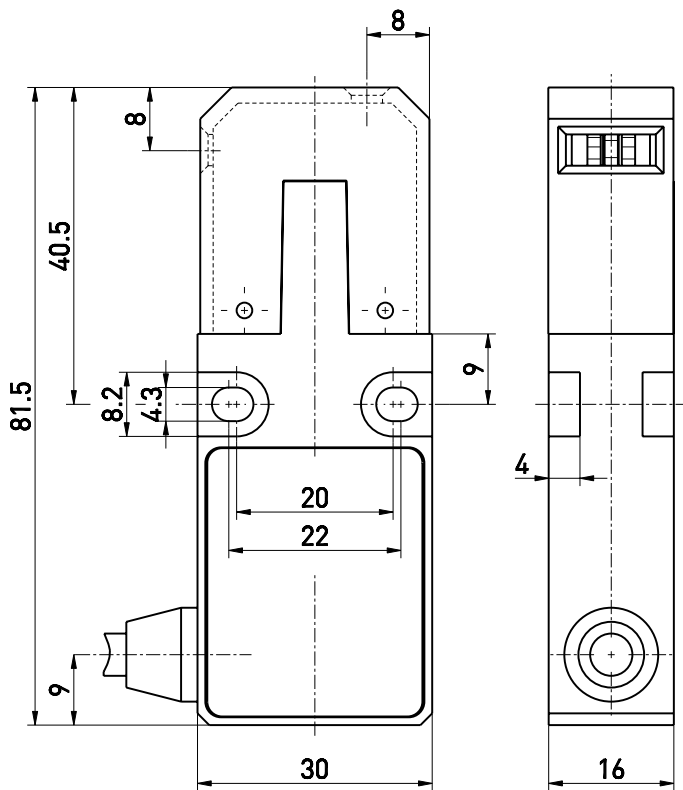

### Technical data

Applied standards	EN 60947-5-1, EN ISO 13849-1, EN ISO 14119, GS-ET-15
Enclosure	thermoplastic, glass-fibre reinforced, impact resistant, self-extinguishing UL 94 V-0
Switch type	type 2
Coding level	low coding
Tightening torque	enclosure mounting screws: max. 1.5 Nm
Degree of protection	IP 67 to IEC/EN 60529
B <sub>10d</sub> (10 % load)	2 million
T <sub>M</sub>	max. 20 years
Contact material	silver
Switching system	slow action, positive break NC contacts $\ominus$
Switching elements	2 NC contacts, type Zb
Connection	cable 4 x AWG 20 UL 2464
Cable diameter	5.4 mm $\pm$ 3%
Cable cross-section	4 x 0.56 mm <sup>2</sup>
Rated impulse withstand voltage U <sub>imp</sub>	4 kV
Rated insulation voltage U <sub>i</sub>	250 V
Conventional thermal current I <sub>the</sub>	6 A
Rated operating current/voltage I <sub>e</sub> /U <sub>e</sub>	6 A/250 VAC; 0.25 A/230 VDC; 4 A/24 VDC
Utilisation category	AC-15; DC-13
Short-circuit protection	6 A gG/gN fuse
Positive break travel	8 mm
Ambient temperature	-20 °C ... +75 °C

Errors and omissions excepted.



## Safety switch with separate actuator

ST 14 S 2Ö - 2m

Material number: 1053988 (Material number old: 14553707)

### Technical data

Mechanical life > 1 million operations

Approvals



Cable length 2 m

Weight 130 g

### Contact diagram

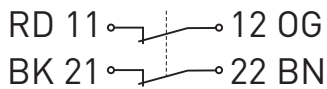

### Switching diagram

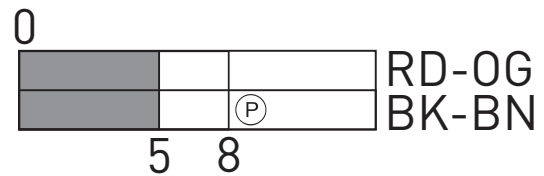

Ⓟ Positive break travel/angle

#### Note

Inserted position of actuator = 0 in switching diagram.  
The actuator is not included with the switches.