



## Position switch with safety function

ES 13 R 1Ö/1S - 2m

Material number: 1044991 (Material number old: 13009901)

### Features/Options:

- Thermoplastic enclosure
- Double insulated
- Suitable for in-line mounting
- With pre-wired cable
- Actuator: Roller plunger R
- Actuating speed max. 0.5 m/s with a vertical actuating angle of 30°
- Metal roller

### Notes

- Actuator can be repositioned by 90° on request

### Dimensions

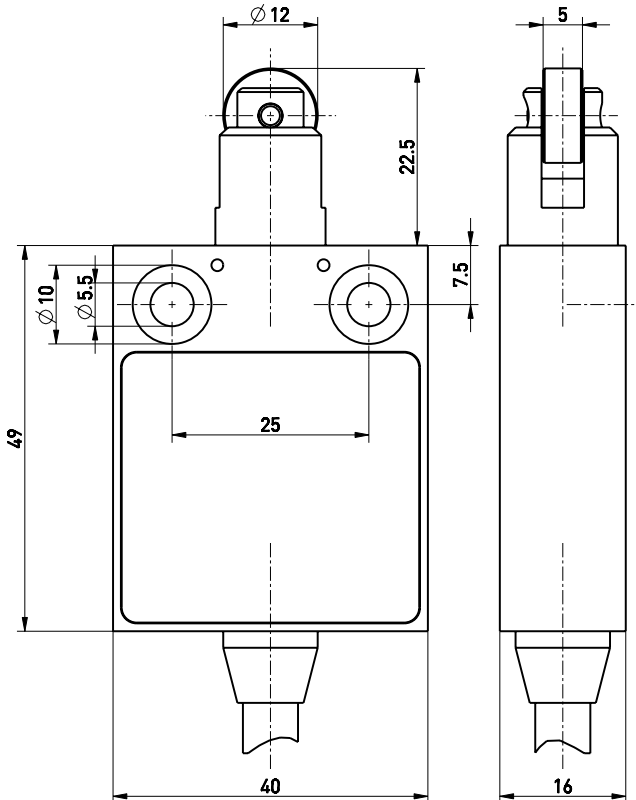

### Technical data

Applied standards	EN ISO 13849-1, EN 60947-5-1, EN ISO 14119
Enclosure	thermoplastic, glass-fibre reinforced, impact resistant, self-extinguishing UL 94 V-0
Switch type	type 1
Coding level	no coding
Tightening torque	enclosure mounting screws: max. 5 Nm
Degree of protection	IP 67 to IEC/EN 60529
$B_{10d}$ (10 % load)	2 million
$T_M$	max. 20 years
Contact material	silver
Switching system	slow action, positive break NC contacts $\ominus$
Switching elements	1 NC/1 NO contact, type Zb
Connection	pre-wired cable H05VV-F
Cable cross-section	4 x 0.75 mm <sup>2</sup>
Cable length	2 m
Rated impulse withstand voltage $U_{imp}$	4 kV
Rated insulation voltage $U_i$	250 V
Conventional thermal current $I_{the}$	6 A
Rated operating current/voltage $I_e/U_e$	6 A/250 VAC; 0.25 A/230 VDC; 4 A/24 VDC
Utilisation category	AC-15; DC-13
Short-circuit protection	6 A gG/gN fuse

Errors and omissions excepted.



## Position switch with safety function

ES 13 R 1Ö/1S - 2m

Material number: 1044991 (Material number old: 13009901)

### Technical data

Ambient temperature -20 °C ... +75 °C

Mechanical life > 1 million operations

Operation cycles max. 1800/h

Repeat accuracy of switching points ± 0.1 mm

Contact opening max. 2 x 4.5 mm

Approvals



Weight 220 g

### Contact diagram

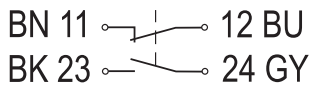

### Switching diagram

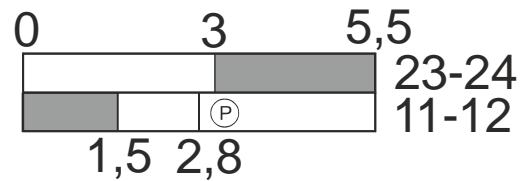

Ⓟ Positive break travel/angle