



## Miniature limit switch

C 50 ST 1Ö/1S

Material number: 1046958 (Material number old: 49005001)

### Features/Options:

- Thermoplastic enclosure
- Actuator: Adjustable plunger ST
- Plunger with knurled-head setting screw

- Length of metal plunger adjustable for fine adjustment of switching travel

### Dimensions

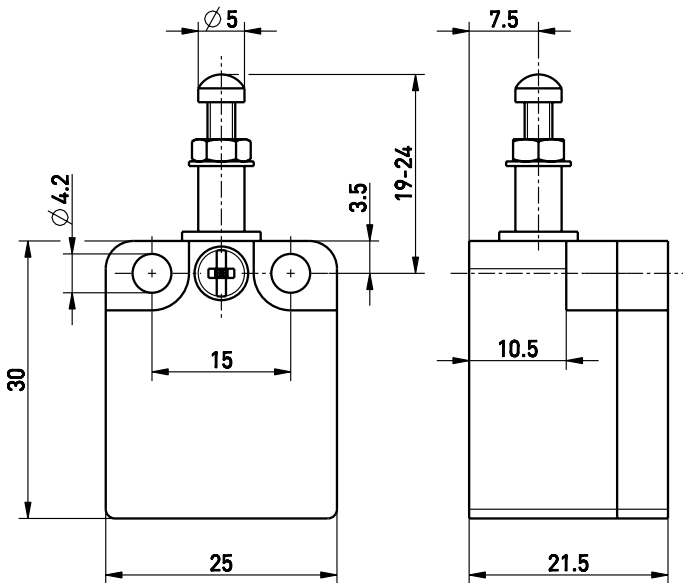

### Technical data

Applied standards	EN ISO 13849-1, EN 60947-5-1
Enclosure	thermoplastic, glass-fibre reinforced, impact resistant, self-extinguishing UL 94 V-0
Actuator	plunger: brass
Tightening torque	enclosure mounting screws: approx. 1 Nm cover screws: approx. 0.6 Nm
Degree of protection	IP 30 to IEC/EN 60529
$B_{10d}$ (10 % load)	500 000
$T_M$	max. 20 years
Degree of pollution	3
Contact material	silver
Switching system	slow action, positive break NC contacts $\ominus$
Switching elements	1 NC/1 NO contact, type Zb
Connection	screw connection terminals
Cable cross-section	max. 1.5 mm <sup>2</sup>
Rated impulse withstand voltage $U_{imp}$	4 kV
Rated insulation voltage $U_i$	400 V
Conventional thermal current $I_{the}$	4 A
Rated operating current/voltage $I_e/U_e$	4 A/400 VAC
Utilisation category	AC-15
Short-circuit protection	4 A gG/gN fuse
Ambient temperature	-20 °C ... +75 °C
Mechanical life	> 1 million operations
Operation cycles	max. 1800/h

Errors and omissions excepted.



## Miniature limit switch

C 50 ST 1Ö/1S

Material number: 1046958 (Material number old: 49005001)

### Technical data

Repeat accuracy of switching points  $\pm 0.1$  mm

Contact opening max. 2 x 4 mm

Approvals



Weight

20 g

### Contact diagram

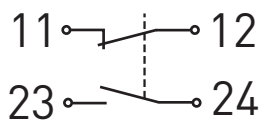

### Switching diagram

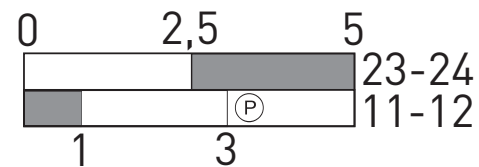

Ⓟ Positive break travel/angle